

# TSUBAKI CABLEVEYOR (Cable Carriers)

Hose and Cable Carrier System



Catalog  
ver.

1



# Tsubaki Cable Carriers — Protecting, Supporting, and Ensuring Reliability

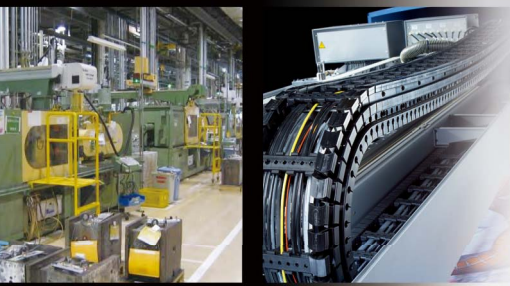

Tsubaki cable carriers and all Tsubaki Group products are compliant with the RoHS directive.

\* CABLEVEYOR is a registered trademark of Tsubakimoto Chain Co.

Tsubaki Group

Basic  
Environmental  
Policy



## Philosophy

The Tsubaki Group Recognize that environmental conservation is one of the most important issues shared by humankind, and seriously considers the environment in all aspects of its global business activities and contributes to the "development of a sustainable society" by generating environmental value and economic value through manufacturing.

## Environmental Policy

1. Reduce environmental impact / We will promote the efficient utilization of energy and resources, reduction of CO<sub>2</sub> emissions and appropriate management of wastes and hazardous chemicals, and work hard to reduce our environmental impact through lifecycles of products and services.
2. Develop and spread eco-products / We will actively develop and spread environmentally friendly products in pursuit of ecology and economy and aim to achieve both environmental conservation and economic benefits.
3. Observe laws and other requirements / We will observe applicable laws, arrangements and other requirements which our organization has agreed to.
4. Improve environmental awareness / We will improve the environmental awareness through environmental education, internal communications and other measures and promote environmentally friendly activities in our own jobs and living places.
5. Promote environmental communication / We will positively disclose appropriate environmental information to our stakeholders to increase social reliability.

# Power to the World!

Tsubaki offers a wide range of products and a global supply system to customers around the world.

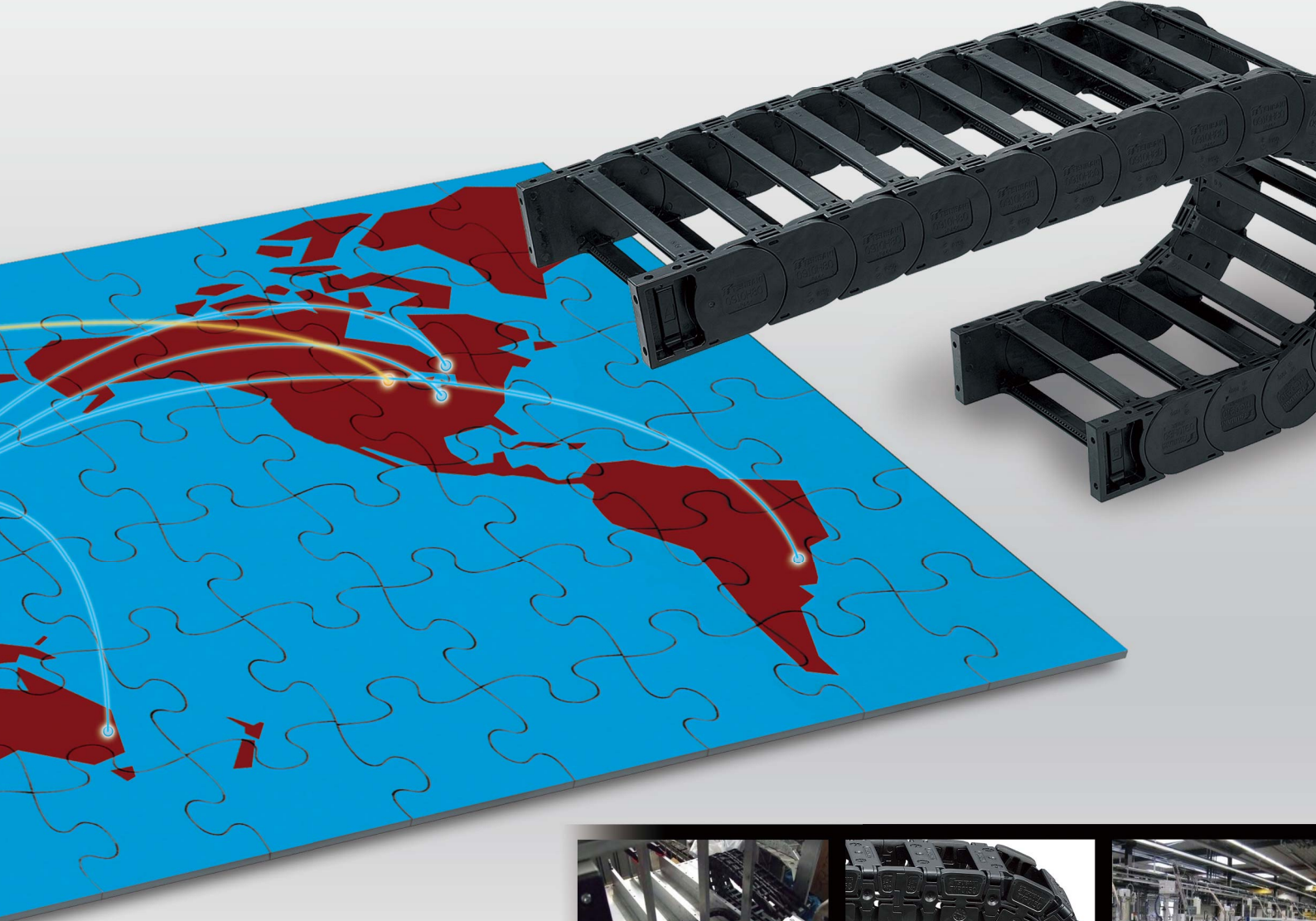

Extensive sales network, services, and technical support

Stable quality and reliable lead time

More than half a century of products and experience



Kyotanabe Plant



Tsubaki-Kabelschlepp-GmbH

# Contents

## Introduction

p. 5

Introduction to Low Debris Generation Products	5
Description of Terms	7
Explanation of Structure	8
Wide variety of models to meet a wide range of needs	9
Products	11
Ordering Information	15

## CLEANVEYOR/FLATVEYOR



p. 22

 CLEANVEYOR	23
 FLATVEYOR	28



## Cable Carrier Plastic Series

p. 34

TKP Series	35
 TKP Series MW Type (Low Friction/Anti-Wear Series)	65
 TKR Series	67
 TKZP Series	77
TKC Series	79

## Cable Carrier Steel Series

p. 94

TK Series	95
TKH Series	103
TKS Series	105
TKF Series	107
TKV Series	111
TKI Series	112



**Cable Carrier TOTALTRAX** p. 114

TOTALTRAX ..... 115

**Cable Carrier Accessories** p. 116

Guide Channels for Gliding Arrangement ..... 117

Support Rollers ..... 119

**Cable Carriers Technical Handbook** p. 120

Applications ..... 121

Examples of Cable Carrier Installations ..... 123

Cable Carrier Special Types ..... 127

Cable Carrier Internal Cross-Section Dimensions ..... 136

Table of Product Masses ..... 143

Cable Carrier Selection ..... 151

Cable Carrier Handling ..... 157

Cable Carrier Connecting/Assembly ..... 160

Cable Carrier Usage Limitations ..... 163

Cable Carrier Inquiries Sheet ..... 164



Tsubaki cable carriers and all Tsubaki Group products are compliant with the RoHS directive.



**TSUBAKI ECOLINK**  
The Tsubaki Group cares about the environment. That is why we have established standards for evaluating the environmental friendliness of our products. Only products that meet our exacting guidelines are recognized as eco-products and certified with the Tsubaki Eco Link logo.

Please consider the cable carrier of **TSUBAKI KABEL SCHLEPP**, our group company.

**Catalog**

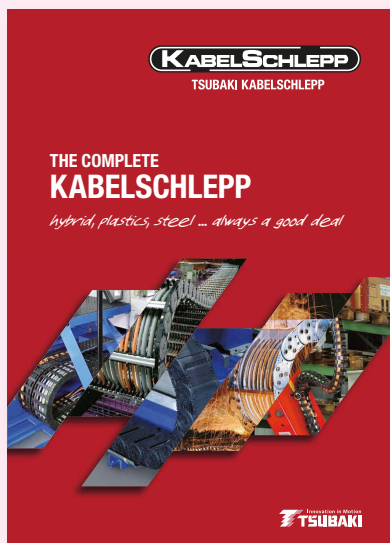

**Website**

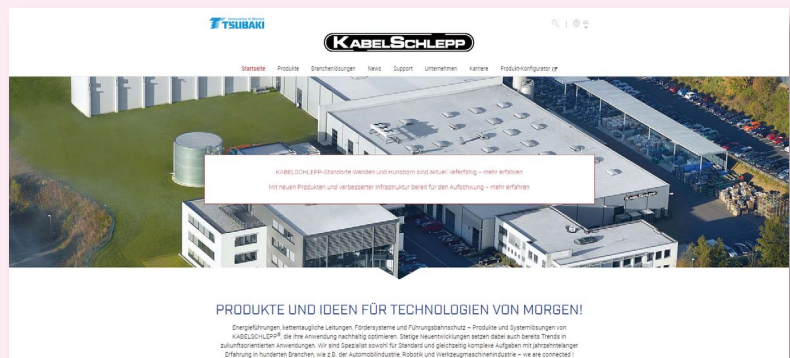

kabelschlepp

**Search!!**

# Tsubaki offers low debris generation products

## FLATVEYOR



Clean class **ISO class 2** <sup>★1</sup> achieved

**Low debris generation with free-standing flat cable structure.**



Support members allow for a maximum travel length of up to 2.8 m <sup>★2</sup>

Support Member + Built-in Flat cable → Free-standing

**Deflection comparison between flat cable and Flatveyor**

Flat cable (competitor) → FLATVEYOR (Tsubaki)

Equipped with support members to minimize bouncing.

**Bouncing comparison between flat cable and FLATVEYOR**

Flat cable (competitor) → FLATVEYOR (Tsubaki)

# for different operating environments.

## CLEANVEYOR



Page 23



Clean class **ISO class 1** <sup>★1</sup> achieved

**Top-class low debris generation through the use of fluoroplastic pods.**



## TKR Series



Page 67



Clean class **ISO class 3** <sup>★3</sup> achieved

**Low debris generation thanks to Tsubaki's unique structure.**

No sliding wear between pins and pin holes and the use of highly wear resistant material with high slidability delivers the low debris generation.

In-house test conditions  
• Installation: Standard (with floor)  
• Travel speed: 120 m/min \*No supports  
\* Debris generated indicates the number of particles 0.1 μm or larger that exist in one cubic foot.

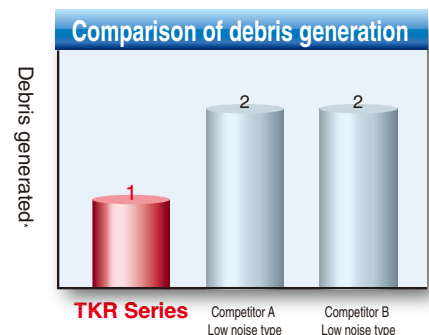

- ★1. Based on test results by Germany's Fraunhofer Institute for Manufacturing Engineering and Automation (IPA) in accordance with ISO 14644-1 "Classification of air cleanliness by particle concentration."
- ★2. Depending on operating conditions.
- ★3. Based on in-house test results in accordance with ISO 14644-1 "Classification of air cleanliness by particle concentration" (travel speed 120 m/min).

# Description of Terms/Structure

Cable carriers are devices where electric cables and hydraulic/pneumatic hoses are installed inside so that they can be reliably supported and guided between moving equipment and their fixed end. The articulating areas bend only in one direction and at a constant radius.

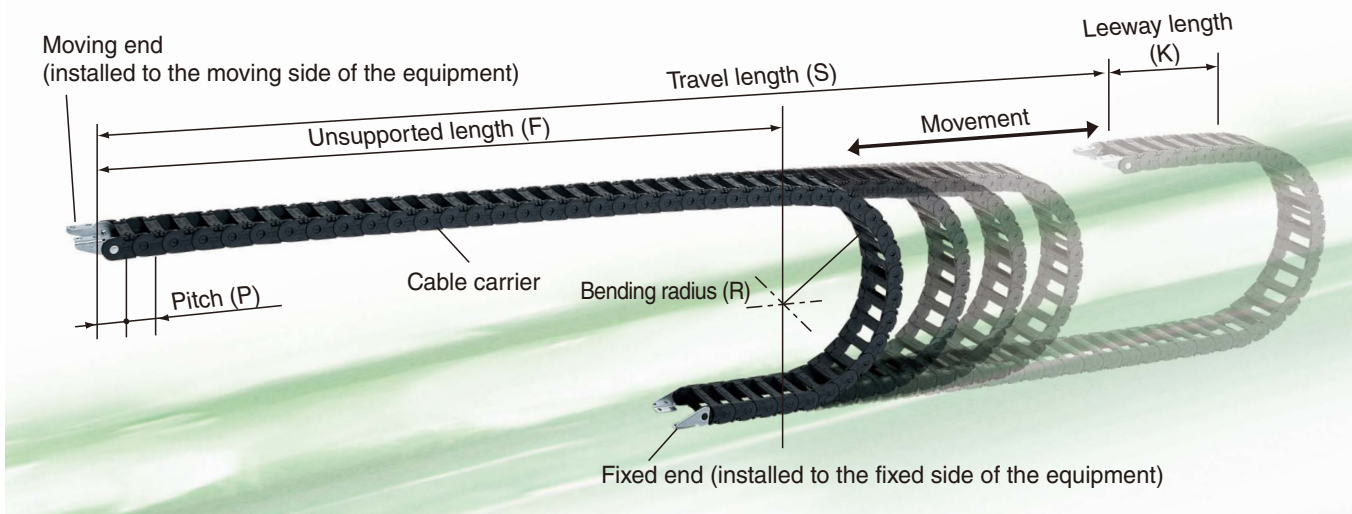

The cables and hoses that deliver the power and signals are needed to move the equipment. When cables and hoses move freely with the movement of the equipment, the cables and hoses are exposed to excessive forces such as twisting and tension. The setup will also appear cluttered.

Tsubaki cable carriers install cables and hoses inside the cable carrier and provide steady, reliable support and guidance without exposing cables and hoses to excess forces. Cable carriers also protect cables and hoses with bending limit and keep cables and hoses on a defined path.

## Unsupported length (F)

The distance from the moving end to the peak of the bending section. This is length that is self supported. The allowable length is determined by the model. Check the load diagram on each product page.

## Travel length (S)

The movement distance between two points where the moving end of the cable carrier (moving part of the equipment) completes one cycle.

## Leeway length (K)

The leeway length the cable carrier has to absorb any differences in installation dimensions. The leeway length depends on the model. Check the "Calculating no. of links" item on each product page.

## Bending radius (R)

The cable carrier bends in a fixed direction at a constant radius. This radius is referred to as the bending radius. The bending radius depends on each model. Check the list of products (pages 11 to 14) or check each product page.

## Load diagram

The load diagram shows the allowable range of the unsupported length and travel length for the cable/hose mass (kg/m). The cable carrier can be used if the operating conditions fall within the range of the dashed lines.

The load diagram depends on the model. Check the load diagram on each product page when selecting products.

## Total height (H)/mounting height (H')

Total height (H): The height from the outside surface of the fixed end bracket to the peak of the bending section (outside).  
Mounting height (H'): The height from the outside surface of the fixed end bracket to the outside surface of the moving end bracket.

To compensate for sag in the unsupported length section caused by the cable carrier's weight and cable/hose mass, the cable carrier has a structure given pretension.

If the cable carrier is installed at the total height, the pretension will be constrained and an excessive force will act on the cable carrier. This may reduce the service life of the cable carrier, so always use the mounting height when designing the equipment and installing the cable carrier.

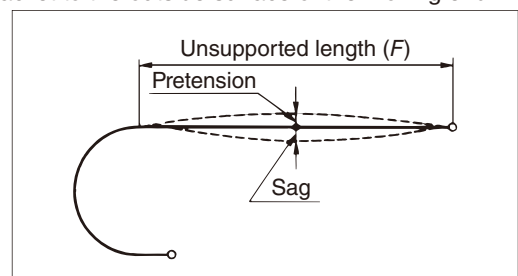



## Required space ( $h$ )/leeway space ( $S$ )

Required space ( $h$ ) is the space required to install the cable carrier in the equipment. Include the leeway space ( $S$ ) to prevent the cable carrier from hitting the equipment due to pretension, chordal action, and flopping during movement. Check the calculation method on page 157.

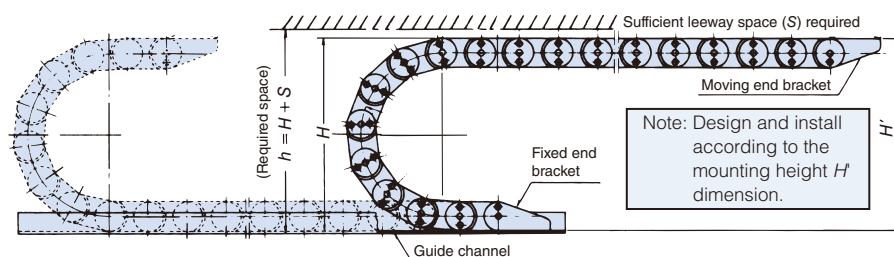

## Explanation of Structure

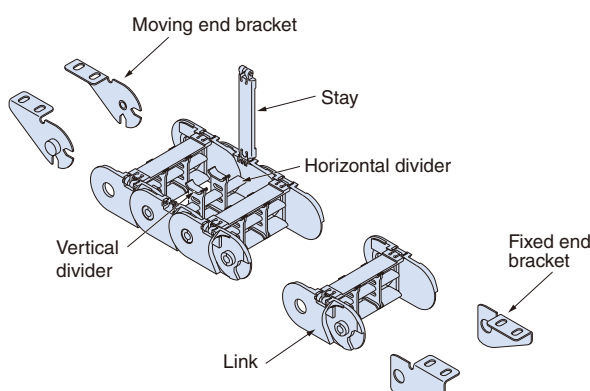

## Links

The cable carrier body is composed of links and stays and is the part that installs cables and hoses. It has a function where it bends in one direction only at a constant radius. There are different types of openable stay structures, and these include the outside openable stay and inside openable stay.

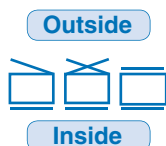

For the type that opens both to the inside and outside, the inside stay is called a lock stay.

## Brackets/steel brackets

These are parts for mounting the cable carrier on the equipment. Plastic parts are called brackets and metal parts are called steel brackets. There are various types depending on the structure and mounting method. The applicable types depend on each cable carrier. Check the product pages for further information. Page 16 shows images of the structures.

## Divider

Dividers are parts that divide up the installing space inside the cable carrier.

**Vertical dividers:** Horizontally divide the installing space inside the cable carrier. There are sliding types and fixed types. Dividers are normally installed every 2 links.

**Horizontal dividers:** Vertically divide the installing space inside the cable carrier. There are types that divide the entire space and types that divide part of the space. 2 or more vertical dividers are required when using a horizontal divider.

The lineup of dividers depends on each cable carrier model. Check the product pages for further information. In addition, refer to the operating precautions on page 153.

# Wide variety of models to

Open

## TKZP Series



Zipper structure,  
cuts easily to  
the required length

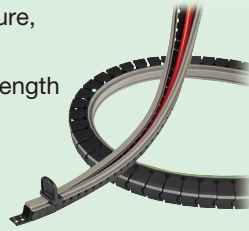

## TKQT Series / TKET Series



Easy cable installation,  
stays won't fall off

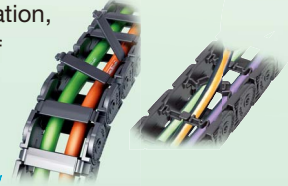

## TKUA

Complementary products for the  
TKP lineup with strain relief  
comb\* and increased quietness

## TKS Series

Simple stay capability

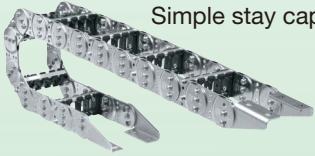

## TKLS Series

Lightweight type



## TK Series / TKH Series

Highly durable

Increased protection of  
cables and hoses  
thanks to stays



## TKP

Standard open type

Anti-dust

## TKV Series

High-speed,  
high-frequency

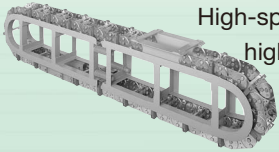

## TKI Series

High-speed, long-length

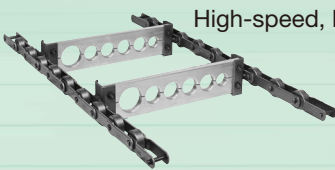

## TKC

Standard  
closed type

## TKA

Complementary products for  
the TKC lineup with  
strain relief comb\* and  
increased quietness

## TKF Series

Steel Series  
closed type

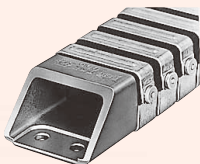

Plastic Series

Steel Series

3D Series

\* Cable/hose brackets and clamps

Closed

# meet a wide range of needs

type

## TKMK Series

Wide variety of models



## TKHC Series , TKLC Series , TKXC Series

Variable width (1 mm increments), strain relief comb\*



## TKQ Series

Quiet, smooth operation

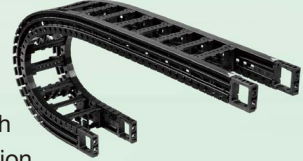

## Series

Variable sizes



## TKP Series, MW Type

Improved protection of cables and hoses



## FLATVEYOR

Low debris generation with flat cable structure



## Series

Clean



## TKR Series

Quiet, low debris generation



## CLEANVEYOR

Top-class low debris generation

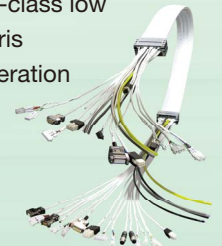

## Series

3D

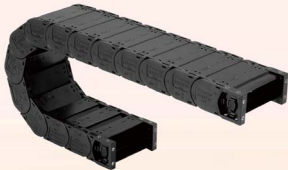

## TKRB Series

Easy cable installation



## Series

## FTP Series

3D closed type



## TKLT Series / TKXT Series

Variable width (1 mm increments), strain relief comb\*



## TKMT Series

Wide variety of models



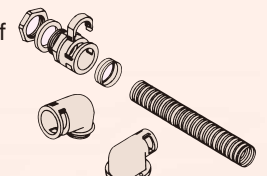

## PMA Series

3D waterproof closed type















type

# Cable Carrier Plastic Series Products

Type	Product series	Model	 Inner height (mm)	 Inner width (mm)	 Bending radius (mm)
Open type	<b>TKP Series</b> Wide selection and easy-to-handle products—from compact to large sizes.	<b>TKP13H10</b>	10	6/10/15/20: Openable stay 6/10/15/20: Single-part frame	18/20/28/37
		<b>TKP17H11</b>	11	10	17
		<b>TKP18H14</b> <b>TKP18H15</b>	14/15	15/20/30/40: Openable stay 15/20/30/40: Single-part frame	28/37/50
		<b>TKP25H15</b>	15	15/20/30	28/37/50
		<b>TKP35H22</b>	22	13/25/38/50/63	37/50/75/100
		<b>TKP35H32</b>	32	16/25/38/50	48/60/75/100/125
		<b>TKP45H25</b>	25	38/58/78/103	50/75/95/125/150/200
		<b>TKP58H39</b>	39	50/75/100/125	60/75/90/125/150/200
		<b>TKP62H34</b>	34	150/200	75/90/125/150/200
		<b>TKP68H46</b>	46	75/100/125/150/175	75/100/125/150/200/250
		<b>TKP90H50</b>	50	100/150/200	130/200/250/300
		<b>TKP91H56</b>	56	150/175/200/225/250/275 300/325/350/400/450/500	150/200/250/300/350/400
		<b>TKP91H80</b>	80	150/175/200/225/250/275 300/325/350/400/450/500	150/200/250/300 350/400/450/500
	<b>TKP125H74</b>	74	150/250/350	185/250/350/450	
	<b>TKP Series, MW Type</b> (Low Friction/ Anti-Wear Series) TKP Series products with better protection of cables and hoses and improved cleanliness.	<b>TKP13H10xxM</b>	10	10/20	18/28/37
		<b>TKP18H14xxM</b>	14	15/40	28/37/50
		<b>TKP25H15xxM</b>	15	15/20/30	28/37/50
		<b>TKP35H22xxM</b>	22	13/25/38/50/63	37/50/75/100
		<b>TKP35H32xxM</b>	32	16	60/75/100/125
		<b>TKP45H25xxM</b>	25	38/58/78/103	50/75/95/125/150/200
<b>TKR Series</b> Top-of-its-class quietness and low debris generation. Optimal for clean environments.	<b>TKR15H22</b>	22	20/40/60	40/50/75	
	<b>TKR20H28</b>	28	30/40/50/60/80/100/120	55/75/95/150	
	<b>TKR26H40</b>	40	50/62/75/87/100/125/150/200	75/100/125/150	
	<b>TKR28H52</b>	52	50/62/75/87/100/125/150/200	75/100/150/200	
	<b>TKR37H28</b>	28	40/50/60/70/80	55/75/100	
<b>TKZP Series</b>	<b>TKZP10H13</b>	13	10/15/20/25	Minimum bending radius: 50	
Closed type	<b>TKC Series</b> Protects cables/hoses from debris or spatter and provides high strength and rigidity.	<b>TKC28H30</b>	30	28/48	67/100/125
		<b>TKC34H25</b>	25	50/90/130	70/100/150
		<b>TKC47H36</b>	36	80/160	100/150/200/250
		<b>TKC64H50</b>	50	110/220	135/200/250/300
		<b>TKC85H68</b>	68	150/200/300/350	180/250/350
		<b>TKC91H56</b>	56	150/200/250/300/350/400	200/250/300/350/400
		<b>TKC91H80</b>	80	150/200/250/300/350/400	200/250/300/350/400/450/500

★1. The maximum outer diameter of cable and hose for the bending radius will vary by cable or hose. Contact your cable or hose manufacturer for further information.





★2. Refer to the explanation of the marks on page 14.

Pitch (mm)	Maximum travel length (m)	Cable/hose maximum outer diameter *1 (mm)	Cable/hose maximum mass (kg/m)	Special types		Opening options *2								Dividers *2			See page	
				Gliding arrangements 	Circular travel arrangement 									Vertical divider 	DSA 	DSB 		
13	1.3 (R18, R20: 1.0)	8 (W6: 4)	0.4		●	●	●	●										35
17	1.2	7	0.4			●												38
18	1.75 (R28: 1.5)	12	1		●	●	●	●										39
25	1.75 (R28: 1.5)	12	1		●		●	●										43
35	2.7 (R37, R50: 2.3)	20 (W13: 11)	2	●	●			●	●			●	●					45
35	2.3 (R48, R60: 2.0)	28 (W16: 13, W25: 22)	2					●	●			●	●					47
45	3.3 (R50: 2.8, R75, R90: 3.2)	22	4	●	●			●	●			●	●	●				49
58	4.3 (R60: 3.9)	35	8	●	●			●	●			●	●	●				51
62.5	4.4	31	12	●	●					●		●	●	●				53
68	4.8	41	12	●	●			●	●			●	●	●				55
90	5.2	44	18	●	●					●		●	●	●				57
91	6.8	50	50	●	●							●	●	●	●			59
91	8.8	72	60	●	●							●	●	●	●			61
125	7.2	67	45	●	●					●		●	●	●				63
13	1.0 (R18: 0.8)	8	0.4		●		●											65
18	1.4 (R28: 1.2)	12	1		●		●											
25	1.4 (R28: 1.2)	13	1		●		●	●										
35	2.2 (R37, R50: 1.8)	19 (W13: 11)	2		●			●	●			●	●					
35	1.8 (R60: 1.6)	14	2		●			●										
45	2.6 (R50: 2.3, R75, R90: 2.5)	22	4.5		●			●	●			●	●					
15	1.77	20 (W20: 18)	2					●				●	●					67
20	2.76 (R50: 2.46)	25	2.4								●	●	●					69
26	3.95	36	8								●	●	●	●				71
28	4.94	47	10								●	●	●	●				73
37	2.65	25	2.4								●	●	●					75
10	1.0	6	0.2 (W10, W15: 0.1)															77
28	2.7	25	2				●					●	●					79
34	3.3	22	12	●	●							●						81
47	4.3	32	17	●								●						83
64	5.8	44	25	●								●	●	●				85
85	7.8	60	60	●								●	●	●				87
91	6.8	50	50	●								●	●	●				89
91	8.8	72	60	●								●	●	●				91

Cable Carrier Plastic Series Common Specifications

1. Maximum travel speed : 300 m/min (TKP17H11: 150 m/min, TKZP Series: 100 m/min, support roller arrangement: 150 m/min)
2. Operating temperature : -40°C to 80°C (TKP Series MW Type: -20°C to 80°C, TKZP Series: 10°C to 80°C)
3. Operating environment : Cannot be used in acidic or alkaline environments. Refer to the data for chemical-resistant products. Usage in an outdoor environment is possible, but protect the cable carrier from wind, rain, snow, and dust with a cover or by other means. The stainless steel type is also recommended for steel parts. Be aware that the cable carrier cannot be used when frozen.

# Cable Carrier Steel Series Products



Type	Product series	Model	 Inner height (mm)	 Inner width (mm)	 Bending radius (mm)	 Pitch (mm)	 Maximum travel length (m)
Open type	<b>TK Series</b> High strength/rigidity. Steel cable carriers with superior heat resistance.	<b>TK070</b>	Custom dimensions	Custom dimensions	75/90/125/145	70	6.7
		<b>TK095</b>			125/145/200/250/300	95	8.7
		<b>TK130</b>			200/250/300/400	130	11.6
		<b>TK180</b>			250/300/400/500/600/700	180	15.7
	<b>TKH Series</b> Can be used in high-load, low-frequency applications.	<b>TKH250</b>	Custom dimensions	Custom dimensions	350/450/600/750	250	22
	<b>TKS Series</b> Can be used more affordably than the TK Series.	<b>TKS070</b>	31	100/150/200	75/90/125/145	70	6.7
<b>TKS095</b>		46	100/150/200	125/145/200/250/300	95	8.7	
Closed type	<b>TKF Series</b> Fully closed structure protects cables and hoses from dust and spatter.	<b>TKF055</b>	25	45	60/100/150	20	2.7
		<b>TKF085</b>	38	74	100/200/250	20	3.7
		<b>TKF115</b>	52	102	140/225/300	25	4.7
		<b>TKF175</b>	72	162	185/250/350	30	5.2
Heavy load	<b>TKV Series</b> Can be used in high-speed, high-frequency applications.	<b>TKV130</b>	Custom dimensions	Custom dimensions	200/250/300/400	130	30
	<b>TKI Series</b> Can be used high-speed, long-length applications.		-	Custom dimensions	175/200/250/300/350/400/500	-	100

★1. The maximum outer diameter of cable and hose for the bending radius will vary by cable or hose. Contact your cable or hose manufacturer for further information.

★2. Refer to the explanation of the marks on page 14.

#### Cable Carrier Steel Series Common Specifications

- Maximum travel speed : 60 m/min (TKV Series: 150 m/min, TKI Series: 120 m/min)
- Operating temperature : -10°C to 150°C (TKS Series, TKF Series, TKV Series: -10°C to 80°C)
- Operating environment : Cannot be used in acidic or alkaline environments. Refer to the data for chemical-resistant products.  
Usage in an outdoor environment is possible, but protect the cable carrier from wind, rain, snow, and dust with a cover or by other means. The stainless steel type is also recommended for steel parts. Be aware that the cable carrier cannot be used when frozen.
- For the TK Series and TKH Series, contact a Tsubaki representative if the link plates must be stainless steel or if the stays must be engineering plastic.  
Link plates can be SUS304 and pins can be SUS630 (tempered).

Cable/hose maximum outer diameter (mm)	Cable/hose maximum mass (kg/m)	Materials			Divider system *2			See page
		Chain	Stay/frame	Bracket	Unsplit stay 	Split stay 	Vertical divider 	
27	50	Steel (Trivalent chromate plating)	Aluminum	Steel (Trivalent chromate plating)	●	●		95
46	60				●	●		97
60	70				●	●		99
80	80				●	●		101
110	100	Steel (Trivalent chromate plating)	Aluminum	Steel (Trivalent chromate plating)	●	●		103
27	10	Steel (Trivalent chromate plating)	Aluminum/steel/ engineering plastic	Steel (Trivalent chromate plating)			●	105
42	10						●	106
22	12	Galvanized steel plate (Upper/lower frame)/ Engineering plastic (Middle frame)		Aluminum				107
35	21.5							108
48	30							109
60	40							110
60	50	Steel	Aluminum	-	●	●		111
80	100	Steel	Aluminum	-	●	●		112

◆ Explanation of marks

\*1

Opening options

 Single-part frame (cannot be opened)

 Outside detachable stay

 Outside single-sided openable stay

 Outside dual-sided openable stay

 Inside dual-sided openable stay

 Outside single-sided openable stay, inside detachable lock stay

 Outside dual-sided openable stay, inside detachable lock stay

 Outside detachable stay and inside detachable lock stay

\*2

Dividers and divider systems

 Vertical dividers only

 DSA type (Fully-stayed multiple height separation)

 DSB type (Partial multiple height separation)

 Unsplit stay type

 Split stay type

# Ordering Information

When ordering cable carriers, you need to specify the product series code and dimensions, as well as information about the length (number of links) and brackets/steel brackets on both ends. This section introduces the basic configuration for model number and ordering examples. Contact a Tsubaki representative about made to order cable carriers.

## 1. Basic configuration of model number

Cable carriers have the model number configuration shown in the following examples (excluding certain models).

### ◆ Model number: Cable carrier (links + brackets/steel brackets)

**TKP 45 H 25 - 30 W 58 R 50 + 20 L - FOA - MOA** **1 set**<sup>(cable carrier)</sup>  
 (1) (2) (3) (4) (5) (6) (7) (8) (9) Qty. Unit

### ◆ Model number: Brackets/steel brackets (individual)

**TKP 45 H 25 - FOA** **1 pcs**  
 (1) (2) (3) (8) Qty. Unit

### ◆ Model number: Vertical/horizontal divider (individual)

**TKP 45 H 25 - ST** **14 pcs**  
 (1) (2) (3) (10) Qty. Unit

(1) Product series code	Indicates the product series as a code.
(2) Pitch	Indicates the pitch per link. (Expressed as an integer in the model number.)
(3) Inner height	Indicates the inner height of the cable carrier.
(4) Opening options	Indicates whether or not the stay opens and the type of structure as a number. Examples ◆ TKP Series, TKZP Series, TKC Series 20 = Single-part frame (stay cannot be opened) 30 = Outside openable stay 40 = Inside openable stay
(5) Inner width	Indicates the inner width of the cable carrier.
(6) Bending radius	Indicates the bending radius of the cable carrier.
(7) Number of links	Indicates the number of links per cable carrier. (Not including brackets/steel brackets)
(8) Fixed end bracket code	Indicates the variants of the bracket/steel bracket to install on the fixed end. (Refer to page 16.)
(9) Moving end bracket code	Indicates the variants of the bracket/steel bracket to install on the moving end. (Refer to page 16.)
(10) Divider type	Indicates the divider type as a code.

Notes: There are differences in the model number configuration and selectable types for each model. Refer to the individual product pages for further information.

1. For "(4) Opening options," the types and notation differ for each model.

2. For "(5) Inner width" and "(6) Bending radius," the selectable range differs for each model.

3. For "(8) Fixed end bracket code" and "(9) Moving end bracket code," the applicable types differ for each model.





# Ordering Information

## 3. Ordering examples (Plastic Series: Basic examples)

Cable carrier (cable carrier plastic links + steel brackets for both ends)

### ➔ Ordering example

To order one TKP45H25-30W58R50 with 20 links, a fixed end bracket (outside mounting with connection surface inside), and a moving end bracket (outside mounting on cable carrier/inward mounting for equipment)

Model number	Quantity
<b>TKP45H25-30W58R50+20L-FOA-MOA</b>	<b>1 set</b>

Cable carrier (cable carrier plastic links + steel brackets for one end)

### ➔ Ordering example

To order one TKP45H25-30W58R50 with 20 links, a fixed end bracket (outside mounting with connection surface inside), and no a moving end bracket

Model number	Quantity
<b>TKP45H25-30W58R50+20L-FOA</b>	<b>1 set</b>

Cable carrier (cable carrier plastic links only)

### ➔ Ordering example

To order one TKP45H25-30W58R50 with 20 links (no fixed end/moving end brackets)

Model number	Quantity
<b>TKP45H25-30W58R50+20L</b>	<b>1 set</b>

Bracket/steel bracket (when ordering individual parts)

### ➔ Ordering example

To order one fixed end bracket (inside mounting with connection surface inside) to install on a model TKP45H25-30W58R50 cable carrier plastic links

Model number	Quantity
<b>TKP45H25-FIA</b>	<b>1 pcs</b>

Divider

### ➔ Ordering example

To order dividers installed to the cable carrier ordered in the example of "1. Cable carrier (cable carrier plastic links + brackets/steel brackets for both ends)"

Vertical dividers: Sliding type  
Horizontal dividers: DSA type (fully stayed)

Model number	Quantity
<b>TKP45H25-ST</b>	<b>20 pcs</b>
<b>TKP45H25-HS58</b>	<b>10 pcs</b>

Notes: 1. Install dividers every 2 links.  
2. When installing a horizontal divider, always install 2 or more vertical dividers per link.  
3. Dividers are delivered uninstalled.

#### 4. Ordering examples (Plastic Series: Specific examples)

This section introduces concrete ordering methods for models that require special attention when ordering.

##### TKR Series (TKR15H22)

###### ➔ Ordering example

To order one TKR15H22-30W20R40 with 24 links, a fixed end bracket (outside mounting on cable carrier), and a moving end bracket (outside mounting on cable carrier)

Model number	Quantity
<b>TKR15H22-30W20R40+24L-FO-MO</b>	<b>1 set</b>

Note: Due to its structure, model TKR15H22 must always be ordered with an even number of links.

###### ➔ Ordering example (for extension)

To order four links to extend a TKR15H22-30W20R40 cable carrier

Model number	Quantity
<b>TKR15H22-30W20R40ETL+4L</b>	<b>1 set</b>

Note: Due to its structure, model TKR15H22 must always be ordered with an even number of links.

# Ordering Information

## 4. Ordering examples (Plastic Series: Specific examples)

### Gliding Arrangement

The model number configuration for the gliding arrangement differs according to the gliding shoe installation conditions. Check the gliding shoe installation conditions in "Gliding shoe installation" on page 129 and refer to the ordering example that matches the installation conditions.

Contents described in "Gliding shoe installation"

- "– (None)" → Refer to ordering example 1
- "△ (Optional)" → Refer to ordering example 1
- "● (Required)" → Refer to ordering example 2

#### ➔ Ordering example 1

To order one TKP45H25-30W58R50 in the gliding arrangement with 100 links (fixed end bracket (outside mounting with connection surface inside) and moving end bracket (outside mounting with connection surface inside))

Model number	Quantity
<b>TKP45H25-30W58R50+100L-FOA-MOAGA</b>	<b>1 set</b>

Note: The special gliding arrangement moving end bracket may be required depending on the combination of model and bending radius. Check "Moving end bracket - Type" on page 129. If the special gliding arrangement moving end bracket is required, add "GA" to the end of the code for the moving end bracket.

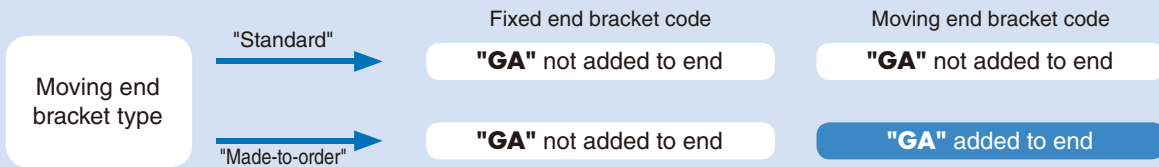

#### ➔ Ordering example 2

To order one TKP91H56W150R200 in the gliding arrangement with 100 links (fixed end bracket (outside mounting with connection surface inside) and moving end bracket (outside mounting with connection surface inside))

Model number	Quantity
<b>TKP91H56W150R200-GA+100L-FOAGA-MOAGA</b>	<b>1 set</b>

Notes: 1. Add "-GA" after the bending radius (R200).  
 2. The special gliding arrangement moving end bracket may be required depending on the combination of model and bending radius. Check "Moving end bracket - Type" on page 129. If the special gliding arrangement moving end bracket is required, add "GA" to the end of each code for the fixed end/moving end bracket. If using the standard moving end bracket, add "GA" to the end of the code for the fixed end bracket because only that bracket is a special gliding arrangement part.

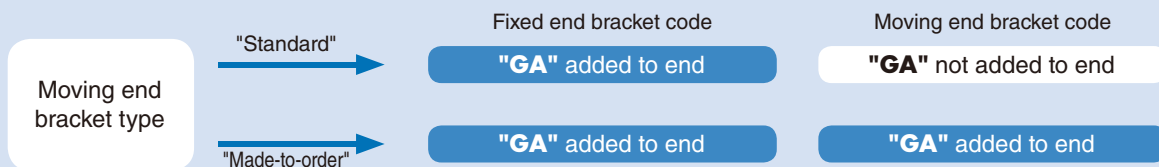

## 5. Ordering examples (Steel Series)

### TKS Series

#### ➔ Ordering example

To order one TKS070 in the 100 mm frame width and 75 mm bending radius type with 35 links, a fixed end bracket (outside mounting with connection surface inside), and a moving end bracket (outside mounting with connection surface inside)

Model number	Quantity
<b>TKS070SP100R75+35L-FOA-MOA</b>	<b>1 set</b>

Notes: 1. Dividers must be installed when using frame widths of 150 mm and 200 mm (refer to the individual product pages for further information). Order dividers separately.  
2. Frames are required when using the TKS Series as a cable carrier. However, when frames are not required, delete "SP□□" in the model number when ordering.

### TKF Series

#### ➔ Ordering example

To order one TKF085 in the 100 mm bending radius type with 80 links, a fixed end bracket (A type, outside mounting on cable carrier), and a moving end bracket (B type)

Model number	Quantity
<b>TKF085R100+80L-KGAO-KGB</b>	<b>1 set</b>

Note: Brackets/steel brackets are delivered installed.

### TK Series/TKH Series

#### ➔ Ordering example

To order one TK095R125 with 35 links, a fixed end bracket (outside mounting with connection surface inside), and a moving end bracket (outside mounting with connection surface inside)

In addition, to order 17 split stay (height 50 mm, width 125 mm, thickness 15 mm)

Model number	Quantity
<b>TK095R125+35L-FOA-MOA</b>	<b>1 set</b>
<b>TK095-SP50-125-15B-TK</b>	<b>17 pcs</b>

Note: Specify the stay bore diameter and distance between stay bores (refer to pages 95 to 104 for the specification method).



# CLEANVEYOR/FLATVEYOR

## CLEANVEYOR

CLEANVEYOR .....23

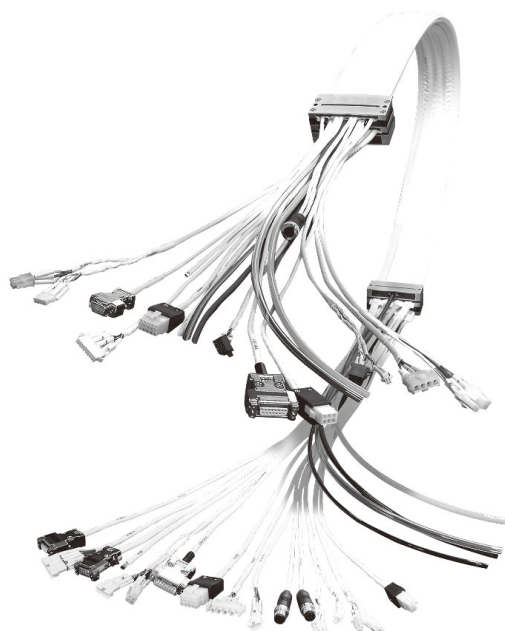

## FLATVEYOR

FLATVEYOR .....28



## Structure

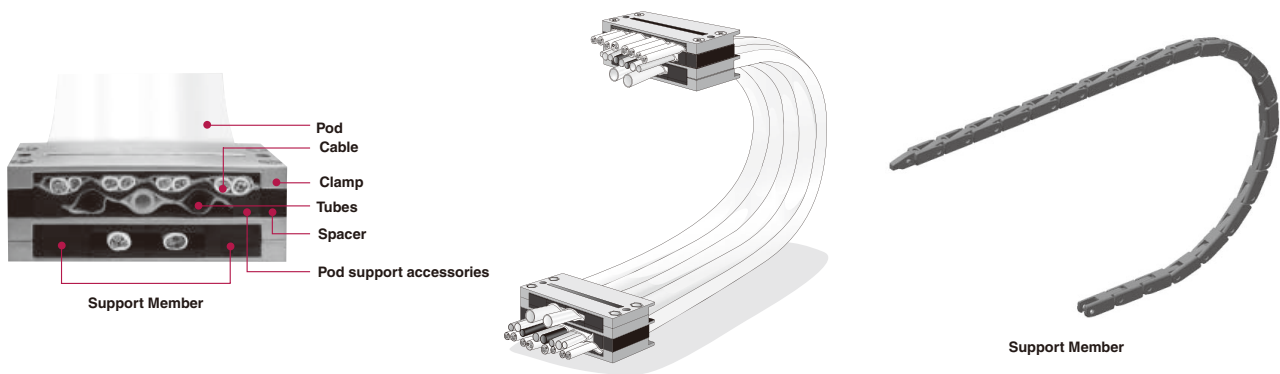

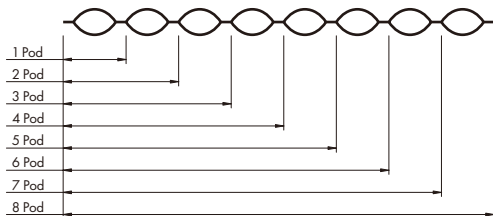

## Pod types and dimensions



No. of pods	Pod thickness * (mm)	Pod width * (mm)	Connection width * (mm)	Total width (mm)
1Pod	1	19	2.3	23.6
2Pod				44.9
3Pod				66.2
4Pod				87.5
5Pod				108.8
6Pod				130.1
7Pod				151.4
8Pod				172.7

Note: ★ The dimensions of the pod when it is flat (closed). The dimensions given are nominal dimensions and may differ from the actual dimensions.

Cable/tube outer diameter (mm)	Installable No. of cables/tubes/Pod	Installation image
Outer diameter ≤ 4.0	3	
4.0 < Outer diameter ≤ 6.3	2	
6.3 < Outer diameter ≤ 10	1	

## Clamp types and dimensions

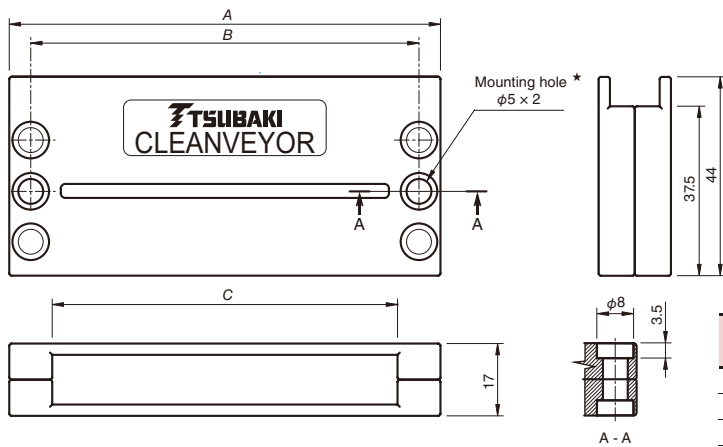

Note: ★ Use bolt with hole M4 to fasten the clamps to the equipment.

Clamp type	A (mm)	B (mm)	C (mm)
2Pod	57.2	47.7	38.2
3Pod	76.3	66.8	57.3
4Pod	95.4	85.9	76.4
5Pod	114.5	105.0	95.5
6Pod	133.6	124.1	114.6
7Pod	152.7	143.2	133.7
8Pod	171.8	162.3	152.8



## Basic specifications/capacities

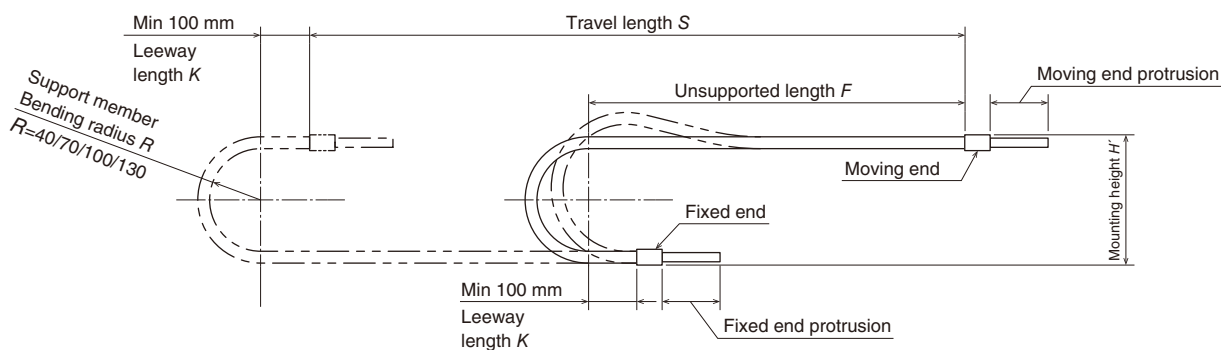

Maximum travel length *1 (mm)	Support member Bending radius R40 ..... 1600 Support member Bending radius R70 ..... 2200 Support member Bending radius R100 ..... 2800 Support member Bending radius R130 ..... 2800
Maximum cable length (mm)	8000
Maximum travel speed (m/sec)	2
Maximum acceleration (G)	4
Operating temperature range (°C)	-10 to 80
Minimum/maximum cable/tube outer diameter (mm)	3 to 10

Pod	Fluoroplastic (ePTFE)	
Cable	Conductor	Tinned annealed copper wire or annealed copper wire
	Insulator	Fluoroplastic (FEP, ETFE, PFA) or thermoplastic polyester elastomer (TPEE)
	Binder	Fluoroplastic (ePTFE)
	Shield	Tinned annealed copper wire
	Sheath	PVC LF (lead free)
Support Member	Engineering plastic	
Clamp	Aluminum	
Spacer	Engineering plastic	
Pod support accessories	PVC	

Notes: ★ 1. When additional load is 0.4 kg/m.  
2. Support member-Bending radius and bending radius when installing the CLEANVEYOR may differ.

Note: Sheet of Ultra-High Molecular Weight Polyethylene (UHMW-PE) for sticking on the installation surface of CLEANVEYOR is attached at the time of delivery.

## Selection



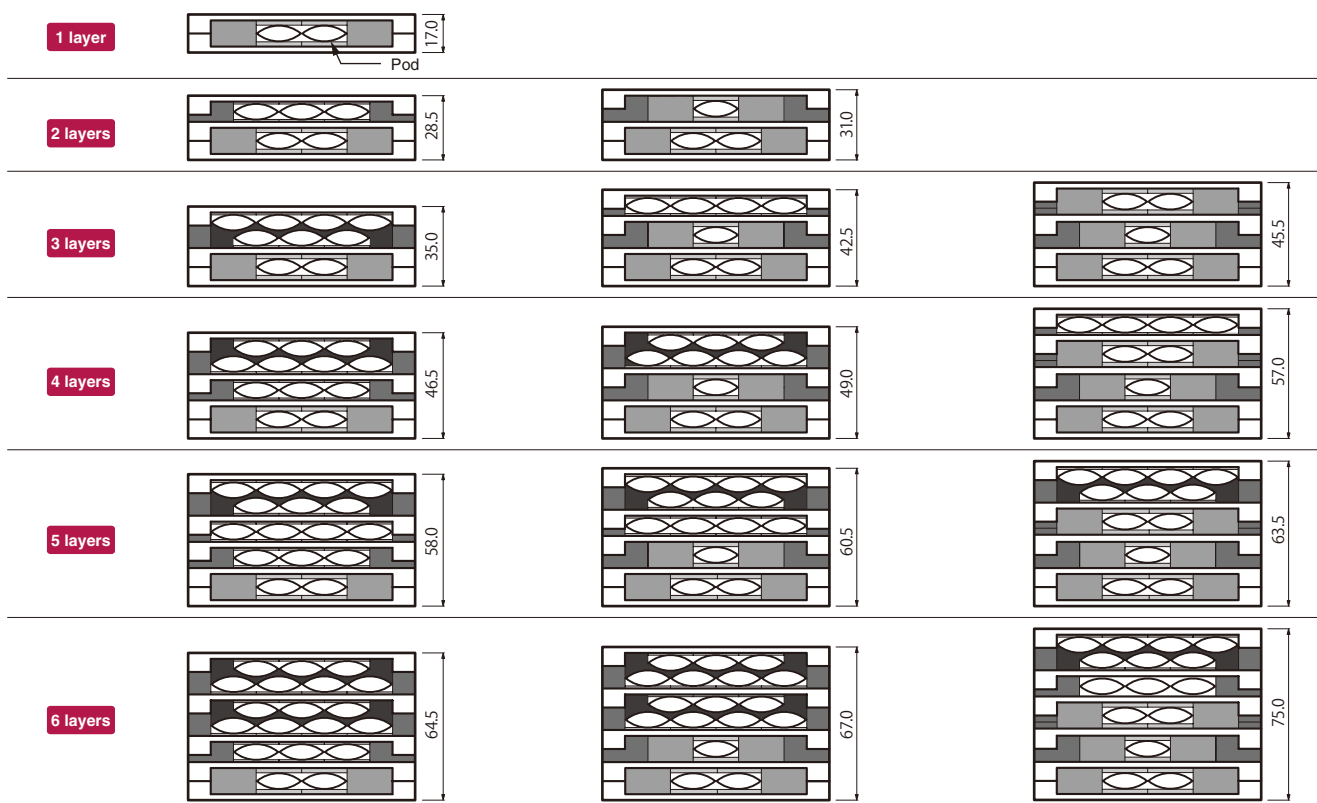

CLEANVEYOR products are all made to order. Write the operating conditions on the inquiry sheet (page 33) and send it to a Tsubaki representative. Tsubaki will select the types.

## Layering examples

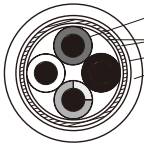
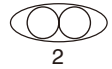
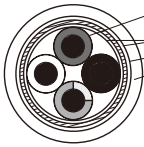
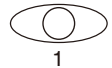
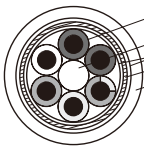
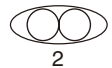
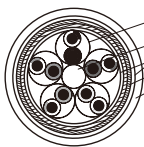
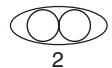
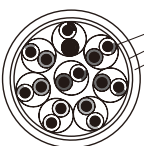
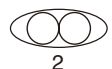
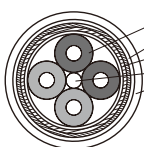
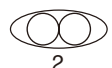
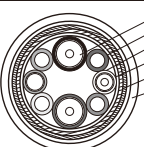

# CLEANVEYOR

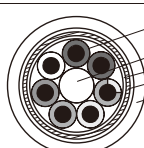
## Cable

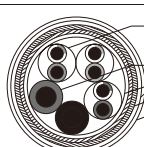
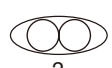
No.	Certification status		Rated voltage (V)	Rated temperature (°C)	Cross section	Specifications	Configuration		Outer diameter (mm)	Installable No. of cables
	UL	CE					Conductor	Insulator		
C2		○				HCM-41073/4 4x18AWG w/shield Servomotor power supply	Conductor Insulator Binder tape Sheath	Annealed copper wire FEP ePTFE PVC LF	6.0	
C3		○				HCM-41072/4 4x16AWG w/shield Servomotor power supply	Conductor Insulator Binder tape Sheath	Annealed copper wire FEP ePTFE PVC LF	6.8	
C4		○				HCM-41074/6 6x20AWG w/shield Servomotor power supply	Conductor Insulator Binder tape Sheath	Annealed copper wire FEP ePTFE PVC LF	6.2	
C5	○	○	30	80		HCM-41426/10 5Px26AWG w/shield Servomotor encoder Signals and control	Conductor Insulator Binder tape Sheath	Tinned annealed copper wire ETFE ePTFE PVC LF	5.1	
C6	○	○	30	80		HCM-41410/16 8Px26AWG Signals I/O	Conductor Insulator Binder tape Sheath	Tinned annealed copper wire ETFE ePTFE PVC LF	5.1	
C8	○	○	30	80		HCM-41081/4 4x26AWG w/shield IEEE1394 Communications	Conductor Insulator Binder tape Sheath	Tinned annealed copper wire FEP ePTFE PVC LF	5.5	
C9			300	80		HCM-41224/8 2x30AWG (75-Ω coax) + 4x26AWG + 2x26AWG w/shield Collectively shielded Video or machine vision	Conductor Insulator Binder tape Jacket Sheath	Tinned annealed copper wire POLYOLEFIN/FEP FEP PTFE PVC LF	6.7	
C10	○	○	30	80		HCM-41414/7 7x22AWG w/shield Signals I/O	Conductor Insulator Binder tape Sheath	Tinned annealed copper wire FEP ePTFE PVC LF	6.6	
C11	○	○	30	80		HCM-41877/8 2x22AWG+ 3Px26AWG w/shield control	Conductor Insulator Binder tape sheath	Tinned annealed copper wire ETFE/FEP ePTFE PVC LF	5.8	

Notes: 1. Contact a Tsubaki representative for further information on using cables not listed here.  
2. When supplying a cable with a connector. Supply one end without a connector.

**Tubes**

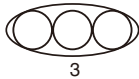
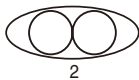
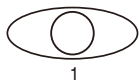
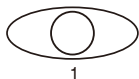
No.	Specifications			Configuration		Installable No. of cables
	Outer diameter (mm)	Inner diameter (mm)	Maximum working pressure (MPa)	Materials	Color	
A1	4.0	2.5	0.8 (20°C)	Polyurethane	Black, yellow, blue, green, transparent, and white	 3
A2	6.0	4.0	0.8 (20°C)	Polyurethane	Black, yellow, blue, green, transparent, and white	 2
A3	8.0	5.0	0.8 (20°C)	Polyurethane	Black, yellow, blue, green, transparent, and white	 1
A4	10.0	6.5	0.8 (20°C)	Polyurethane	Black, yellow, blue, green, transparent, and white	 1

Note: Contact a Tsubaki representative for further information on using tubes not listed here.

# CLEANVEYOR

## Installation steps

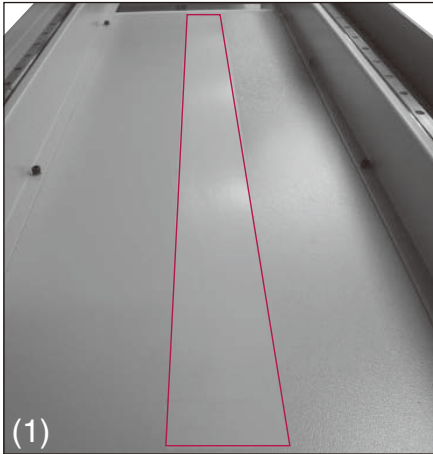

(1) Attach an ultra-high molecular weight polyethylene sheet to the floor where the CLEANVEYOR will be installed.

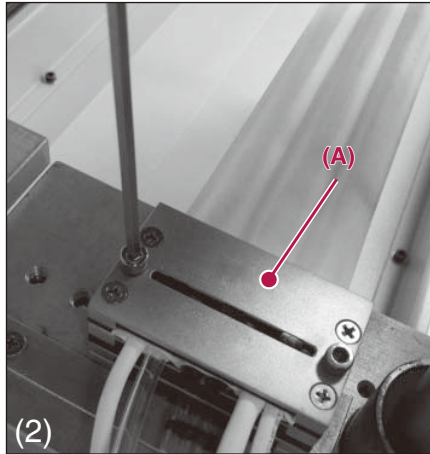

(2) Temporarily tighten the moving end clamp (A).

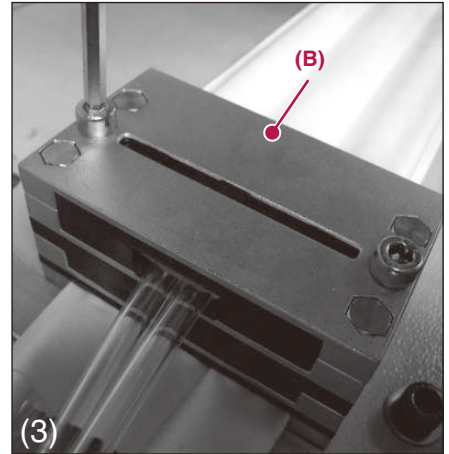

(3) Temporarily tighten the fixed end clamp (B).

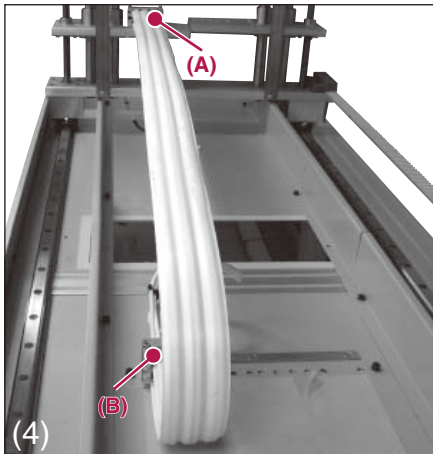

(4) With the moving (A) and fixed end clamps (B) temporarily tightened, run the moving end one cycle to check operation.

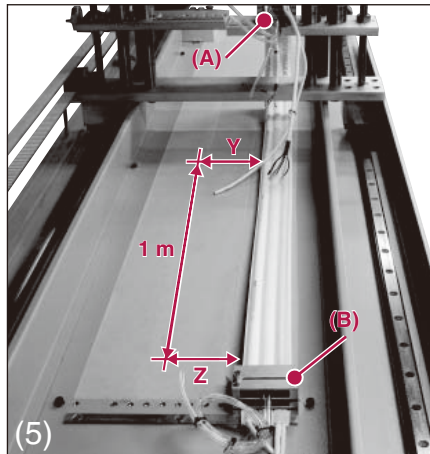

(5) Adjust the amount of lateral deviation in moving direction as follows.  
 1. Push the moving end clamp (A) by hand all the way back.  
 2. Check if the difference between Z dimension and Y dimension is within  $\pm 10$  mm per 1 m.  
 3. If it is within  $\pm 10$  mm, securely fix the fixed end clamp (B)\*1.  
 Note: ★1. If there is a difference exceeding  $\pm 10$  mm, adjust the position of the fixed end clamp (B) to fix it within  $\pm 10$  mm.

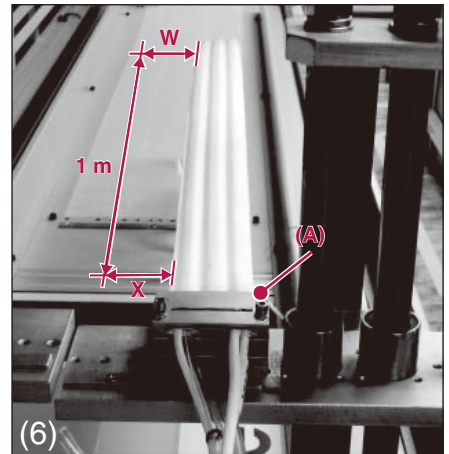

(6) Adjust the amount of lateral deviation in moving direction as follows.  
 1. Move the moving end clamp (A) to the position with the longest unsupported length.  
 2. Check if the difference between the X dimension and the W dimension is within  $\pm 10$  mm per 1 m.  
 3. If it is within  $\pm 10$  mm, securely fix the moving end clamp (A).  
 Note: ★1. If there is a difference exceeding  $\pm 10$  mm, adjust the position of the moving end clamp (A) to fix it within  $\pm 10$  mm.

### Operating precautions

- Remove any debris on the installation surface, and allow the CLEANVEYOR to slide on top of the included ultra-high molecular weight polyethylene sheet.
- Do not expose the product to organic solvents that will affect it.
- The moving end of cables and hoses is the end with the yellow label.

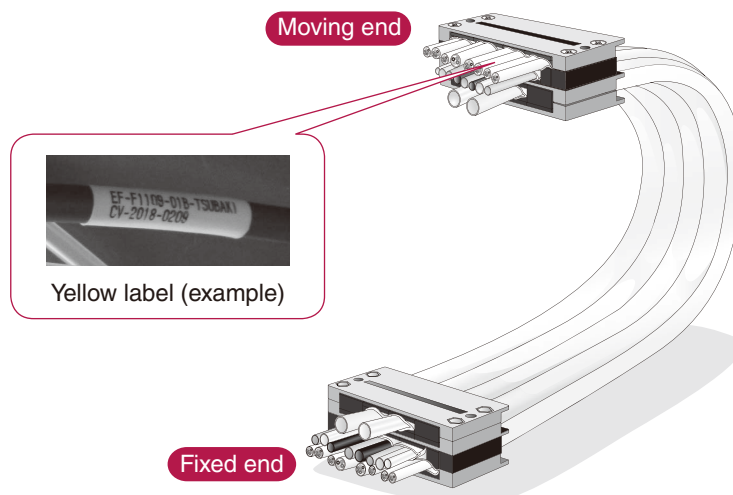

## Structure

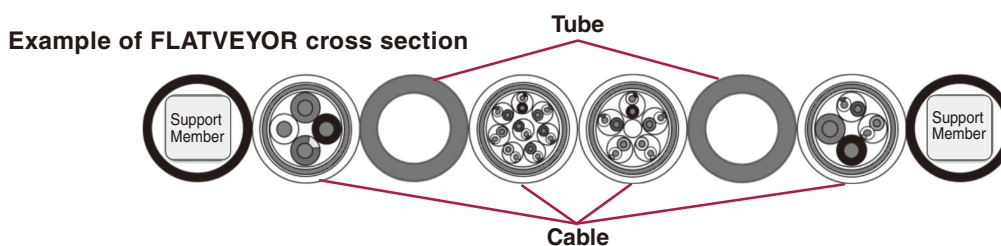
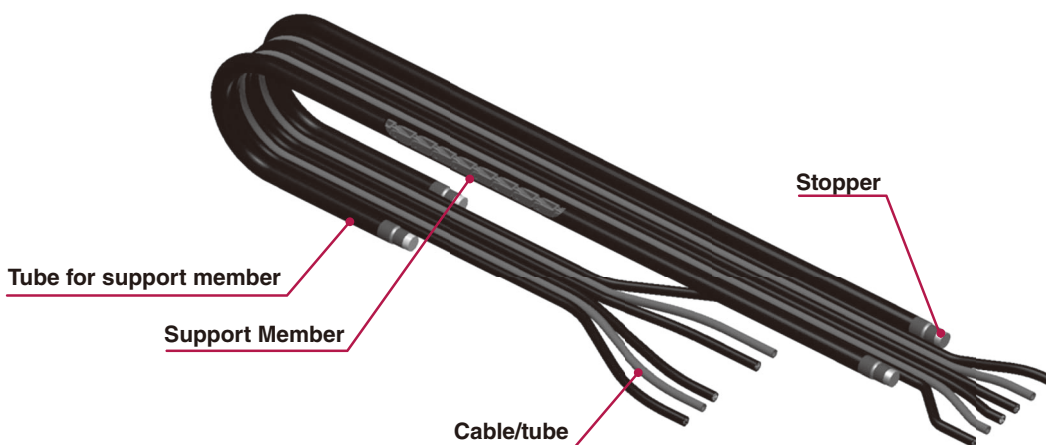

## Basic specifications/capacities

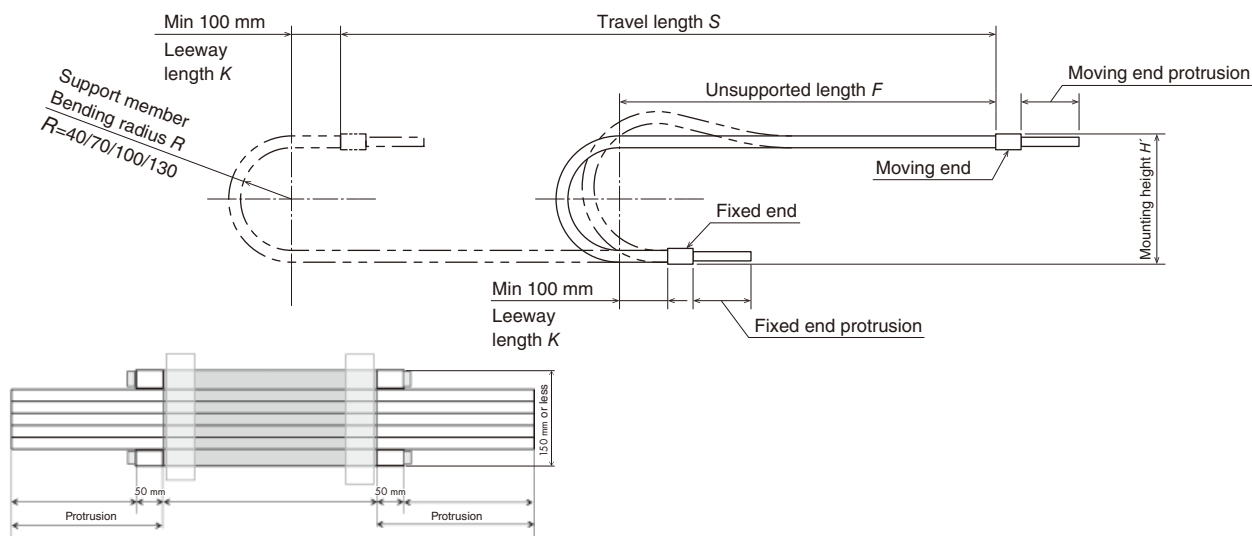

Maximum travel length * (mm)	Support member Bending radius R40.....1600 Support member Bending radius R70.....2200 Support member Bending radius R100....2800 Support member Bending radius R130....2800	
Maximum travel speed (m/sec)	2	
Maximum acceleration (G)	4	
Operating temperature range (°C)	-10 to 80	
Maximum cable/tube outer diameter (mm)	16 or less	
Estimated maximum width (mm)	150 or less (see diagram above)	
Materials	Support Member	Engineering plastic
	Tube for support member	PVC
	Stopper	P E

Support member Bending radius R	Mounting height H' (mm)
40	103 to 123
70	213 to 233
100	273 to 293
130	333 to 353

Notes: 1. When additional load is 0.4 kg/m.  
2. Support member-Bending radius and bending radius when installing the FLATVEYOR may differ.

# FLATVEYOR

## Selection

FLATVEYOR products are all made to order. Write the operating conditions on the inquiry sheet (page 33) and send it to a Tsubaki representative. Tsubaki will select the types.

### ■ Precautions regarding cable and tube bonding

#### ◆ Materials

Only cables with outer jackets made of PVC or polyurethane, or tubes made of the same, can be bonded. Contact a Tsubaki representative to use materials other than those listed above.

#### ◆ Differences in outer diameters

The ideal permissible difference between the outer diameters of adjacent cables and tubes should be less than approximately 30%. If there is an outer diameter difference that exceeds that, we may suggest using dummy tubes.

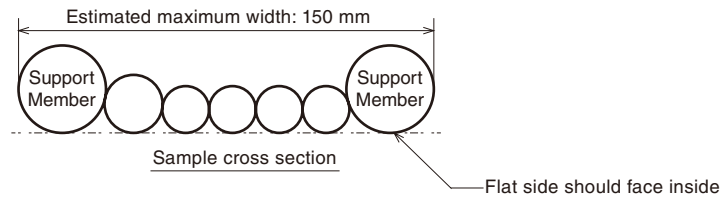

## Option

### ■ Connector installation

If you provide us with the name of a specific connector manufacturer, the connector model number, the terminal number, and connection information, Tsubaki will confirm its usability for you.

The parts used can be either procured or supplied by us.

### ■ Installing cables not listed in this catalog

Installing is possible cables not listed our catalog. Contact a Tsubaki representative.

Our warranty is not applicable on cables supplied by a customer except for defects caused by the manufacture of FLATVEYOR.

### ■ Clamp

Tsubaki can also manufacture clamps. If you will manufacture your own clamps, please follow the recommended dimensions below.

## Handling FLATVEYOR attachment clamps

### ■ Cable diameter 8.5 mm or less

Ensure that the clamp length is 50 mm or greater and the clamp thickness is 3 mm or greater, and adjust the clamp inner heights between 8.5 mm and 9.0 mm. Fasten the clamp with M6 bolts in four locations.

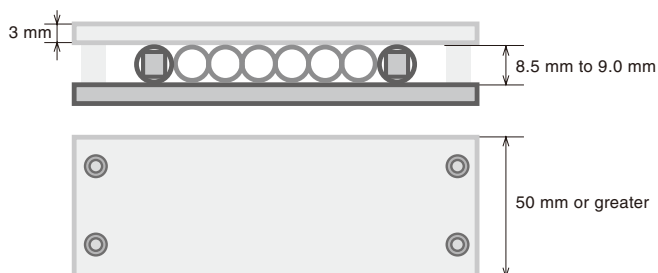

### ■ Cable diameter greater than 8.5 mm

Ensure that the clamp length is 50 mm or greater and the clamp thickness is 3 mm or greater, and adjust inner heights between 8.5 mm and 9.0 mm at the tube for support member with spacers. Fasten the clamp with M6 bolts in four locations.

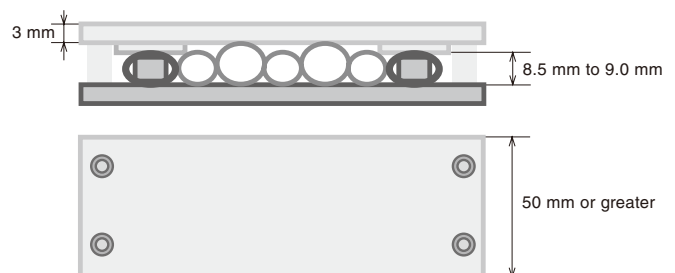

### ■ Precautions

Be advised that the support member will deform and may break if the height of the tube for support member section is less than 8.5 mm.

## Installation steps

When installing the FLATVEYOR on the equipment, **install the attachment clamps in the positions shown on the Tsubaki product drawing.**

1. **Bend the FLATVEYOR** (1) before fastening it to the equipment.

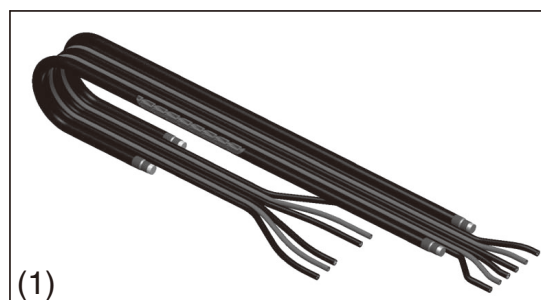

2. **While in the state shown in (1)**, fasten the moving end and fixed end to the equipment with the attachment clamps. (2)

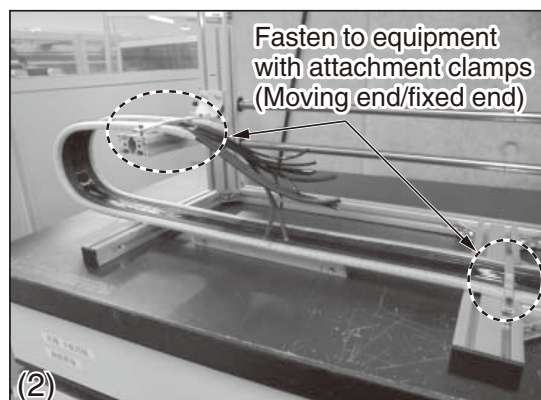

3. After fastening the moving end and fixed end, **confirm that the bent section of the FLATVEYOR is not skewed and that the unsupported length section is not twisted.** (3)  
Next, move the FLATVEYOR slowly and confirm there are no problems with its operation.

- × Inclination of bending part
- × Twist of unsupported length

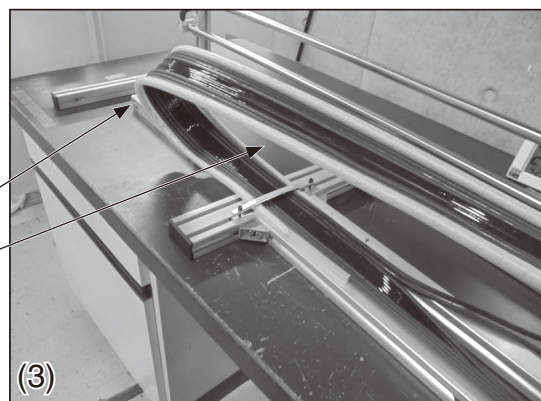

## Installation precautions

Do not fasten one end of the FLATVEYOR when it is straighten.  
If one end (moving end or fixed end) of the FLATVEYOR is fastened to the equipment while the FLATVEYOR is straighten, and then the FLATVEYOR is bent, **the support members may twist and break.**

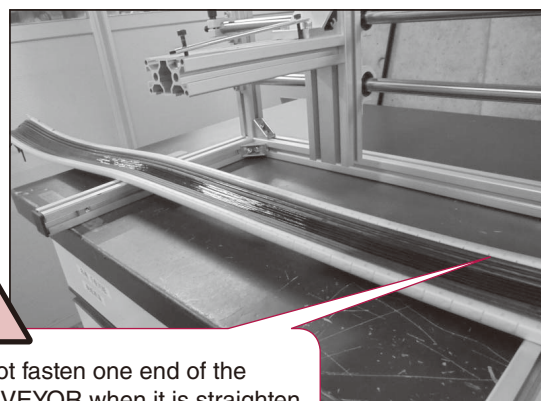

# FLATVEYOR

## 600-V rated cables

UL STYLE No.	2586
Rated temperature (°C)	105
Rated voltage (V)	600
Operating temperature range (°C)	-10 to 105

Conductor	Tinned annealed and stranded copper wire
Insulator	Special elastomer
Shield	Tinned annealed copper wire braid
Sheath	Oil resistant PVC (black)

With/without shield	Minimum bending radius
Unshielded	6-times cable outer diameter or greater
Shielded	8-times cable outer diameter or greater

Conductor			Core diameter (mm)	Cores	Unshielded					Shielded					Permissible current * A (30°C)
SQ (mm <sup>2</sup> )	AWG size	Configuration			No.	Outer diameter (mm)	Approximate mass (kg/km)	Approximate mass (kg/m)	Minimum bending R Outer diameter x 6	No.	Outer diameter (mm)	Approximate mass (kg/km)	Approximate mass (kg/m)	Minimum bending R Outer diameter x 8	
0.5	21	100/0.08	1.52	2	P1	5.3	34	0.034	32	P35	5.7	45	0.045	46	9.2
				3	P2	5.5	41	0.041	33	P36	5.9	53	0.053	48	8.0
				4	P3	5.9	49	0.049	36	P37	6.3	61	0.061	51	7.2
				5	P4	6.3	58	0.058	38	P38	6.7	72	0.072	54	6.7
				6	P5	6.8	66	0.066	41	P39	7.2	83	0.083	58	6.2
				8	P6	8.0	90	0.090	48	P40	8.4	110	0.110	68	5.6
				10	P7	8.9	110	0.110	54						
0.75	19	150/0.08	1.73	2	P8	5.7	41	0.041	35	P41	6.1	53	0.053	49	12.0
				3	P9	5.9	51	0.051	36	P42	6.3	62	0.062	51	10.5
				4	P10	6.4	63	0.063	39	P43	6.8	75	0.075	55	9.4
				6	P11	7.4	87	0.087	45	P44	7.8	105	0.105	63	8.1
				8	P12	8.8	120	0.120	53	P45	9.3	145	0.145	75	7.3
1.25	17	7/36/0.08	2.2	2	P14	6.6	58	0.058	40	P46	7.0	72	0.072	56	17.3
				3	P15	7.0	75	0.075	42	P47	7.4	89	0.089	60	15.1
				4	P16	7.5	92	0.092	45	P48	7.9	110	0.110	64	13.5
				6	P17	8.8	130	0.130	53	P49	9.3	155	0.155	75	11.7
				8	P18	10.5	180	0.180	63	P50	11.1	210	0.210	89	10.6
2	15	7/57/0.08	2.6	2	P20	7.4	79	0.079	45	P51	7.8	94	0.094	63	23.6
				3	P21	7.8	105	0.105	47	P52	8.2	120	0.120	66	20.6
				4	P22	8.5	130	0.130	51	P53	9.0	155	0.155	72	18.4
				6	P23	10.0	185	0.185	60	P54	10.5	220	0.220	84	15.9
				8	P24	12.0	250	0.250	72	P55	12.5	290	0.290	100	14.4
3.5	12	7/64/0.1	3.4	2	P26	9.3	125	0.125	56	P56	9.8	155	0.155	79	35.5
				3	P27	9.8	165	0.165	59	P57	10.3	195	0.195	83	30.9
				4	P28	10.7	210	0.210	65	P58	11.2	240	0.240	90	27.6
				6	P29	12.9	290	0.290	78	P59	13.4	330	0.330	108	23.9
				8	P30	15.5	430	0.430	93	P60	16.0	470	0.470	128	21.6
5.5	10	7/100/0.1	4.15	2	P31	11.2	190	0.190	68	P61	11.7	220	0.220	94	48.7
				3	P32	11.8	250	0.250	71	P62	12.3	280	0.280	99	42.4
				4	P33	12.9	290	0.290	78	P63	13.4	320	0.320	108	38.0
				6	P34	15.5	470	0.470	93	P64	16.0	510	0.510	128	32.9

\*: Permissible current is for reference and not a guaranteed value.

### Sample cross section

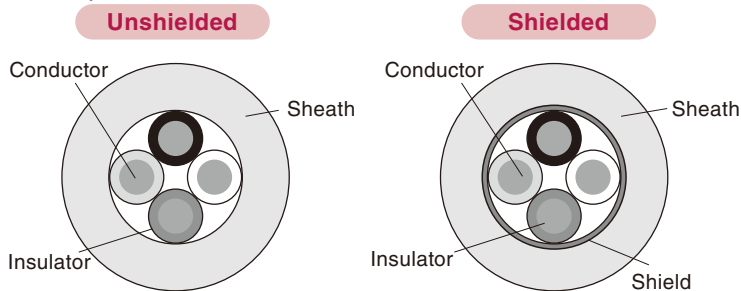

### Identification of insulators

Core No.	Color
1	Black
2	White
3	Red
4	Green
5	Yellow
6	Brown
7	Blue
8	Gray
9	Orange
10	Purple



**300-V rated cables**

UL STYLE No.	2464
Rated temperature (°C)	80
Rated voltage (V)	300
Operating temperature range (°C)	-10 to 80

Conductor	Tinned annealed and stranded copper wire
Insulator	Special elastomer
Shield	Tinned annealed copper wire braid
Sheath	Oil resistant PVC (black)

With/without shield	Minimum bending radius
Unshielded	6-times cable outer diameter or greater
Shielded	8-times cable outer diameter or greater

Conductor			Core diameter (mm)	Pairs	Unshielded					Shielded					Permissible current * A (30°C)
SQ (mm <sup>2</sup> )	AWG size	Configuration			No.	Outer diameter (mm)	Approximate mass (kg/km)	Approximate mass (kg/m)	Minimum bending R Outer diameter x 6	No.	Outer diameter (mm)	Approximate mass (kg/km)	Approximate mass (kg/m)	Minimum bending R Outer diameter x 8	
0.1	28	49/0.05	0.74	1	S1	3.3	13	0.013	20	S32	3.8	21	0.021	31	2.4
				2	S2	4.4	20	0.020	27	S33	4.8	30	0.030	39	1.8
				3	S3	4.7	23	0.023	29	S34	5.1	34	0.034	41	1.6
				4	S4	5.0	27	0.027	30	S35	5.4	38	0.038	44	1.4
				5	S5	5.3	32	0.032	32	S36	5.7	43	0.043	46	1.3
				6	S6	5.6	36	0.036	34	S37	6.0	48	0.048	48	1.2
				7	S7	5.6	39	0.039	34	S38	6.0	50	0.050	48	1.2
				8	S8	6.0	43	0.043	36	S39	6.4	56	0.056	52	1.1
				9	S9	6.6	52	0.052	40	S40	7.0	66	0.066	56	1.0
				10	S10	3.7	17	0.017	23	S41	4.2	25	0.025	34	3.8
0.2	25	102/0.05	0.93	2	S11	5.0	27	0.027	30	S42	5.4	37	0.037	44	3.0
				3	S12	5.3	34	0.034	32	S43	5.7	45	0.045	46	2.6
				4	S13	5.7	39	0.039	35	S44	6.3	51	0.051	51	2.3
				5	S14	6.1	47	0.047	37	S45	6.5	60	0.060	52	2.1
				6	S15	6.6	54	0.054	40	S46	7.1	69	0.069	57	2.0
				7	S16	6.6	58	0.058	40	S47	7.1	73	0.073	57	1.9
				8	S17	7.1	65	0.065	43	S48	7.6	80	0.080	61	1.8
				9	S18	7.8	80	0.080	47	S49	8.2	97	0.097	66	1.7
				1	S19	4.0	20	0.020	24	S50	4.4	28	0.028	36	5.2
				0.3	23	108/0.06	1.09	2	S20	5.5	36	0.036	33	S51	5.9
3	S21	5.9	42					0.042	36	S52	6.4	54	0.054	52	3.5
4	S22	6.3	51					0.051	38	S53	6.7	64	0.064	54	3.2
5	S23	6.9	61					0.061	42	S54	7.3	76	0.076	59	2.9
6	S24	7.4	72					0.072	45	S55	7.8	87	0.087	63	2.7
7	S25	7.4	78					0.078	45	S56	7.8	94	0.094	63	2.5
8	S26	8.0	88					0.088	48	S57	8.4	105	0.105	68	2.4
9	S27	8.8	110					0.110	53	S58	9.2	130	0.130	74	2.3
1	S28	4.6	26					0.026	28	S59	5.0	37	0.037	30	7.7
0.5	21	177/0.06	1.36					2	S29	6.4	51	0.051	39	S60	6.8
				3	S30	6.9	64	0.064	42	S61	7.3	82	0.082	44	4.9
				4	S31	7.5	75	0.075	45	S62	7.9	94	0.094	48	4.7

\*: Permissible current is for reference and not a guaranteed value.

■ Sample cross section

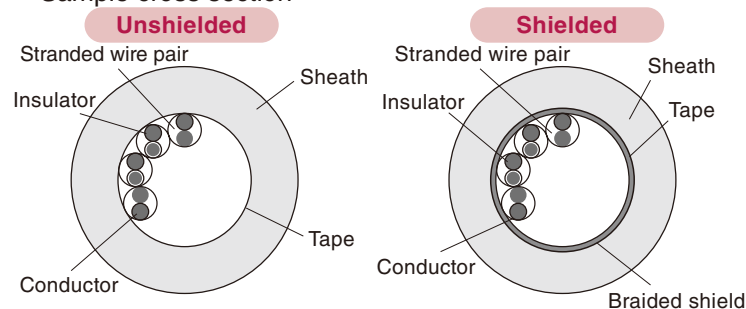

■ Identification of insulators

Pair No.	Color		Pair No.	Color	
	Core 1	Core 2		Core 1	Core 2
1	Blue	White	6	Blue	Brown
2	Yellow	Purple	7	Yellow	Black
3	Green	Black	8	Green	Gray
4	Red	Gray	9	Red	Orange
5	Purple	Orange	10	Purple	White

**Tubes**

No.	Specifications			Configuration	
	Outer diameter (mm)	Inner diameter (mm)	Maximum working pressure (MPa)	Materials	Color
A1	4.0	2.5	0.8 (20°C)	Polyurethane	Black, Yellow, Blue, Green, Transparent, White
A2	6.0	4.0	0.8 (20°C)	Polyurethane	Black, Yellow, Blue, Green, Transparent, White
A3	8.0	5.0	0.8 (20°C)	Polyurethane	Black, Yellow, Blue, Green, Transparent, White
A4	10.0	6.5	0.8 (20°C)	Polyurethane	Black, Yellow, Blue, Green, Transparent, White

# CLEANVEYOR and FLATVEYOR Inquiry Sheet

## Product name

- CLEANVEYOR     FLATVEYOR

## Installation method

- Standard arrangement     Vertical arrangement (standing)     Vertical arrangement (hanging)     Top-fixed arrangement (bottom movement)



Note: Contact a Tsubaki representative regarding a side mount arrangement or nested arrangement.

## Specifications and conditions

- Maximum travel length: S (required)  
Write the distribution of the length when the front/back length is not S/2.  
\_\_\_\_\_ mm  
S<sub>1</sub>: \_\_\_\_\_ mm    S<sub>2</sub>: \_\_\_\_\_ mm
  - Allowable mounting height (required) \_\_\_\_\_ mm
  - Allowable mounting width (required) \_\_\_\_\_ mm
- If the mounting height or width does not satisfy the specifications and conditions, select the value to use as the standard.

Mounting height     Mounting width
- Maximum acceleration (required) \_\_\_\_\_ m/s<sup>2</sup>
  - Travel speed (required) \_\_\_\_\_ m/s
  - Machine to be used \_\_\_\_\_
  - Operating environment    Temperature \_\_\_\_\_ °C    Humidity \_\_\_\_\_ %
  - Frequency of use \_\_\_\_\_ times/day
  - Special remarks

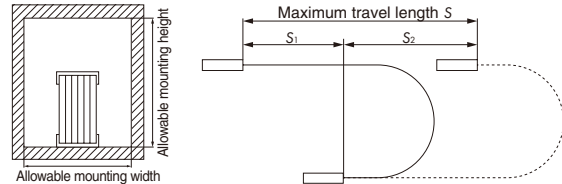

## Cables and tubes to be used

The items in the following tables are all required.

■ Cables (For CLEANVEYOR, cables can install a connector on one end or no connectors only. Cables cannot be installed when cables have connectors on both ends.)

No. *1	Rated voltage (V)	Rated temperature (°C)	No. of cores C or no. of pairs P	Conductor size AWG or SQ	Shield With ○/without ×	Outer diameter (mm)	Mass (kg/m)	Minimum bending radius (mm)	No. of cables	Fixed end protrusion (mm)	Moving end protrusion (mm)	Provided Yes ○/No ×	Connector *2 With ○/without ×	
													Fixed end	Moving end
	300	80	4C	20AWG	○	5.0	0.01	40	1	1000	500	○	×	×
P11									2	1000	500		×	×

■ Tubes

No. *1	Color *3	Outer diameter (mm)	Inner diameter (mm)	Mass (kg/m)	Minimum bending radius (mm)	No. of tubes	Fixed end protrusion (mm)	Moving end protrusion (mm)	Provided Yes ○/No ×
A2	Blue	6.0	4.0	0.0193	15	1	1000	500	×

\*1. Select the desired cable numbers and tubes numbers from pages 25 to 26 for a CLEANVEYOR and pages 31 to 32 for a FLATVEYOR.  
 \*2. Include a harness drawing if connector fabrication is required.  
 \*3. The color will be black unless otherwise specified.

Company name \_\_\_\_\_ Department \_\_\_\_\_  
 Name \_\_\_\_\_ TEL \_\_\_\_\_  
 Date of submission \_\_\_\_\_ E-MAIL \_\_\_\_\_

# Cable Carrier Plastic Series

## Open type

### TKP Series

TKP13H10 Openable Stay (W6, W15).....	35
TKP13H10 Openable Stay (W10, W20).....	36
TKP13H10 Single-part Frame (W6, W10, W15, W20) .....	37
TKP17H11.....	38
TKP18H14 Openable Stay (W15, W40).....	39
TKP18H15 Openable Stay (W20, W30).....	40
TKP18H15 Single-part Frame (W15, W20, W30, W40) .....	41
TKP25H15 .....	43
TKP35H22.....	45
TKP35H32.....	47
TKP45H25.....	49
TKP58H39.....	51
TKP62H34.....	53
TKP68H46.....	55
TKP90H50.....	57
TKP91H56.....	59
TKP91H80.....	61
TKP125H74 .....	63

### TKP Series MW Type (Low Friction/Anti-Wear Series)

TKP Series MW Type (Low Friction/Anti-Wear Series).....	65
---	----

### TKR Series

TKR15H22.....	67
TKR20H28.....	69
TKR26H40.....	71
TKR28H52.....	73
TKR37H28.....	75

### TKZP Series

TKZP10H13.....	77
----------------	----

# TKP13H10 Openable Stay (W6, W15)

## Structure

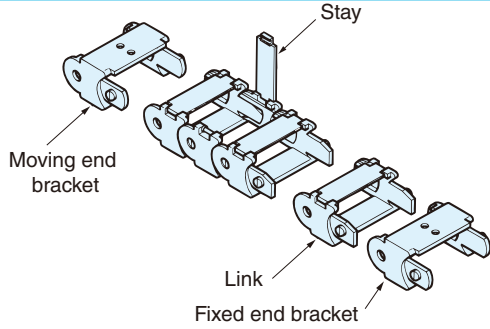

## Cross-section dimensions

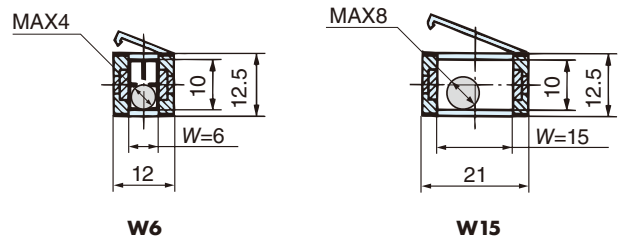

A-A arrow view

## Dimensions & brackets

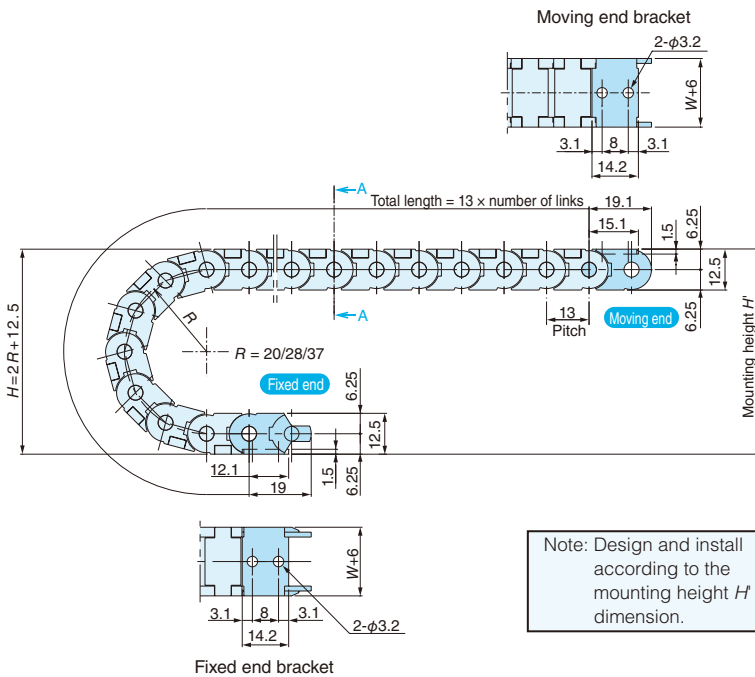

Note: Design and install according to the mounting height  $H'$  dimension.

Bending radius R (mm)	Mounting height $H'$ (mm)
20	62.5 to 82.5
28	78.5 to 98.5
37	96.5 to 116.5

Note: MO, MI, FO, and FI brackets are all common parts.

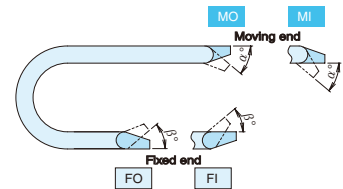

Bending radius R (mm)	Bending angle (°)	
	Moving end side ( $\alpha$ )	Fixed end side ( $\beta$ )
Common for all R	0	0

## Basic specifications

Maximum travel speed (m/min)	300 *1	
Operating temperature range (°C)	-40 to 80	
Materials	Link	Engineering plastic (black)
	Bracket	
Standard length (No. of links)	77	

Notes: \*1. 150 m/min for support roller arrangement.  
2. Cannot be used in acidic or alkaline environments.

## Load diagram

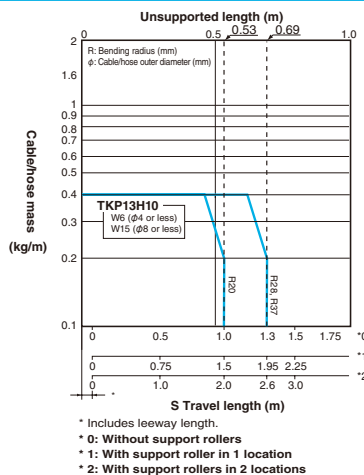

## Calculating no. of links

$$\text{Number of links} = \frac{S}{2} + \frac{\pi R}{P} + 2K$$

Note: When fixed end is at the center of the travel length. Always round up the value after calculating.

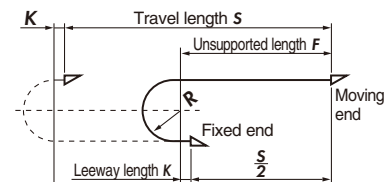

**S:** Travel length (mm)  
**R:** Bending radius (mm)  
**P:** Pitch = 13 mm  
**K:** Leeway length = 13 mm or greater

## Model number

**TKP13H10 - (1) W (2) R (3) + (4) L - (5) - (6)**

(1) Opening options	(2) Inner width	(3) Bending radius	(4) Number of links	(5) Fixed end	(6) Moving end
30	6	20		FO	MO
Outside openable stay	15	28		FI	MI
		37			

Note: Brackets are delivered uninstalled.

# TKP13H10 Openable Stay (W10, W20)

## Structure

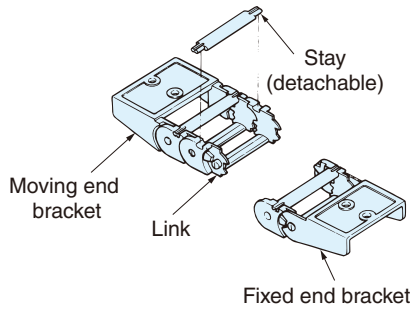

## Cross-section dimensions

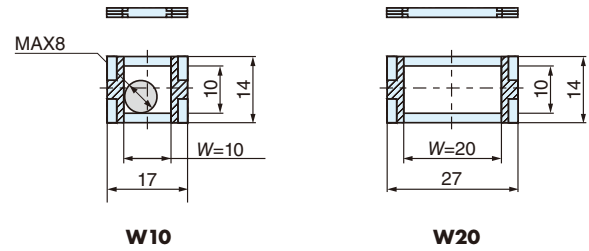

A-A arrow view

## Dimensions & brackets

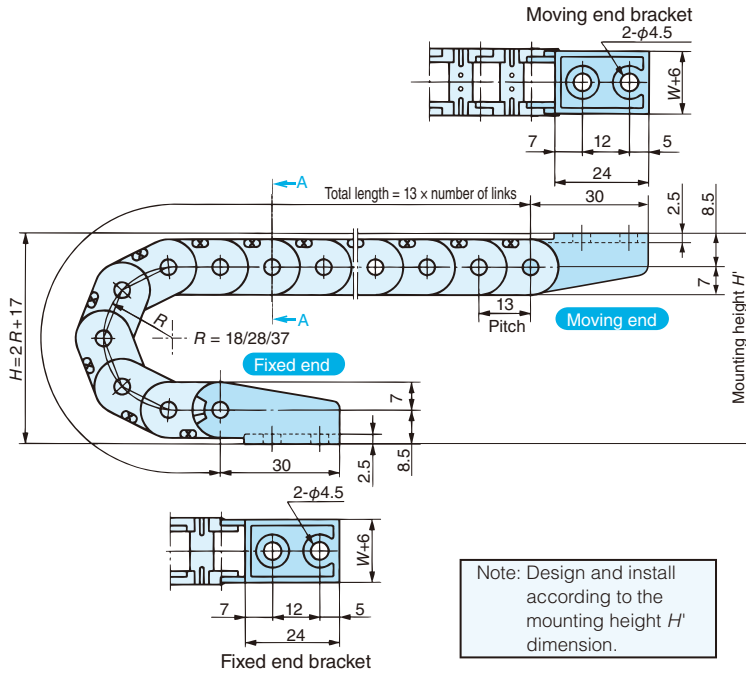

Bending radius R (mm)	Mounting height H' (mm)
18	63 to 83
28	83 to 103
37	101 to 121

Notes: 1. MO and MI brackets and FO and FI brackets are each common parts.  
2. Stays are delivered uninstalled.

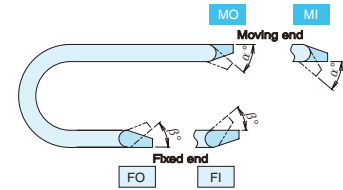

Bending radius R (mm)	Bending angle (°)	
	Moving end side (α)	Fixed end side (β)
18	45	42
28		26
37		20

## Basic specifications

Maximum travel speed (m/min)	300 *1	
Operating temperature range (°C)	-40 to 80	
Materials	Link	Engineering plastic
	Bracket	(black)
Standard length (No. of links)	77	

Notes: ★ 1. 150 m/min for support roller arrangement.  
2. Cannot be used in acidic or alkaline environments.

## Load diagram

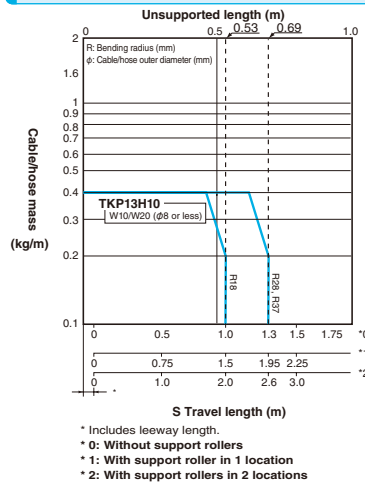

## Calculating no. of links

$$\text{Number of links} = \frac{S}{2} + \frac{\pi R}{P} + 2K$$

Note: When fixed end is at the center of the travel length. Always round up the value after calculating.

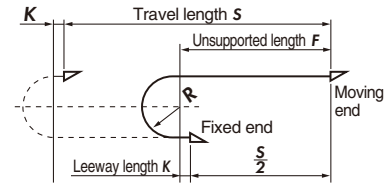

S: Travel length (mm)  
R: Bending radius (mm)  
P: Pitch = 13 mm  
K: Leeway length = 13 mm or greater

## Model number

TKP13H10 - (1) W (2) R (3) TC + (4) L - (5) - (6)

(1) Opening options	(2) Inner width	(3) Bending radius	(4) Number of links	(5) Fixed end	(6) Moving end
30 Outside openable stay	10	18		FO	MO
	20	28		FI	MI
		37			

Note: Stays and brackets are delivered uninstalled.

# TKP13H10 Single-part Frame (W6, W10, W15, W20)

## Structure

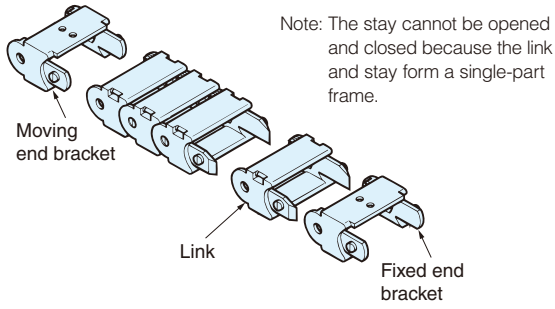

## Cross-section dimensions

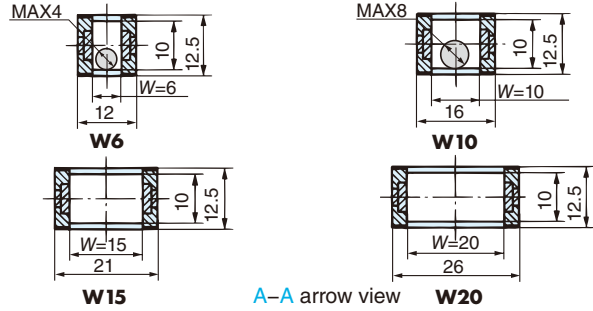

## Dimensions & brackets

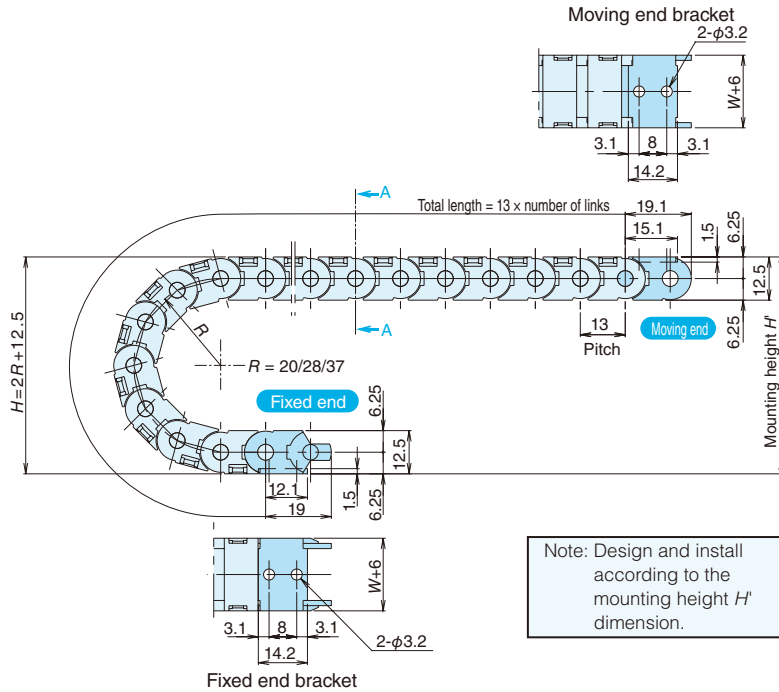

Bending radius R (mm)	Mounting height H' (mm)
20	62.5 to 82.5
28	78.5 to 98.5
37	96.5 to 116.5

Note: MO, MI, FO, and FI brackets are all common parts.

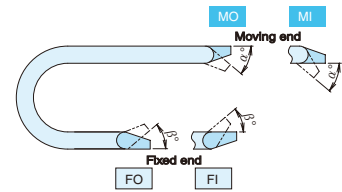

Bending radius R (mm)	Bending angle (°)	
	Moving end side (α)	Fixed end side (β)
Common for all R	0	0

## Basic specifications

Maximum travel speed (m/min)	300 *1	
Operating temperature range (°C)	-40 to 80	
Materials	Link	Engineering plastic (black)
	Bracket	
Standard length (No. of links)	77	

Notes: ★1. 150 m/min for support roller arrangement.  
2. Cannot be used in acidic or alkaline environments.

## Load diagram

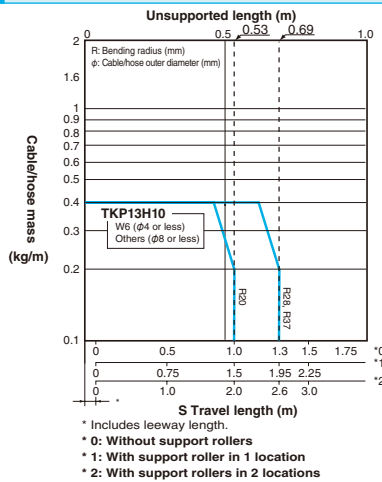

## Calculating no. of links

$$\text{Number of links} = \frac{S}{2} + \frac{\pi R}{P} + \frac{2K}{P}$$

Note: When fixed end is at the center of the travel length. Always round up the value after calculating.

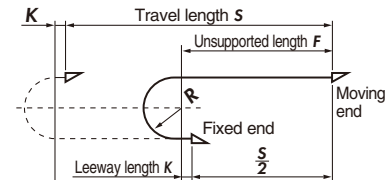

S: Travel length (mm)  
R: Bending radius (mm)  
P: Pitch = 13 mm  
K: Leeway length = 13 mm or greater

## Model number

TKP13H10 - (1) W (2) R (3) + (4) L - (5) - (6)

(1) Opening options	(2) Inner width	(3) Bending radius	(4) Number of links	(5) Fixed end	(6) Moving end
20 Single-part frame (stay cannot be opened)	6	20		FO	MO
	10	28		FI	MI
	15	37			
	20				

Note: Brackets are delivered uninstalled.

## Structure

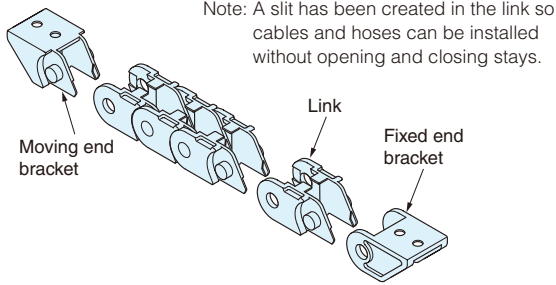

## Cross-section dimensions

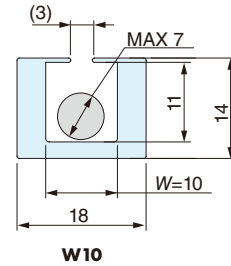

A-A arrow view

## Dimensions & brackets

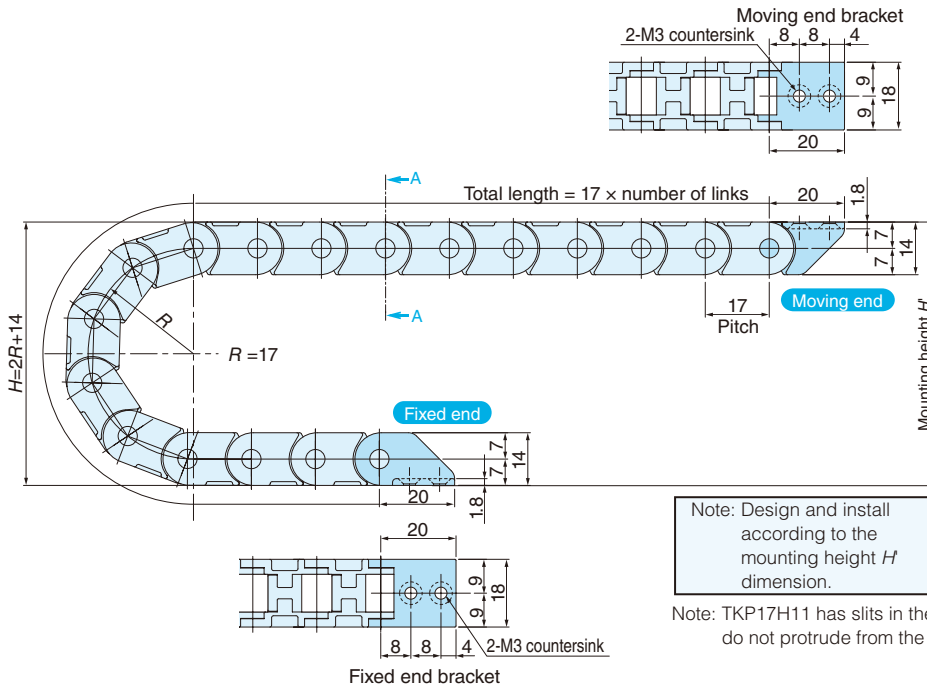

Bending radius R (mm)	Mounting height H' (mm)
17	58 to 78

Note: FO and FI brackets are common parts.

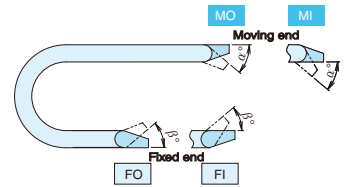

Bending radius R (mm)	Bending angle (°)	
	Moving end side (α)	Fixed end side (β)
17	60	55

Note: Design and install according to the mounting height H' dimension.

Note: TKP17H11 has slits in the links. Use flexible cables and hoses so that they do not protrude from the slits.

## Basic specifications

Maximum travel speed (m/min)	150	
Operating temperature range (°C)	-40 to 80	
Materials	Link	Engineering plastic (black)
	Bracket	
Standard length (No. of links)	60	

Note: Cannot be used in acidic or alkaline environments.

## Load diagram

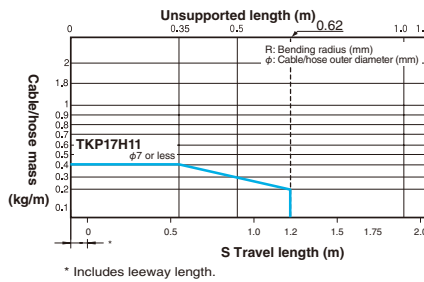

\* Includes leeway length.

## Calculating no. of links

$$\text{Number of links} = \frac{S}{2} + \frac{\pi R}{P} + \frac{2K}{P}$$

Note: When fixed end is at the center of the travel length. Always round up the value after calculating.

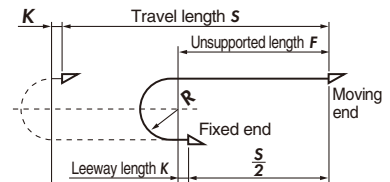

**S:** Travel length (mm)  
**R:** Bending radius (mm)  
**P:** Pitch = 17 mm  
**K:** Leeway length = 17 mm or greater

## Model number

TKP17H11 - (1) W (2) R (3) + (4) L - (5) - (6)

(1) Opening options	(2) Inner width	(3) Bending radius	(4) Number of links	(5) Fixed end	(6) Moving end
30 Outside openable stay	10	17		FO FI	MO MI

Note: Brackets are delivered uninstalled.

# TKP18H14 Openable Stay (W15, W40)

## Structure

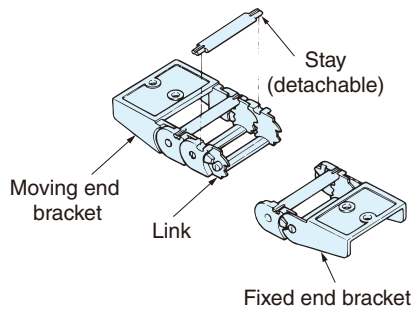

## Cross-section dimensions

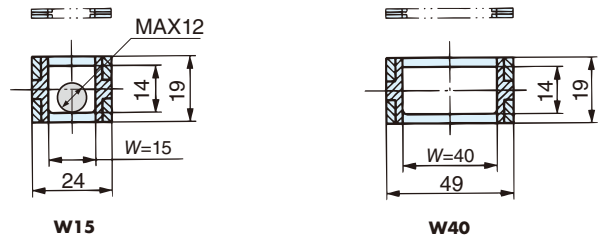

A-A arrow view

## Dimensions & brackets

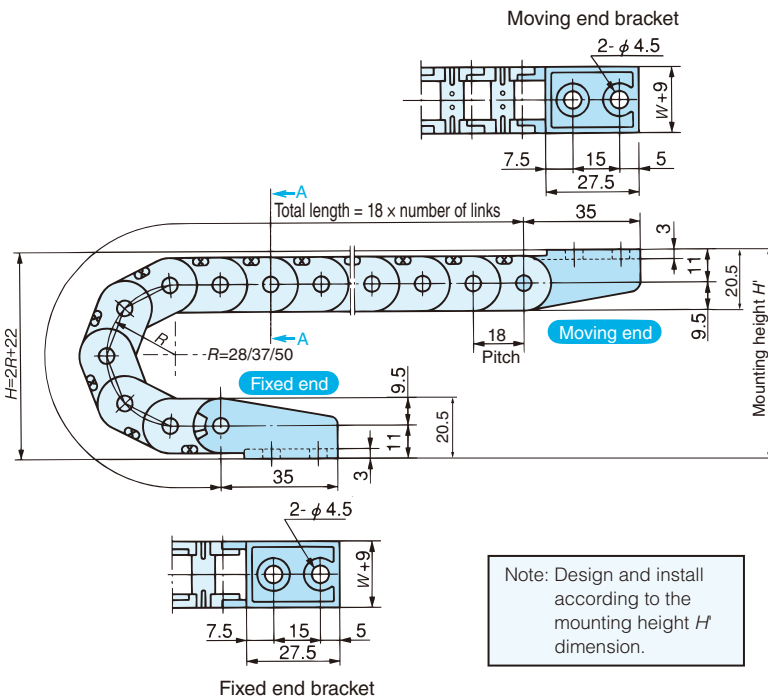

Note: Design and install according to the mounting height  $H'$  dimension.

Bending radius R (mm)	Mounting height H' (mm)
28	88 to 108
37	106 to 126
50	132 to 152

Notes: 1. MO and MI brackets and FO and FI brackets are each common parts.  
2. Stays are delivered uninstalled.

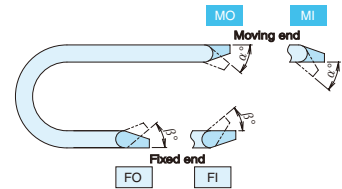

Bending radius R (mm)	Bending angle (°)	
	Moving end side ( $\alpha$ )	Fixed end side ( $\beta$ )
28	45	37
37		28
50		20

## Basic specifications

Maximum travel speed (m/min)	300 *1	
Operating temperature range (°C)	-40 to 80	
Materials	Link	Engineering plastic
	Bracket	(black)
Standard length (No. of links)	55	

Notes: \*1. 150 m/min for support roller arrangement.  
2. Cannot be used in acidic or alkaline environments.

## Load diagram

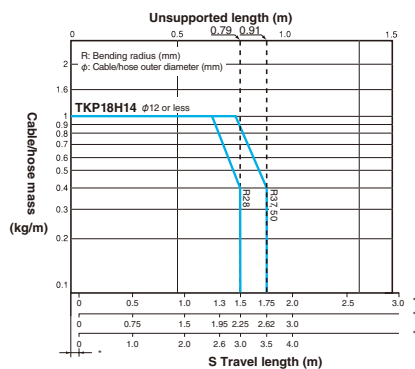

\* Includes leeway length.  
\* 0: Without support rollers  
\* 1: With support roller in 1 location  
\* 2: With support rollers in 2 locations

## Calculating no. of links

$$\text{Number of links} = \frac{S}{2} + \frac{\pi R}{P} + \frac{2K}{P}$$

Note: When fixed end is at the center of the travel length. Always round up the value after calculating.

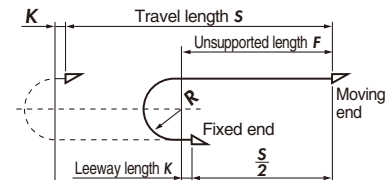

S: Travel length (mm)  
R: Bending radius (mm)  
P: Pitch = 18 mm  
K: Leeway length = 18 mm or greater

## Model number

TKP18H14 - (1) W (2) R (3) TC + (4) L - (5) - (6)

(1) Opening options	(2) Inner width	(3) Bending radius	(4) Number of links	(5) Fixed end	(6) Moving end
30 Outside openable stay	15	28		FO	MO
	40	37		FI	MI
		50			

Note: Stays and brackets are delivered uninstalled.

See page 15 for ordering information

See page 42 for model number of parts

See page 143 for product mass



# TKP18H15 Openable Stay (W20, W30)

## Structure

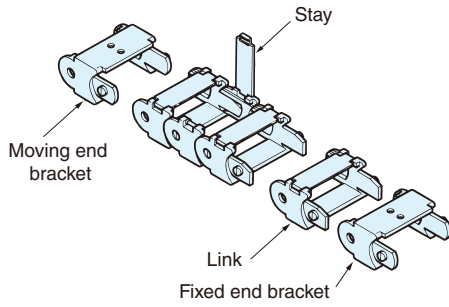

## Cross-section dimensions

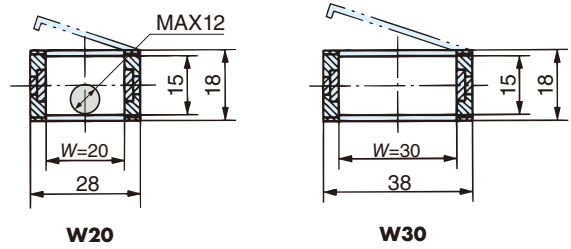

A-A arrow view

## Dimensions & brackets

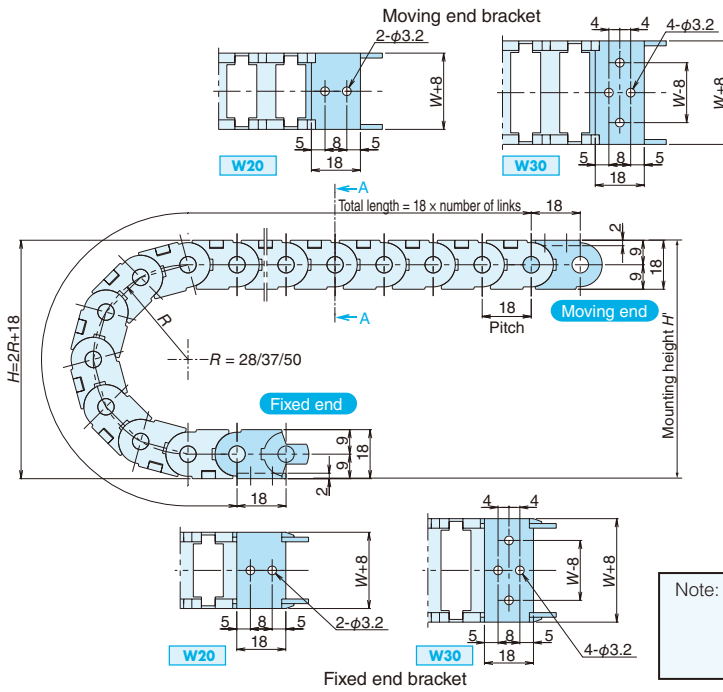

Bending radius R (mm)	Mounting height H' (mm)
28	84 to 104
37	102 to 122
50	128 to 148

Note: MO, MI, FO, and FI brackets are all common parts.

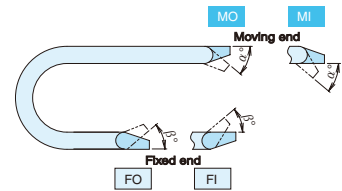

Bending radius R (mm)	Bending angle (°)	
	Moving end side (α)	Fixed end side (β)
Common for all R	0	0

Note: Design and install according to the mounting height H' dimension.

## Basic specifications

Maximum travel speed (m/min)	300 *1	
Operating temperature range (°C)	-40 to 80	
Materials	Link	Engineering plastic
	Bracket	(black)
Standard length (No. of links)	55	

Notes: ★1. 150 m/min for support roller arrangement.  
2. Cannot be used in acidic or alkaline environments.

## Load diagram

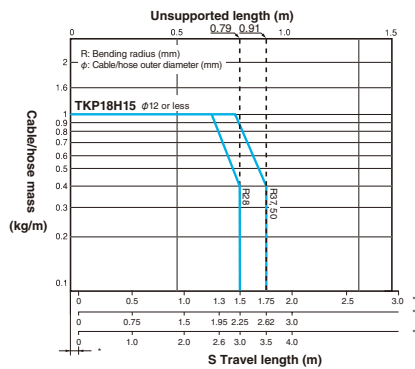

\* Includes leeway length.  
\* 0: Without support rollers  
\* 1: With support roller in 1 location  
\* 2: With support rollers in 2 locations

## Calculating no. of links

$$\text{Number of links} = \frac{S}{2} + \frac{\pi R}{P} + \frac{2K}{P}$$

Note: When fixed end is at the center of the travel length. Always round up the value after calculating.

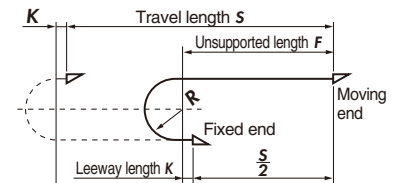

S: Travel length (mm)  
R: Bending radius (mm)  
P: Pitch = 18 mm  
K: Leeway length = 18 mm or greater

## Model number

TKP18H15 - (1) W (2) R (3) + (4) L - (5) - (6)

(1) Opening options	(2) Inner width	(3) Bending radius	(4) Number of links	(5) Fixed end	(6) Moving end
30	Outside openable stay	20		FO	MO
		28		FI	MI
		37			
		50			

Note: Brackets are delivered uninstalled.

See page 15 for ordering information

See page 42 for model number of parts

See page 143 for product mass

# TKP18H15 Single-part Frame (W15, W20, W30, W40)

## Structure

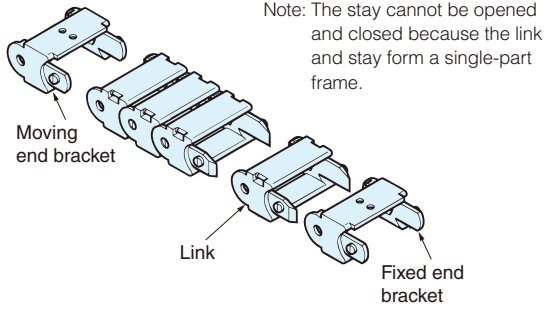

## Cross-section dimensions

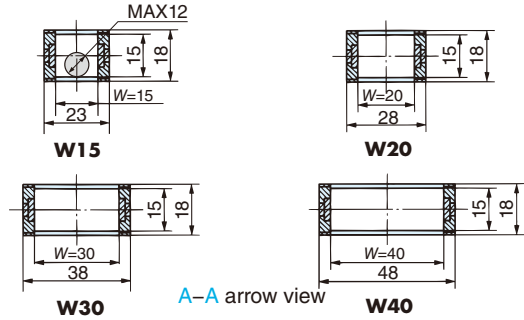

## Dimensions & brackets

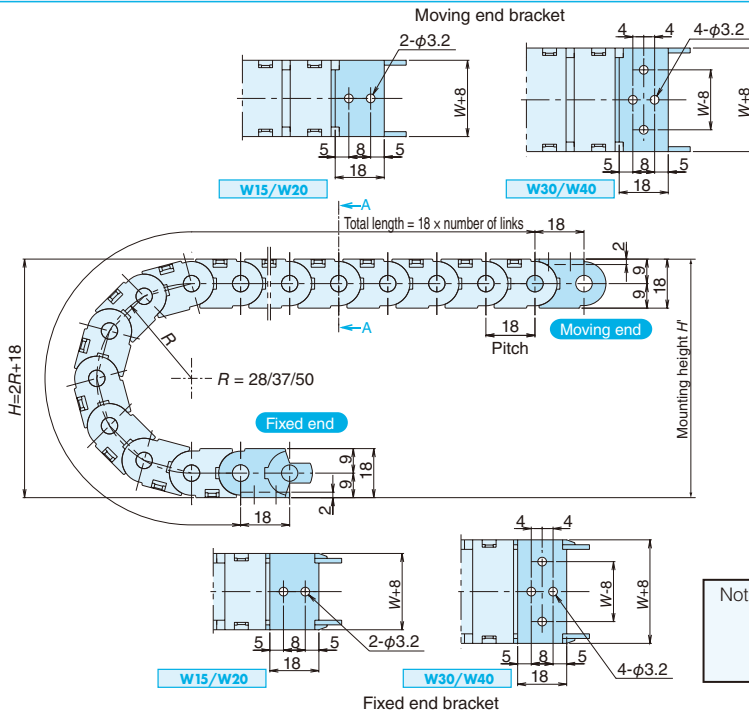

Bending radius R (mm)	Mounting height H' (mm)
28	84 to 104
37	102 to 122
50	128 to 148

Note: MO, MI, FO, and FI brackets are all common parts.

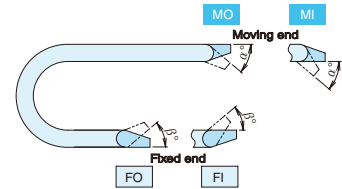

Bending radius R (mm)	Bending angle (°)	
	Moving end side (α)	Fixed end side (β)
Common for all R	0	0

Note: Design and install according to the mounting height H' dimension.

## Basic specifications

Maximum travel speed (m/min)	300 *1	
Operating temperature range (°C)	-40 to 80	
Materials	Link	Engineering plastic (black)
	Bracket	
Standard length (No. of links)	55	

Notes: ★1. 150 m/min for support roller arrangement.  
2. Cannot be used in acidic or alkaline environments.

## Load diagram

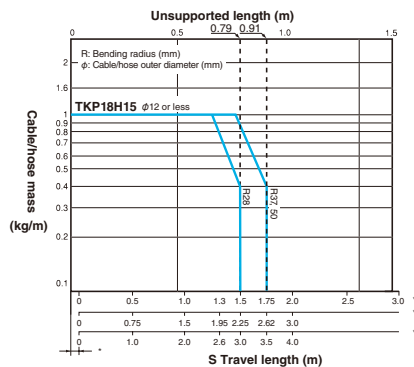

\* Includes leeway length.  
0: Without support rollers  
1: With support roller in 1 location  
2: With support rollers in 2 locations

## Calculating no. of links

$$\text{Number of links} = \frac{S}{2} + \pi R + \frac{2K}{P}$$

Note: When fixed end is at the center of the travel length. Always round up the value after calculating.

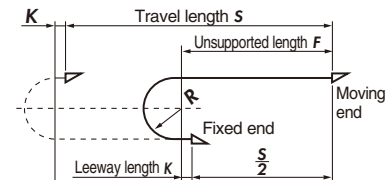

S: Travel length (mm)  
R: Bending radius (mm)  
P: Pitch = 18 mm  
K: Leeway length = 18 mm or greater

## Model number

TKP18H15 - (1) W (2) R (3) + (4) L - (5) - (6)

(1) Opening options	(2) Inner width	(3) Bending radius	(4) Number of links	(5) Fixed end	(6) Moving end
20 Single-part frame (stay cannot be opened)	15	28		FO	MO
	20	37		FI	MI
	30	50			
	40				

Note: Brackets are delivered uninstalled.

# TKP13H10 to TKP18H15 Bracket Model Number

## TKP13H10

### ■ Bracket (openable stay)

Model number	For cable carrier model number
TKP13H10W6-MO	TKP13H10-30W6R■
TKP13H10W6-MI	
TKP13H10W6-FO	
TKP13H10W6-FI	
TKP13H10W10TC-MO	TKP13H10-30W10R■TC
TKP13H10W10TC-MI	
TKP13H10W10TC-FO	
TKP13H10W10TC-FI	
TKP13H10W15-MO	TKP13H10-30W15R■
TKP13H10W15-MI	
TKP13H10W15-FO	
TKP13H10W15-FI	
TKP13H10W20TC-MO	TKP13H10-30W20R■TC
TKP13H10W20TC-MI	
TKP13H10W20TC-FO	
TKP13H10W20TC-FI	

### ■ Bracket (single-part frame)

Model number	For cable carrier model number
TKP13H10W6-MO	TKP13H10-20W6R■
TKP13H10W6-MI	
TKP13H10W6-FO	
TKP13H10W6-FI	
TKP13H10W10-MO	TKP13H10-20W10R■
TKP13H10W10-MI	
TKP13H10W10-FO	
TKP13H10W10-FI	
TKP13H10W15-MO	TKP13H10-20W15R■
TKP13H10W15-MI	
TKP13H10W15-FO	
TKP13H10W15-FI	
TKP13H10W20-MO	TKP13H10-20W20R■
TKP13H10W20-MI	
TKP13H10W20-FO	
TKP13H10W20-FI	

## TKP17H11

### ■ Bracket

Model number	For cable carrier model number
TKP17H11W10-MO	TKP17H11-30W10R17
TKP17H11W10-MI	
TKP17H11W10-FO	
TKP17H11W10-FI	

## TKP18H14/TKP18H15

### ■ Bracket (openable stay)

Model number	For cable carrier model number
TKP18H14W15TC-MO	TKP18H14-30W15R■TC
TKP18H14W15TC-MI	
TKP18H14W15TC-FO	
TKP18H14W15TC-FI	
TKP18H15W20-MO	TKP18H15-30W20R■
TKP18H15W20-MI	
TKP18H15W20-FO	
TKP18H15W20-FI	
TKP18H15W30-MO	TKP18H15-30W30R■
TKP18H15W30-MI	
TKP18H15W30-FO	
TKP18H15W30-FI	
TKP18H14W40TC-MO	TKP18H14-30W40R■TC
TKP18H14W40TC-MI	
TKP18H14W40TC-FO	
TKP18H14W40TC-FI	

### ■ Bracket (single-part frame)

Model number	For cable carrier model number
TKP18H15W15-MO	TKP18H15-20W15R■
TKP18H15W15-MI	
TKP18H15W15-FO	
TKP18H15W15-FI	
TKP18H15W20-MO	TKP18H15-20W20R■
TKP18H15W20-MI	
TKP18H15W20-FO	
TKP18H15W20-FI	
TKP18H15W30-MO	TKP18H15-20W30R■
TKP18H15W30-MI	
TKP18H15W30-FO	
TKP18H15W30-FI	
TKP18H15W40-MO	TKP18H15-20W40R■
TKP18H15W40-MI	
TKP18H15W40-FO	
TKP18H15W40-FI	

See page 15 for ordering information

See page 143 for product mass

# TKP25H15

## Structure

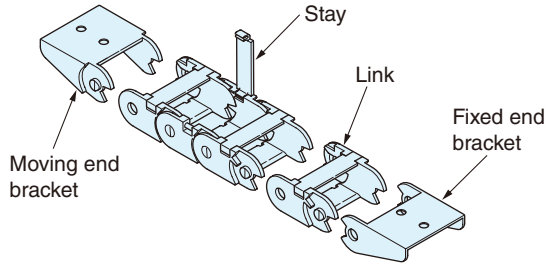

## Cross-section dimensions

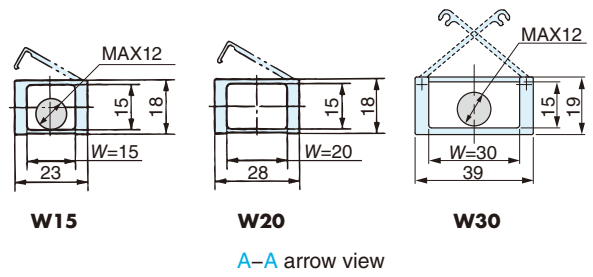

## Dimensions & brackets

### W15/W20

Note: Dimensions in ( ) are for TKP25H15W20.

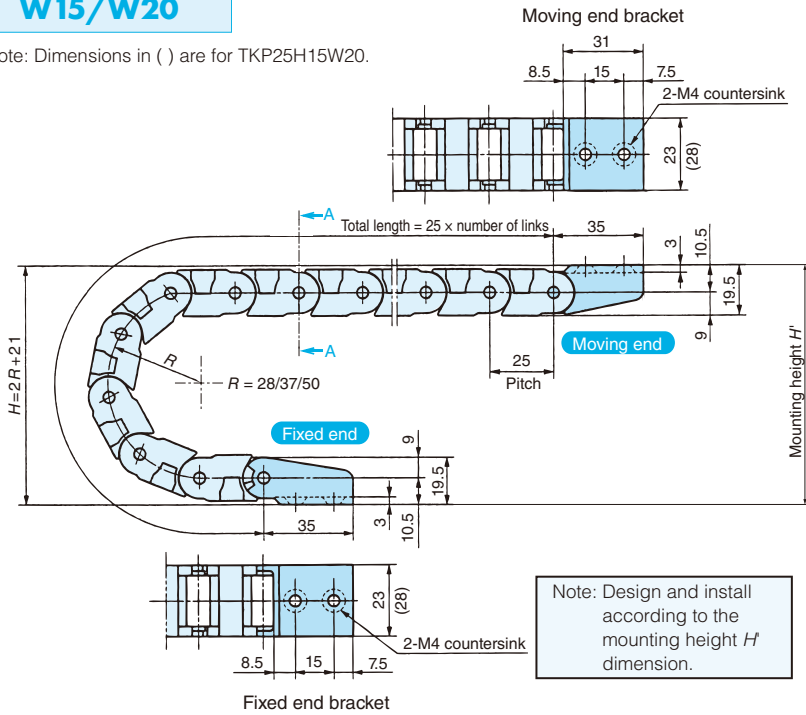

Bending radius R (mm)	Mounting height H' (mm)
28	87 to 107
37	105 to 125
50	131 to 151

Note: MO and MI brackets and FO and FI brackets are each common parts.

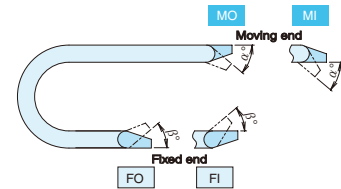

Bending radius R (mm)	Bending angle (°)	
	Moving end side ( $\alpha$ )	Fixed end side ( $\beta$ )
28	30	53
37		39
50		28

### W30

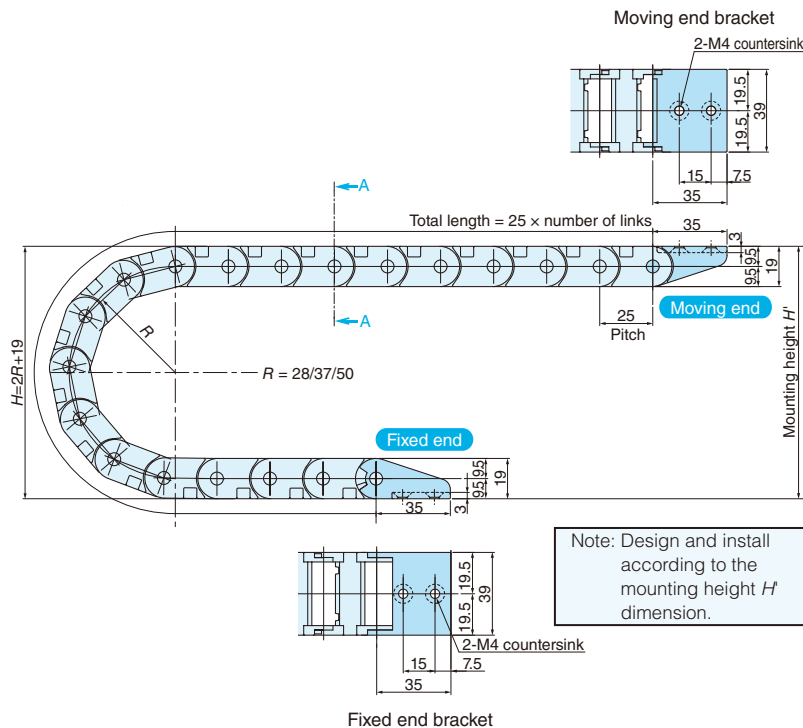

Bending radius R (mm)	Mounting height H' (mm)
28	85 to 105
37	103 to 123
50	129 to 149

Note: FO and FI brackets are common parts.

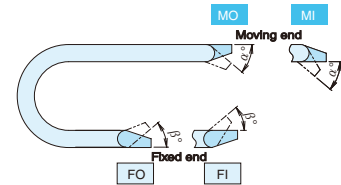

Bending radius R (mm)	Bending angle (°)	
	Moving end side ( $\alpha$ )	Fixed end side ( $\beta$ )
28	40	53
37		
50		

### Basic specifications

Maximum travel speed (m/min)	300 *1	
Operating temperature range (°C)	-40 to 80	
Materials	Link	Engineering plastic (black)
	Bracket	
Standard length (No. of links)	40	

Notes: ★1. 150 m/min for support roller arrangement.  
2. Cannot be used in acidic or alkaline environments.

### Load diagram

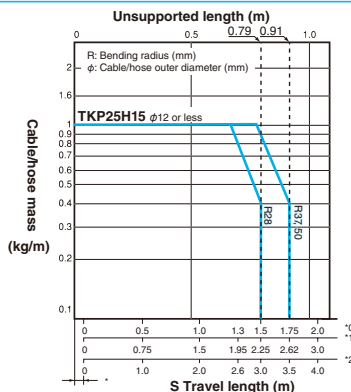

\* Includes leeway length.  
\* 0: Without support rollers  
\* 1: With support roller in 1 location  
\* 2: With support rollers in 2 locations

### Calculating no. of links

$$\text{Number of links} = \frac{S}{2} + \pi R + 2K$$

Note: When fixed end is at the center of the travel length. Always round up the value after calculating.

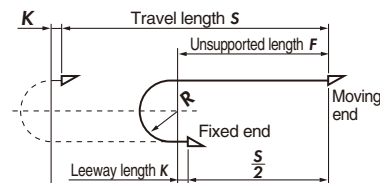

S: Travel length (mm)  
R: Bending radius (mm)  
P: Pitch = 25 mm  
K: Leeway length = 25 mm or greater

### Model number

**TKP25H15 - (1) W (2) R (3) + (4) L - (5) - (6)**

(1) Opening options	(2) Inner width	(3) Bending radius	(4) Number of links	(5) Fixed end	(6) Moving end
30 Outside openable stay	15	28		FO	MO
	20	37		FI	MI
	30	50			

Note: Brackets are delivered uninstalled.

### Bracket

Model number	For cable carrier model number
TKP25H15W15-MO	TKP25H15-30W15R■
TKP25H15W15-MI	
TKP25H15W15-FO	
TKP25H15W15-FI	
TKP25H15W20-MO	TKP25H15-30W20R■
TKP25H15W20-MI	
TKP25H15W20-FO	
TKP25H15W20-FI	
TKP25H15W30-MO	TKP25H15-30W30R■
TKP25H15W30-MI	
TKP25H15W30-FO	
TKP25H15W30-FI	

See page 15 for ordering information

See page 143 for product mass

# TKP35H22

## Structure

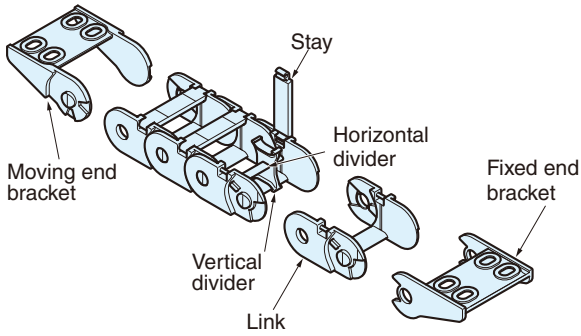

## Cross-section dimensions

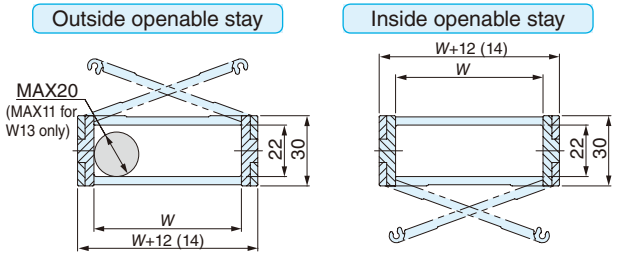

Note: Figures in ( ) are for  $W = 63$ .  
 $W = 13, 25, 38, 50, 63$   
 A-A arrow view

## Divider dimensions

### (1) When using only vertical dividers

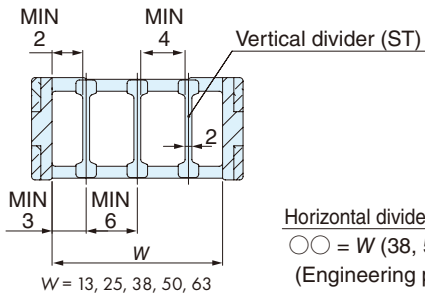

### (2) Fully-stayed multiple height separation (DSA type)

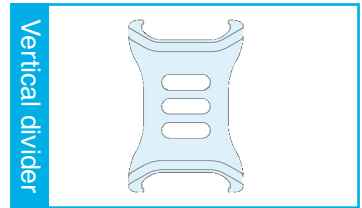
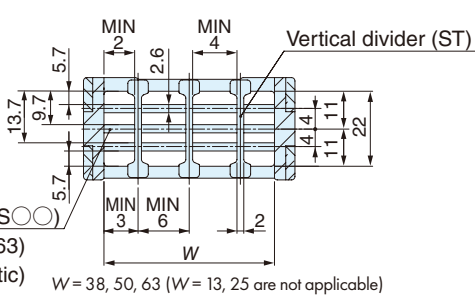

Note: Make the gap between cables/hoses and the divider or link (d in the figure to right) to whichever of the following two values is larger: 2 mm or greater or the outer diameter of the cable or hose x 0.1.

## Dimensions & brackets

### Moving end bracket

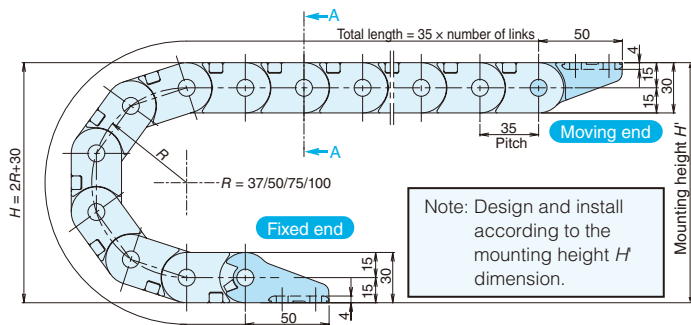
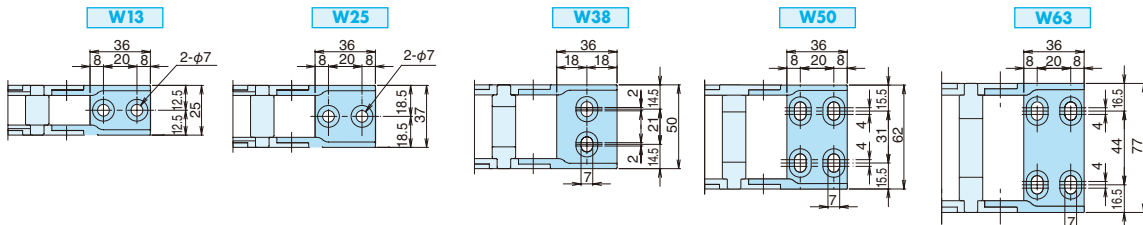

Note: Design and install according to the mounting height  $H$  dimension.

Bending radius $R$ (mm)	Mounting height $H'$ (mm)
37	114 to 134
50	140 to 160
75	190 to 210
100	240 to 260

Note: MO and MI brackets and FO and FI brackets are each common parts.

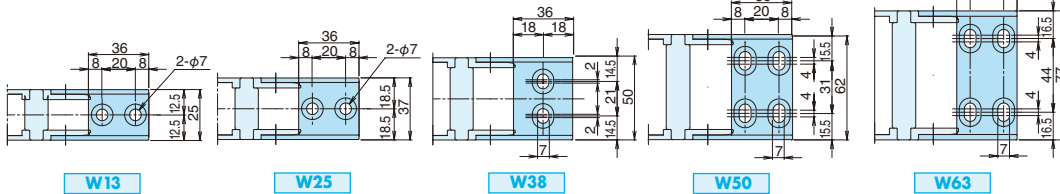
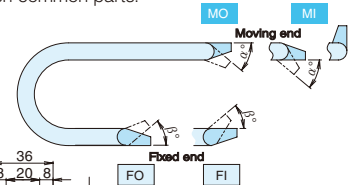

### Fixed end bracket

Bending radius $R$ (mm)	Bending angle ( $^\circ$ )	
	Moving end side ( $\alpha$ )	Fixed end side ( $\beta$ )
37	0	60
50		
75		
100		

### Basic specifications

Maximum travel speed (m/min)	300 *1	
Operating temperature range (°C)	-40 to 80	
Materials	Link	Engineering plastic
	Bracket	
	Vertical divider	Engineering plastic (white)
	Horizontal divider	
Standard length (No. of links)	25	

Notes: ★1. 150 m/min for support roller arrangement.  
2. Cannot be used in acidic or alkaline environments.

### Load diagram

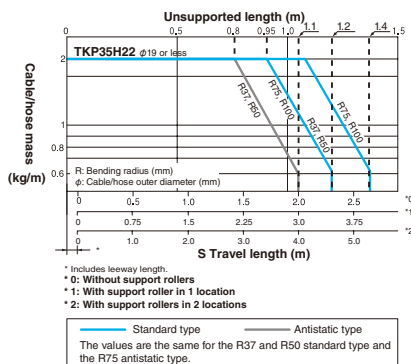

Note: Use the gliding arrangement (page 127) if capacity is exceeded.

### Calculating no. of links

$$\text{Number of links} = \frac{S}{2} + \pi R + 2K$$

Note: When fixed end is at the center of the travel length. Always round up the value after calculating.

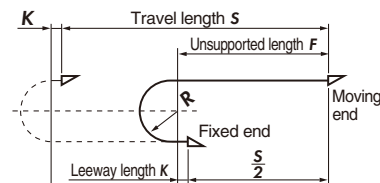

S: Travel length (mm)  
R: Bending radius (mm)  
P: Pitch = 35 mm  
K: Leeway length = 35 mm or greater

### Model number

**TKP35H22 - (1) W (2) R (3) + (4)L - (5) - (6)**

(1) Opening options	(2) Inner width	(3) Bending radius	(4) Number of links	(5) Fixed end	(6) Moving end
30 Outside openable stay	13	37		FO	MO
40 Inside openable stay	25	50		FI	MI
	38	75			
	50	100			
	63				

Notes: 1. Install dividers every 2 links.  
2. Brackets and dividers are delivered uninstalled.  
3. Refer to page 131 for model number for the gliding arrangement.  
4. When ordering a circular travel arrangement, the made-to-order content will depend on the operating conditions. Contact a Tsubaki representative for further information.

#### ■ Divider

Type	Model number	Part	Unit
(1) Vertical divider	TKP35H22-ST	1 vertical divider	K (pcs)
(2) Horizontal divider (For DSA type)	TKP35H22-HS (Dimension W) W = 38/50/63	1 horizontal divider	K (pcs)

#### DSA type

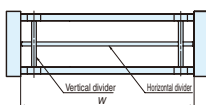

#### ■ Vertical divider

Model number	For cable carrier model number
TKP35H22-ST	TKP35H22-30/40W ■ ■ ■

#### ■ Horizontal divider

Model number	For cable carrier model number
TKP35H22-HS38	TKP35H22-30/40W38R ■ ■
TKP35H22-HS50	TKP35H22-30/40W50R ■ ■
TKP35H22-HS63	TKP35H22-30/40W63R ■ ■

#### ■ Bracket

Model number	For cable carrier model number
TKP35H22W13-MO	TKP35H22-30/40W13R ■ ■
TKP35H22W13-MI	
TKP35H22W13-FO	
TKP35H22W13-FI	TKP35H22-30/40W25R ■ ■
TKP35H22W25-MO	
TKP35H22W25-MI	
TKP35H22W25-FO	
TKP35H22W25-FI	TKP35H22-30/40W38R ■ ■
TKP35H22W38-MO	
TKP35H22W38-MI	
TKP35H22W38-FO	
TKP35H22W38-FI	TKP35H22-30/40W50R ■ ■
TKP35H22W50-MO	
TKP35H22W50-MI	
TKP35H22W50-FO	
TKP35H22W50-FI	TKP35H22-30/40W63R ■ ■
TKP35H22W63-MO	
TKP35H22W63-MI	
TKP35H22W63-FO	
TKP35H22W63-FI	

See page 15 for ordering information

See page 143 for product mass

# TKP35H32

## Structure

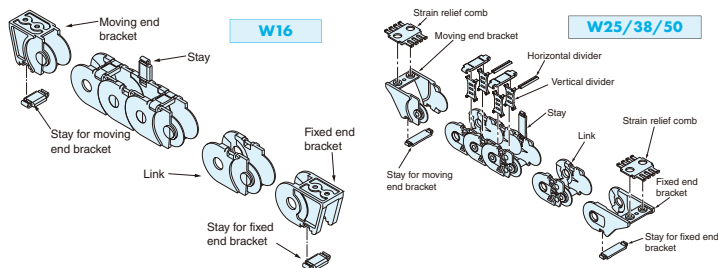

Note: The stay, stay for the moving end bracket, and stay for the fixed end bracket are common parts.

## Cross-section dimensions

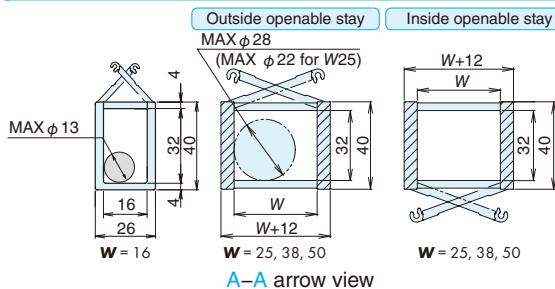

Note: Cable carrier must be used at low speeds and frequencies when cables and hoses are stacked inside.

## Divider dimensions

(1) When using only vertical dividers

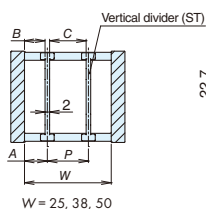

(2) Fully-stayed multiple height separation (DSA type)

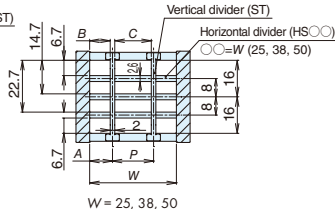

Vertical divider (fastening method)	Inner width W (mm)	A (mm)	B (mm)	P (mm)	C (mm)
ST (sliding installation)	25/38/50	3 to 21	2 to 20	6 to 44	4 to 42
ST (fixable installation)	25	4.5 to 14.5 (2 mm increments)	3.5 to 13.5 (2 mm increments)	6 to 16 (2 mm increments)	4 to 14 (2 mm increments)
	38	5 to 21 (2 mm increments)	4 to 20 (2 mm increments)	6 to 28 (2 mm increments)	4 to 26 (2 mm increments)
	50	5 to 21 (2 mm increments)	4 to 20 (2 mm increments)	6 to 40 (2 mm increments)	4 to 38 (2 mm increments)

Notes: 1. Vertical dividers and horizontal dividers cannot be installed to the W16.  
2. The maximum values for A, B, P, and C are applied when using horizontal dividers. 2 or more vertical dividers are required when using a horizontal divider.

### Notes:

A: Distance from center of vertical divider to end face of link  
B: Gap between vertical divider and link  
P: Distance between the centers of neighboring vertical dividers  
C: Gap between neighboring vertical dividers

Note: Make the gap between cables/hoses and the divider or link (d in the figure to right) to whichever of the following two values is larger: 2 mm or greater or the outer diameter of the cable or hose x 0.1.

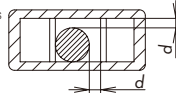

Vertical divider (fastening method)

◆ Fixable installation and sliding installation can be selected by the direction the same part is installed.

Stay opening side

Round hole

[sliding installation]

Stay opening side

Round hole

[fixable installation]

## Dimensions & brackets

### W16

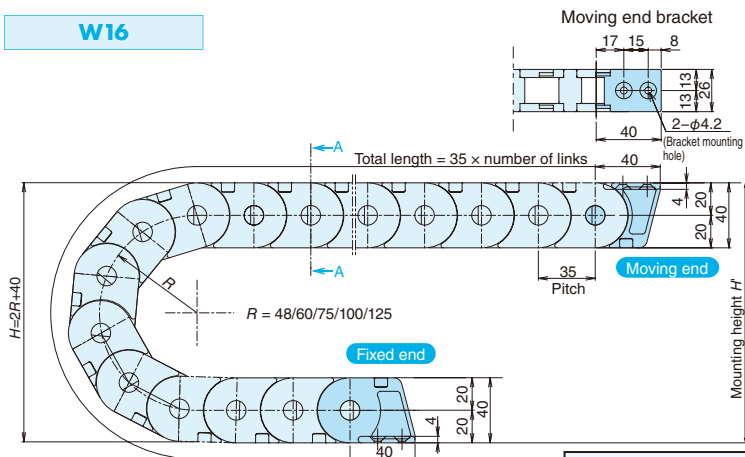

Note: Design and install according to the mounting height H dimension.

Bending radius R (mm)	Mounting height H' (mm)
48	146 to 166
60	170 to 190
75	200 to 220
100	250 to 270
125	300 to 320

Note: MO and MI brackets are common parts.

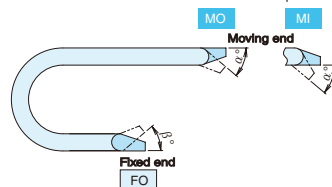

Bending radius R (mm)	Bending angle (°)	
	Moving end side (α)	Fixed end side (β)
48	28	27
60		
75		
100		
125		

### W25/38/50

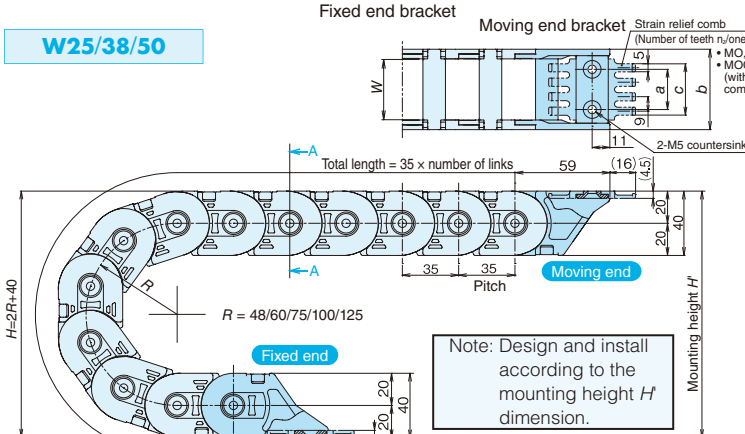

Note: Design and install according to the mounting height H dimension.

Bending radius R (mm)	Mounting height H' (mm)
48	146 to 166
60	170 to 190
75	200 to 220
100	250 to 270
125	300 to 320

Note: MO and MI brackets and FO and FI brackets are each common parts.

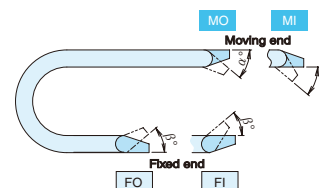

Bending radius R (mm)	Bending angle (°)	
	Moving end side (α)	Fixed end side (β)
48	17	27
60		17
75		10
100		3
125		0

W (mm)	a (mm)	b (mm)	c (mm)	Strain relief comb n <sub>z</sub> (Number of teeth)
25	12	37	23	3
38	25	50	32	4
50	37	62	50	6



### Basic specifications

Maximum travel speed (m/min)	300 *1	
Operating temperature range (°C)	-40 to 80	
Materials	Link	Engineering plastic (black)
	Bracket	
	Vertical divider *2	Engineering plastic (white)
	Horizontal divider *2	
Standard length (No. of links)	25	

Notes: ★1. 150 m/min for support roller arrangement.  
 ★2. Vertical dividers and horizontal dividers cannot be installed to the W16.  
 3. Cannot be used in acidic or alkaline environments.

### Load diagram

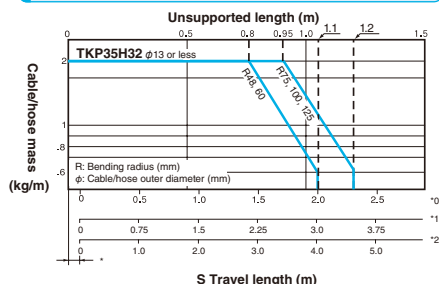

\* Includes leeway length.  
 \* 0: Without support rollers  
 \* 1: With support roller in 1 location  
 \* 2: With support rollers in 2 locations

### Calculating no. of links

$$\text{Number of links} = \frac{S}{2} + \pi R + 2K$$

Note: When fixed end is at the center of the travel length. Always round up the value after calculating.

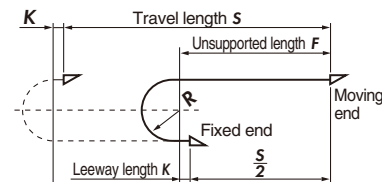

S: Travel length (mm)  
 R: Bending radius (mm)  
 P: Pitch = 35 mm  
 K: Leeway length = 35 mm or greater

### Model number

#### W16

TKP35H32 - (1) W (2) R (3) + (4) L - (5) - (6)

(1) Opening options	(2) Inner width	(3) Bending radius	(4) Number of links	(5) Fixed end	(6) Moving end
30 Outside openable stay	16	48 100 60 125 75		FO	MO MI

#### W25/38/50

TKP35H32 - (1) W (2) R (3) + (4) L - (5) - (6)

(1) Opening options	(2) Inner width	(3) Bending radius	(4) Number of links	(5) Fixed end	(6) Moving end
30 Outside openable stay	25	48 100		FO FOCL	MO MOCL
40 Inside openable stay	38	60 125		FI FICL	MI MICL
	50	75			

Notes: 1. Install dividers every 2 links.  
 2. Brackets, vertical dividers, horizontal dividers, and strain relief combs are delivered uninstalled.  
 3. Vertical dividers and horizontal dividers cannot be installed with an inner width of 16 mm.

#### Divider

Type	Model number	Part	Unit
(1) Vertical divider	TKP35H32-ST	1 vertical divider	K (pcs)
(2) Horizontal divider (For DSA type)	TKP35H32-HS (Dimension W) W = 25/38/50	1 horizontal divider	K (pcs)

#### DSA type

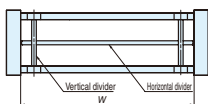

#### Vertical divider

Model number	For cable carrier model number
TKP35H32-ST	TKP35H32-30/40W■■ (■■ = 25/38/50)

#### Horizontal divider

Model number	For cable carrier model number
TKP35H32-HS25	TKP35H32-30/40W25R■■
TKP35H32-HS38	TKP35H32-30/40W38R■■
TKP35H32-HS50	TKP35H32-30/40W50R■■

#### Strain relief comb

Model number	Applicable bracket
TKP35H32W25-CL-P	TKP35H32W25-○○
TKP35H32W38-CL-P	TKP35H32W38-○○
TKP35H32W50-CL-P	TKP35H32W50-○○

#### Bracket

Model number	For cable carrier model number
TKP35H32W16-MO	TKP35H32-30W16R■■
TKP35H32W16-MI	
TKP35H32W16-FO	
TKP35H32W25-MO	TKP35H32-30/40W25R■■
TKP35H32W25-MI	
TKP35H32W25-FO	
TKP35H32W25-FI	TKP35H32-30/40W38R■■
TKP35H32W38-MO	
TKP35H32W38-MI	
TKP35H32W38-FO	TKP35H32-30/40W50R■■
TKP35H32W38-FI	
TKP35H32W50-MO	
TKP35H32W50-MI	TKP35H32-30/40W50R■■
TKP35H32W50-FO	
TKP35H32W50-FI	

#### Bracket (with strain relief comb)

Model number	For cable carrier model number
TKP35H32W25-MOCL	TKP35H32-30/40W25R■■
TKP35H32W25-MICL	
TKP35H32W25-FOCL	
TKP35H32W25-FICL	TKP35H32-30/40W38R■■
TKP35H32W38-MOCL	
TKP35H32W38-MICL	
TKP35H32W38-FOCL	TKP35H32-30/40W50R■■
TKP35H32W38-FICL	
TKP35H32W50-MOCL	
TKP35H32W50-MICL	TKP35H32-30/40W50R■■
TKP35H32W50-FOCL	
TKP35H32W50-FICL	

# TKP45H25

## Structure

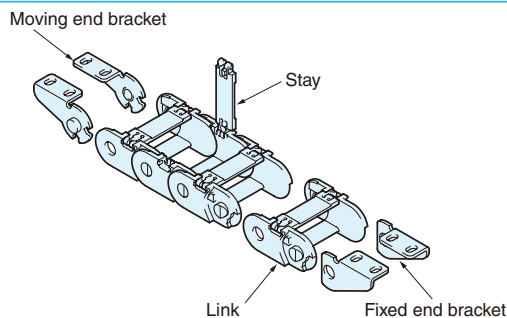

## Cross-section dimensions

### Outside openable stay

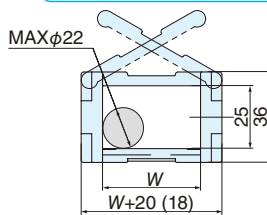

### Inside openable stay

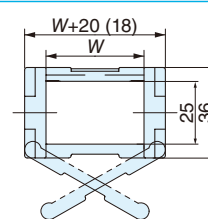

Note: Figures in ( ) are for W = 38.

W = 38, 58, 78, 103

A-A arrow view

## Divider dimensions

### (1) When using only vertical dividers

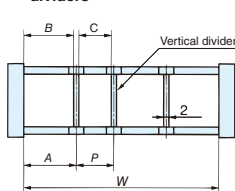

### (2) Fully-stayed 2-layers height separation (DSA type)

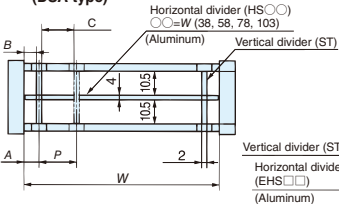

### (3) Partial 2-layers height separation (DSB type)

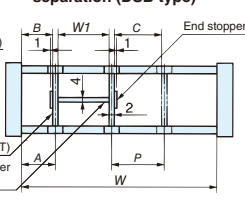

Vertical divider (fastening method)	Inner width W (mm)	A (mm)	B (mm)	P (mm)	C (mm)	W1 (mm)
ST (sliding installation)	38	4	3	8	6	11
	58	to	to	to	to	to
	78	43	42	95	93	W-10
	103					(1 mm increments)

### Notes:

- A: Distance from center of vertical divider to end face of link
- B: Gap between vertical divider and link
- P: Distance between the centers of neighboring vertical dividers
- C: Gap between neighboring vertical dividers

Note: Make the gap between cables/hoses and the divider or link (d in the figure to right) to whichever of the following two values is larger: 2 mm or greater or the outer diameter of the cable or hose x 0.1.

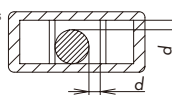

## Vertical divider



## Dimension drawings

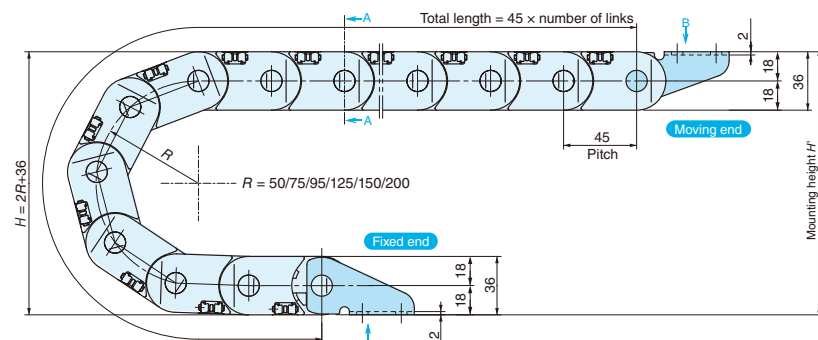

Note: Design and install according to the mounting height H dimension.

Bending radius R (mm)	Mounting height H' (mm)
50	146 to 166
75	196 to 216
95	236 to 256
125	296 to 316
150	346 to 366
200	446 to 466

Note: The steel bracket can be installed in a variety of directions.

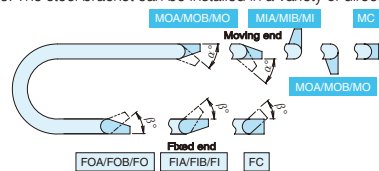

Bending radius R (mm)	Bending angle (°)	
	Moving end side (α)	Fixed end side (β)
Common for all R	0	25

## Steel bracket variants and dimensions

	Connection surface inside			Connection surface outside			Flange mounting		Single-part steel bracket		
Moving end bracket	<b>MOA/MIA</b>			<b>MOB/MIB</b>			<b>MC</b>		<b>MO/MI</b>		
	B arrow view			B arrow view			B arrow view		B arrow view		
Fixed end bracket	<b>FOA/FIA</b>			<b>FOB/FIB</b>			<b>FC</b>		<b>FO/FI</b>		
	C arrow view			C arrow view			C arrow view		C arrow view		
Inner width W (mm)	A (mm)	B (mm)	C (mm)	A (mm)	B (mm)	C (mm)	A (mm)	B (mm)	A (mm)	B (mm)	C (mm)
38	23	48	52	72	88	96	70	90	25	48	53
58	44	69	73	93	109	117	91	111	44	69	74
78	64	89	93	113	129	137	111	131	64	89	94
103	89	114	118	138	154	162	136	156	90	114	119

Basic specifications

Maximum travel speed (m/min)	300 *1	
Operating temperature range (°C)	-40 to 80	
Materials	Link	Engineering plastic (black)
	Bracket	Steel (Trivalent chromate plating)
	Vertical divider	Engineering plastic (black)
	Horizontal divider	For DSA type (HS) Aluminum For DSB type (EHS) Engineering plastic (black) + aluminum
Standard length (No. of links)	20	

Notes: ★1. 150 m/min for support roller arrangement.  
2. Cannot be used in acidic or alkaline environments.

Load diagram

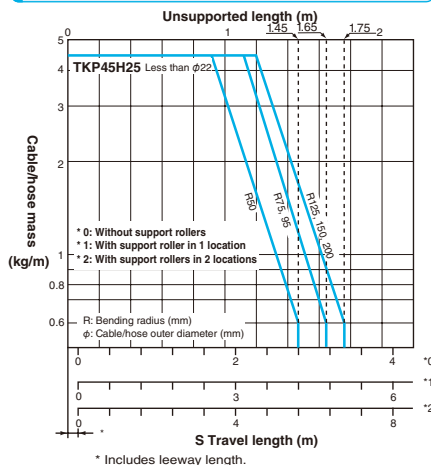

Note: Use the gliding arrangement (page 127) if capacity is exceeded.

Calculating no. of links

$$\text{Number of links} = \frac{S}{P} + \pi R + 2K$$

Note: When fixed end is at the center of the travel length. Always round up the value after calculating.

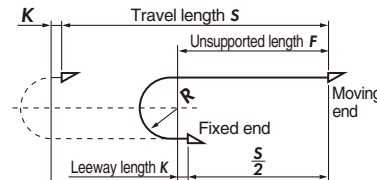

S: Travel length (mm)  
R: Bending radius (mm)  
P: Pitch = 45 mm  
K: Leeway length = 45 mm or greater

Model number

TKP45H25 - (1) W (2) R (3) + (4) L - (5) - (6)

(1) Opening options	(2) Inner width	(3) Bending radius	(4) Number of links	(5) Fixed end	(6) Moving end
30 Outside openable stay	38	50		FOA	MOA
40 Inside openable stay	58	75		FIA	MIA
	78	95		FOB	MOB
	103	125		FIB	MIB
		150		FC	MC
		200		FO	MO
				FI	MI

Notes: 1. Steel brackets (excluding single-part steel brackets) and vertical dividers are common parts regardless of the inner width.  
2. Install dividers every 2 links.  
3. Steel brackets and dividers are delivered uninstalled.  
4. Refer to page 131 for model number for the gliding arrangement.  
5. When ordering a circular travel arrangement, the made-to-order content will depend on the operating conditions. Contact a Tsubaki representative for further information.

Divider

Type	Model number	Part	Unit
(1) Vertical divider	TKP45H25-ST	1 vertical divider	K (pcs)
(2) Horizontal divider (For DSA type)	TKP45H25-HS (Dimension W) W = 38/58/78/103	1 horizontal divider	K (pcs)
(3) Horizontal divider with end stoppers (For DSB type)	TKP45H25-EHS (Dimension W1) W1 = 11 to (W-10); 1 mm increments	1 horizontal divider 2 end stoppers	K (pcs)

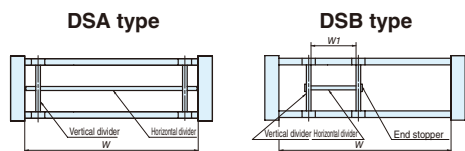

Vertical divider

Model number	For cable carrier model number
TKP45H25-ST	TKP45H25-30/40W ■■ R ■■

Horizontal divider

Model number	For cable carrier model number
TKP45H25-HS38	TKP45H25-30/40W38R ■■
TKP45H25-HS58	TKP45H25-30/40W58R ■■
TKP45H25-HS78	TKP45H25-30/40W78R ■■
TKP45H25-HS103	TKP45H25-30/40W103R ■■

Horizontal divider with end stoppers

Model number
TKP45H25-EHS □ □

□ □: Integer between 11 and 93

Split steel bracket

Model number	For cable carrier model number
TKP45H25-MOA	TKP45H25-30/40W ■■ R ■■
TKP45H25-MIA	
TKP45H25-MOB	
TKP45H25-MIB	
TKP45H25-MC	
TKP45H25-FOA	
TKP45H25-FIA	
TKP45H25-FOB	
TKP45H25-FIB	
TKP45H25-FC	

Single-part steel bracket

Model number	For cable carrier model number
TKP45H25W38-MO	TKP45H25-30/40W38R ■■
TKP45H25W38-MI	
TKP45H25W38-FO	
TKP45H25W38-FI	
TKP45H25W58-MO	TKP45H25-30/40W58R ■■
TKP45H25W58-MI	
TKP45H25W58-FO	
TKP45H25W58-FI	
TKP45H25W78-MO	TKP45H25-30/40W78R ■■
TKP45H25W78-MI	
TKP45H25W78-FO	
TKP45H25W78-FI	
TKP45H25W103-MO	TKP45H25-30/40W103R ■■
TKP45H25W103-MI	
TKP45H25W103-FO	
TKP45H25W103-FI	



**Basic specifications**

Maximum travel speed (m/min)	300 *1	
Operating temperature range (°C)	-40 to 80	
Materials	Link	Engineering plastic (black)
	Bracket	Steel (Trivalent chromate plating)
	Vertical divider	Engineering plastic (black)
	Horizontal divider	For DSA type (HS) For DSB type (EHS)
Standard length (No. of links)	20	

Notes: ★1. 150 m/min for support roller arrangement.  
2. Cannot be used in acidic or alkaline environments.

**Load diagram**

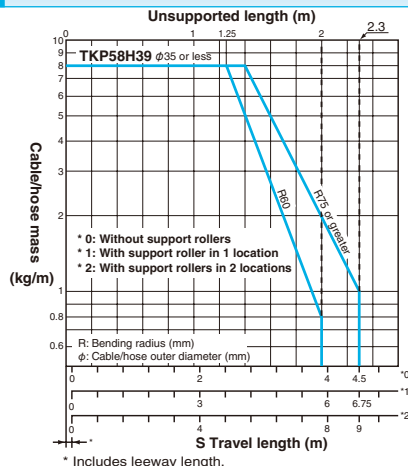

Note: Use the gliding arrangement (page 127) if capacity is exceeded.

**Calculating no. of links**

$$\text{Number of links} = \frac{S}{2} + \pi R + 2K$$

Note: When fixed end is at the center of the travel length. Always round up the value after calculating.

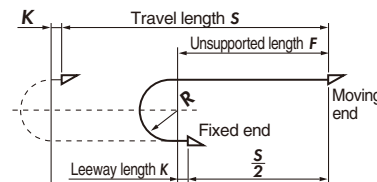

S: Travel length (mm)  
R: Bending radius (mm)  
P: Pitch = 58 mm  
K: Leeway length = 58 mm or greater

**Model number**

**TKP58H39 - (1) W (2) R (3) + (4)L - (5) - (6)**

(1) Opening options		(2) Inner width	(3) Bending radius	(4) Number of links	(5) Fixed end	(6) Moving end
30	Outside openable stay	50	60		FOA	MOA
40	Inside openable stay	75	75		FIA	MIA
		100	90		FOB	MOB
		125	125		FIB	MIB
			150		FC	MC
			200		FO	MO
					FI	MI

Notes: 1. Steel brackets (excluding single-part steel brackets) and vertical dividers are common parts regardless of the inner width.  
2. Install dividers every 2 links.  
3. Steel brackets and dividers are delivered uninstalled.  
4. Refer to page 131 for model number for the gliding arrangement.  
5. When ordering a circular travel arrangement, the made-to-order content will depend on the operating conditions. Contact a Tsubaki representative for further information.

**Divider**

Type	Model number	Part	Unit
(1) Vertical divider	TKP58H39-ST	1 vertical divider	K (pcs)
(2) Horizontal divider (For DSA type)	TKP58H39-HS (Dimension W) W = 50/75/100/125	1 horizontal divider	K (pcs)
(3) Horizontal divider with end stoppers (For DSB type)	TKP58H39-EHS (Dimension W1) W1 = 11 to (W-13); 1 mm increments	1 horizontal divider 2 end stoppers	K (pcs)

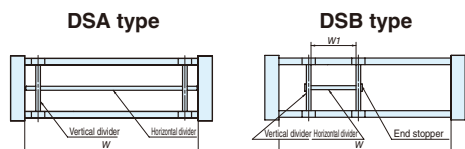

**Vertical divider**

Model number	For cable carrier model number
TKP58H39-ST	TKP58H39-30/40W ■■R ■■

**Horizontal divider**

Model number	For cable carrier model number
TKP58H39-HS50	TKP58H39-30/40W50R ■■
TKP58H39-HS75	TKP58H39-30/40W75R ■■
TKP58H39-HS100	TKP58H39-30/40W100R ■■
TKP58H39-HS125	TKP58H39-30/40W125R ■■

**Horizontal divider with end stoppers**

Model number
TKP58H39-EHS □□

□□: Integer between 11 and 112

**Split steel bracket**

Model number	For cable carrier model number
TKP58H39-MOA	TKP58H39-30/40W ■■R ■■
TKP58H39-MIA	
TKP58H39-MOB	
TKP58H39-MIB	
TKP58H39-MC	TKP58H39-30/40W ■■R ■■
TKP58H39-FOA	
TKP58H39-FIA	
TKP58H39-FOB	
TKP58H39-FIB	
TKP58H39-FC	

**Single-part steel bracket**

Model number	For cable carrier model number
TKP58H39W50-MO	TKP58H39-30/40W50R ■■
TKP58H39W50-MI	
TKP58H39W50-FO	
TKP58H39W50-FI	TKP58H39-30/40W75R ■■
TKP58H39W75-MO	
TKP58H39W75-MI	
TKP58H39W75-FO	
TKP58H39W75-FI	
TKP58H39W100-MO	
TKP58H39W100-MI	
TKP58H39W100-FO	
TKP58H39W100-FI	
TKP58H39W125-MO	TKP58H39-30/40W125R ■■
TKP58H39W125-MI	
TKP58H39W125-FO	
TKP58H39W125-FI	

# TKP62H34

## Structure

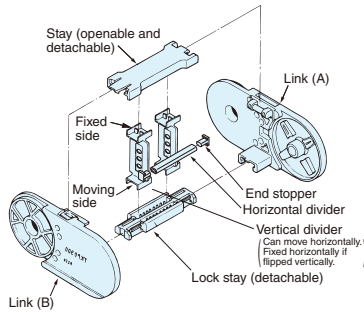

## Cross-section dimensions

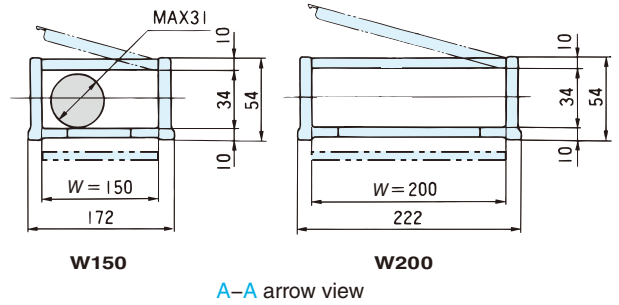

## Divider dimensions

### (1) When using only vertical dividers

### (2) Fully-stayed 2-layers height separation (DSA type)

### (3) Partial 2-layers height separation (DSB type)

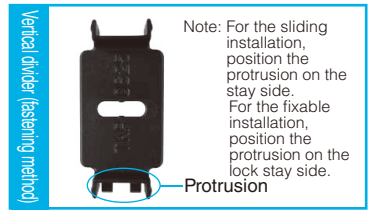
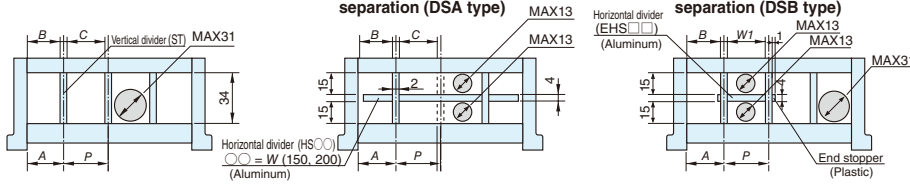

Vertical divider (fastening method)	Inner width W (mm)	A (mm)	B (mm)	P (mm)	C (mm)	W1 (mm)
ST (sliding installation)	Common for all widths	27.5 to 42.5	26.5 to 41.5	15 to 135	13 to 133	13 to 133 (adjustable in 1 mm increments)
ST (fixable installation)	150	min 27.5	min 26.5	15 to 95	13 to 93	13 to 93
	200	min 27.5	min 26.5	15 to 145	13 to 143	13 to 133

#### Notes:

- A : Distance from center of vertical divider to end face of link
- B : Gap between vertical divider and link
- P : Distance between the centers of neighboring vertical dividers
- C : Gap between neighboring vertical dividers

Note: Make the gap between cables/hoses and the divider or link (d in the figure to right) to whichever of the following two values is larger: 2 mm or greater or the outer diameter of the cable or hose x 0.1.

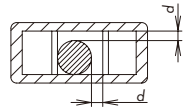

- Notes: 1. The maximum values for gaps A and P are applied when using horizontal dividers.  
 2. The divider can slide between W-55. The fastening pitch of fixable dividers is 5 mm increments. However, the pitch of neighboring dividers is 15 mm or greater.

## Dimension drawings

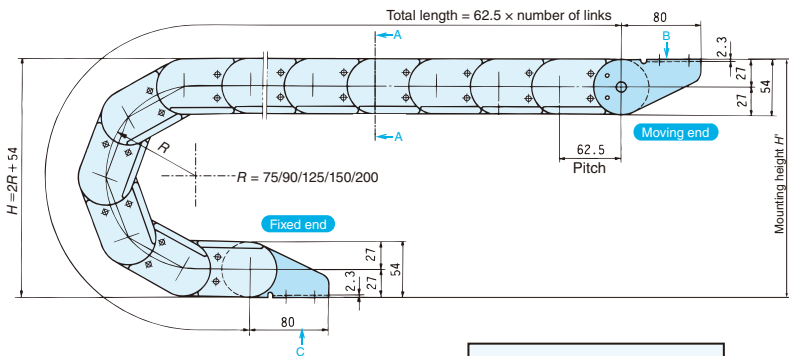

Note: Design and install according to the mounting height H' dimension.

Bending radius R (mm)	Mounting height H' (mm)
75	214 to 234
90	244 to 264
125	314 to 334
150	364 to 384
200	464 to 484

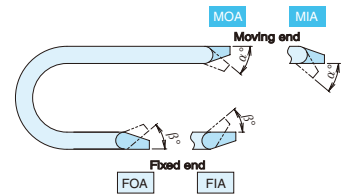

Bending radius R (mm)	Bending angle (°)		
	MOA Moving end side (α)	MIA Moving end side (α)	Fixed end side (β)
75	56	39	FOA: 64
90	47	39	
125	35	35	
150	30	30	FIA: 38
200	24	24	

## Steel bracket variants and dimensions

Inner width W (mm)	Outside mounting			Inside mounting		
	MOA Moving end bracket	FOA Fixed end bracket	MIA Fixed end bracket	MIA Moving end bracket	FIA Fixed end bracket	FIA Fixed end bracket
150	A: 123	B: 155	C: 167	A: 123	B: 155	C: 167
200	A: 173	B: 205	C: 217	A: 173	B: 205	C: 217

### Basic specifications

Maximum travel speed (m/min)		300 *1
Operating temperature range (°C)		-40 to 80
Materials	Link	Engineering plastic (black)
	Bracket	Steel (Trivalent chromate plating)
	Vertical divider	Engineering plastic (black)
	Horizontal divider	For DSA type (HS) Aluminum For DSB type (EHS) Engineering plastic (black) + aluminum
Standard length (No. of links)		60

Notes: ★1. 150 m/min for support roller arrangement.  
2. Cannot be used in acidic or alkaline environments.

### Load diagram

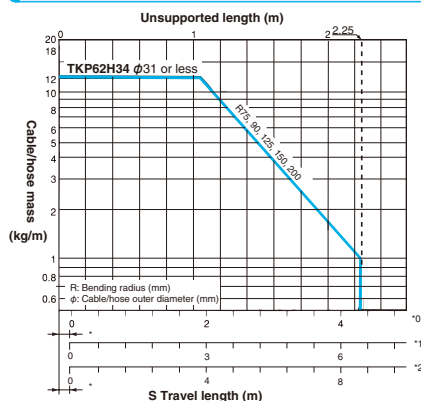

\* Includes leeway length.  
\* 0: Without support rollers  
\* 1: With support roller in 1 location  
\* 2: With support rollers in 2 locations  
Note: Use the gliding arrangement (page 127) if capacity is exceeded.

### Calculating no. of links

$$\text{Number of links} = \frac{\frac{S}{2} + \pi R + 2K}{P}$$

Note: When fixed end is at the center of the travel length. Always round up the value after calculating.

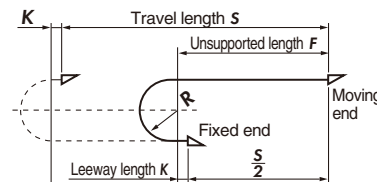

S: Travel length (mm)  
R: Bending radius (mm)  
P: Pitch = 62.5 mm  
K: Leeway length = 63 mm or greater

### Model number

<b>TKP62H34W</b>	<b>(1)</b>	<b>R</b>	<b>(2)</b>	<b>+</b>	<b>(3)</b>	<b>L</b>	<b>-</b>	<b>(4)</b>	<b>-</b>	<b>(5)</b>
	(1) Inner width		(2) Bending radius		(3) Number of links		(4) Fixed end		(5) Moving end	
	150		75				FOA		MOA	
	200		90				FIA		MIA	
			125							
			150							
			200							

Notes: 1. Steel brackets and vertical dividers are common parts regardless of the inner width.  
2. Install dividers every 2 links.  
3. The moving end bracket is delivered installed. The fixed end bracket and dividers are delivered uninstalled.  
4. Refer to page 131 for model number for the gliding arrangement.  
5. When ordering a circular travel arrangement, the made-to-order content will depend on the operating conditions. Contact a Tsubaki representative for further information.

#### ■ Divider

Type	Model number	Part	Unit
(1) Vertical divider	TKP62H34-ST	1 vertical divider	K (pcs)
(2) Horizontal divider (For DSA type)	TKP62H34-HS (Dimension W) W = 150/200	1 horizontal divider	K (pcs)
(3) Horizontal divider with end stoppers (For DSB type)	TKP62H34-EHS (Dimension W1) W1 = 13 to 133: 1 mm increments	1 horizontal divider 2 end stoppers	K (pcs)

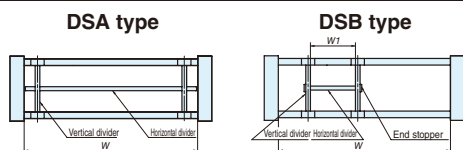

#### ■ Vertical divider

Model number	For cable carrier model number
TKP62H34-ST	TKP62H34W ■■ R ■■

#### ■ Horizontal divider

Model number	For cable carrier model number
TKP62H34-HS150	TKP62H34W150R ■■
TKP62H34-HS200	TKP62H34W200R ■■

#### ■ Horizontal divider with end stoppers

Model number
TKP62H34-EHS □ □

□ □: Integer between 13 and 133

#### ■ Steel bracket

Model number	For cable carrier model number
TKP62H34-MOA	TKP62H34W ■■ R ■■
TKP62H34-MIA	
TKP62H34-FOA	
TKP62H34-FIA	TKP62H34W ■■ R ■■

See page 15 for ordering information

See page 144 for product mass

# TKP68H46

(Patented)

## Structure

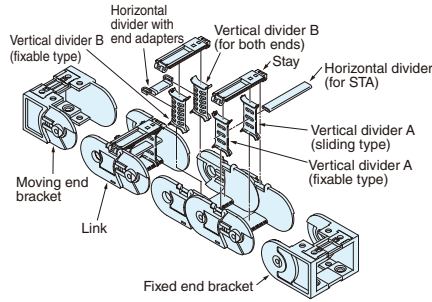

## Cross-section dimensions

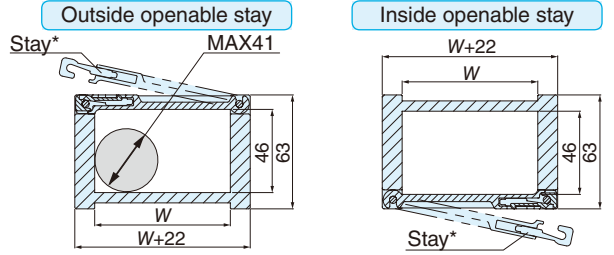

**W = 75, 100, 125, 150, 175**  
**A-A arrow view** \* Change the orientation of the stay to change the direction that the stay opens.

## Divider dimensions

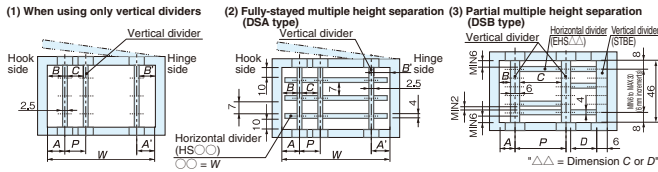

Notes:

- A : Distance from center of vertical divider to end face of link
- B : Gap between vertical divider and link
- P : Distance between the centers of neighboring vertical dividers
- C : Gap between neighboring vertical dividers
- D : Gap between neighboring vertical dividers when vertical dividers/dividers for both ends are installed

Note: Make the gap between cables/hoses and the divider or link (d in the figure to right) to whichever of the following two values is larger: 2 mm or greater or the outer diameter of the cable or hose x 0.1.

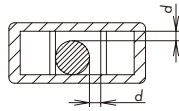

Vertical divider (fastening method)	Inner width W (mm)	A (mm)	A' (mm)	B (mm)	B' (mm)	P (mm)	C (mm)	D (mm)
STAS (sliding installation)	Common for all widths	min 7.25	min 5	min 6	min 3.75	min 10	min 7.5	
STAL (fixable installation)	75	9.5 to 44.5	Same as A	8.25 to 43.25	Same as B	14 to 42	7 mm increments to 39.5	7 mm increments
	100	11.5 to 46.5		10.25 to 45.25				7 mm increments
	125	10 to 45		8.75 to 43.75				7 mm increments
	150	12 to 47		10.75 to 45.75				7 mm increments
STBL (fixable installation)	75	min 9.5	7 mm increments	min 6.5	7 mm increments	28 to 56	7 mm increments to 50	21.5 to 49.5
	100	min 11.5		min 8.5				23.5 to 51.5
	125	min 10		min 7				22 to 50
	150	min 12		min 9				24 to 52
	175	min 10.5	min 7.5	22.5 to 50.5	7 mm increments			

Note: A' and B' are the hinge side.

## Dimension drawings

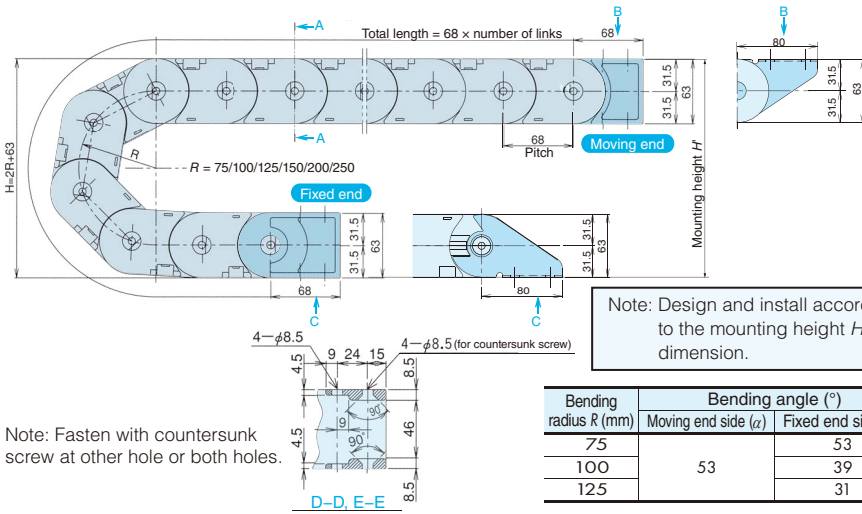

Note: Fasten with countersunk screw at other hole or both holes.

Note: Design and install according to the mounting height H' dimension.

Bending radius R (mm)	Bending angle (°)	
	Moving end side (α)	Fixed end side (β)
75		53
100	53	39
125		31

Bending radius R (mm)	Mounting height H' (mm)
75	223 to 243
100	273 to 293
125	323 to 343
150	373 to 393
200	473 to 493
250	573 to 593

Note: The bracket (FU/MU) has mounting holes for two vertical directions.

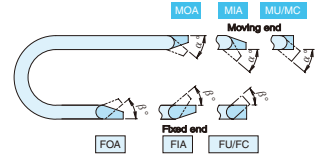

Bending radius R (mm)	Bending angle (°)	
	Moving end side (α)	Fixed end side (β)
150		26
200	53	19
250		15

## Bracket variants and dimensions

	Bracket (FU/MU)			Outside mounting			Inside mounting			Flange mounting		
	MU	MOA	MIA	MC	FU	FOA	FIA	FC				
Moving end bracket												
Barrow view												
Fixed end bracket												
C arrow view												
Inner width W (mm)	A (mm)	B (mm)	C (mm)	A (mm)	B (mm)	C (mm)	A (mm)	B (mm)	C (mm)			
75	53	97	89	53	85	89	117	153	157			
100	78	122	114	78	110	114	142	178	182			
125	103	147	139	103	135	139	167	203	207			
150	128	172	164	128	160	164	192	228	232			
175	153	197	189	153	185	189	217	253	257			



### Basic specifications

Maximum travel speed (m/min)		300 *1
Operating temperature range (°C)		-40 to 80
Materials	Link	Engineering plastic (black)
	Bracket (FU/MU)	Engineering plastic (black)
	Bracket	Steel (Trivalent chromate plating)
	Vertical divider	Engineering plastic (black)
	Horizontal divider	For DSA type (HS)
For DSB type (EHS)		Engineering plastic (black) + aluminum
Standard length (No. of links)		50

Notes: ★ 1. 150 m/min for support roller arrangement.  
2. Cannot be used in acidic or alkaline environments.

### Load diagram

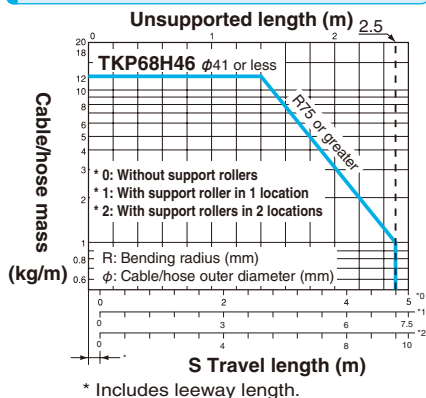

Note: Use the gliding arrangement (page 127) if capacity is exceeded.

### Calculating no. of links

$$\text{Number of links} = \frac{S}{2} + \pi R + 2K$$

Note: When fixed end is at the center of the travel length. Always round up the value after calculating.

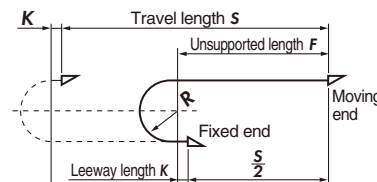

S: Travel length (mm)  
R: Bending radius (mm)  
P: Pitch = 68 mm  
K: Leeway length = 68 mm or greater

### Model number

**TKP68H46 - (1) W (2) R (3) + (4) L - (5) - (6)**

(1) Opening options		(2) Inner width	(3) Bending radius	(4) Number of links	(5) Fixed end	(6) Moving end
30	Outside openable stay	75	75		FU	MU
40	Inside openable stay	100	100		FOA	MOA
		125	125		FIA	MIA
		150	150		FC	MC
		175	200			
			250			

Notes: 1. Steel brackets (excluding FU and MU) and vertical dividers are common parts regardless of the inner width.  
2. Install dividers every 2 links.  
3. Stays, steel brackets, and dividers are delivered uninstalled. (For the FU and MU, these parts are delivered installed.)  
4. Refer to page 131 for model number for the gliding arrangement.

#### ■ Divider

Method	Type	Model number	
DSA Type	Vertical divider	STAS sliding installation	TKP68H46-STAS
		STAL fixable installation	TKP68H46-STAL
	Horizontal divider	TKP68H46-HS (Dimension W) W = 75/100/125/150/175	
DSB Type	Vertical divider	STBL fixable installation	TKP68H46-STBL
		STBE divider for both ends	TKP68H46-STBE
	Horizontal divider with end adapters	TKP68H46-EHS△△ △△ = Dimension C or D of divider dimensions	

#### ■ Vertical divider

Model number	For cable carrier model number
TKP68H46-STAS	TKP68H46-30/40W■■■R■■
TKP68H46-STAL	
TKP68H46-STBL	
TKP68H46-STBE	

#### ■ Horizontal divider

Model number	For cable carrier model number
TKP68H46-HS75	TKP68H46-30/40W75R■■
TKP68H46-HS100	TKP68H46-30/40W100R■■
TKP68H46-HS125	TKP68H46-30/40W125R■■
TKP68H46-HS150	TKP68H46-30/40W150R■■
TKP68H46-HS175	TKP68H46-30/40W175R■■

#### ■ Bracket (FU/MU)

Model number	For cable carrier model number
TKP68H46W75-MU	TKP68H46-30/40W75R■■
TKP68H46W75-FU	
TKP68H46W100-MU	TKP68H46-30/40W100R■■
TKP68H46W100-FU	
TKP68H46W125-MU	TKP68H46-30/40W125R■■
TKP68H46W125-FU	
TKP68H46W150-MU	TKP68H46-30/40W150R■■
TKP68H46W150-FU	
TKP68H46W175-MU	TKP68H46-30/40W175R■■
TKP68H46W175-FU	

#### ■ Horizontal divider with end adapters

Model number	For cable carrier model number
TKP68H46-EHS22	TKP68H46-30/40W■■■R■■ (Common for all widths)
TKP68H46-EHS29	
TKP68H46-EHS36	
TKP68H46-EHS43	
TKP68H46-EHS50	
TKP68H46-EHS21.5	TKP68H46-30/40W75R■■
TKP68H46-EHS28.5	
TKP68H46-EHS35.5	
TKP68H46-EHS42.5	
TKP68H46-EHS49.5	
TKP68H46-EHS23.5	TKP68H46-30/40W100R■■
TKP68H46-EHS30.5	
TKP68H46-EHS37.5	
TKP68H46-EHS44.5	
TKP68H46-EHS51.5	
TKP68H46-EHS24	TKP68H46-30/40W150R■■
TKP68H46-EHS31	
TKP68H46-EHS38	
TKP68H46-EHS45	
TKP68H46-EHS52	
TKP68H46-EHS22.5	TKP68H46-30/40W175R■■
TKP68H46-EHS29.5	
TKP68H46-EHS36.5	
TKP68H46-EHS43.5	
TKP68H46-EHS50.5	

#### ■ Steel bracket

Model number	For cable carrier model number
TKP68H46-MOA	TKP68H46-30/40W■■■R■■
TKP68H46-MIA	
TKP68H46-MC	
TKP68H46-FOA	TKP68H46-30/40W■■■R■■
TKP68H46-FIA	
TKP68H46-FC	

See page 15 for ordering information

See page 144 for product mass

# TKP90H50

## Structure

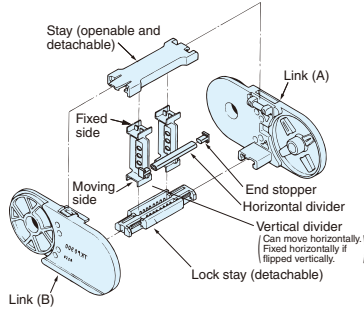

## Cross-section dimensions

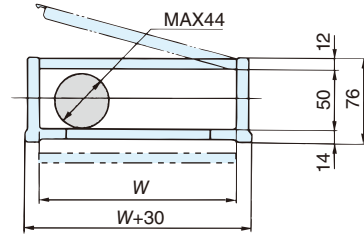

W = 100, 150, 200

A-A arrow view

## Divider dimensions

(1) When using only vertical dividers (2) Fully-stayed multiple height separation (DSA type)

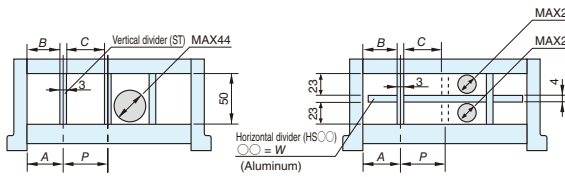

(3) Partial multiple height separation (DSB type)

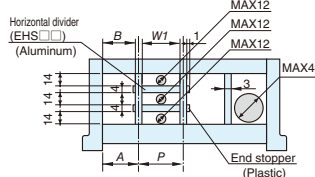

Vertical divider (fastening method)



Note: For the sliding installation, position the protrusion on the stay side. For the fixable installation, position the protrusion on the lock stay side.

Protrusion

Note: Make the gap between cables/hoses and the divider or link (d in the figure to right) to whichever of the following two values is larger: 2 mm or greater or the outer diameter of the cable or hose x 0.1.

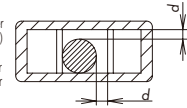

Vertical divider (fastening method)	Inner width W (mm)	A (mm)	B (mm)	P (mm)	C (mm)	W1 (mm)
ST (sliding installation)	Common for all widths	35 to 40	33.5 to 38.5	20 to 115	17 to 112	17 to 112 (adjustable in 1 mm increments)
ST (fixable installation)	100	min 35 5 mm increments	min 33.5 3 mm increments	20 to 30 5 mm increments	17 to 27 5 mm increments	17 to 27 5 mm increments
	150			20 to 80 5 mm increments	17 to 77 5 mm increments	17 to 77 5 mm increments
	200			20 to 112 5 mm increments	17 to 112 5 mm increments	17 to 112 5 mm increments

### Notes:

- A : Distance from center of vertical divider to end face of link
- B : Gap between vertical divider and link
- P : Distance between the centers of neighboring vertical dividers
- C : Gap between neighboring vertical dividers

Notes: 1. The maximum values for gaps A and P are applied when using horizontal dividers.  
2. The divider can slide between W-70. The fastening pitch of fixable dividers is 5 mm increments. However, the pitch of neighboring dividers is 20 mm or greater.

## Dimension drawings

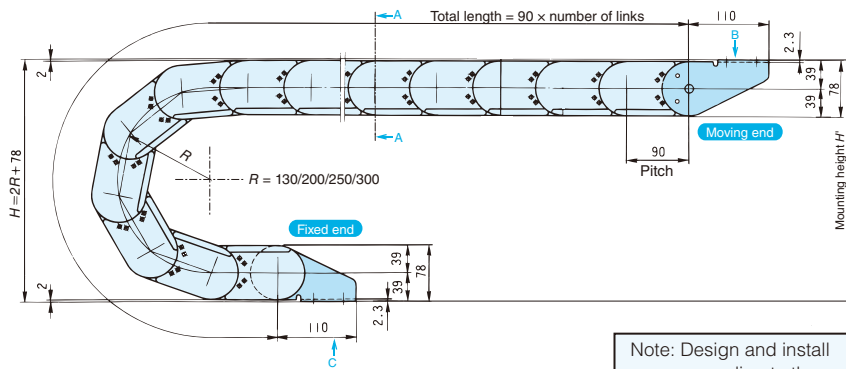

Note: Design and install according to the mounting height H dimension.

Bending radius R (mm)	Mounting height H' (mm)
130	348 to 368
200	488 to 508
250	588 to 608
300	688 to 708

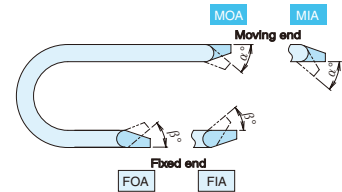

Bending radius R (mm)	Bending angle (°)	
	Moving end side (α)	Fixed end side (β)
130	37	47
200	23	
250	18	
300	14	

## Steel bracket variants and dimensions

Inner width W (mm)	Outside mounting		Inside mounting	
	Moving end bracket (MOA)	Fixed end bracket (FOA)	Moving end bracket (MIA)	Fixed end bracket (FIA)
100	A: 71, B: 107	C: 122	A: 71, B: 107	C: 122
150	A: 121, B: 157	C: 172	A: 121, B: 157	C: 172
200	A: 171, B: 207	C: 222	A: 171, B: 207	C: 222

**Basic specifications**

Maximum travel speed (m/min)	300 *1	
Operating temperature range (°C)	-40 to 80	
Materials	Link	Engineering plastic (black)
	Bracket	Steel (Trivalent chromate plating)
	Vertical divider	Engineering plastic (black)
	Horizontal divider	For DSA type (HS)
For DSB type (EHS)		Engineering plastic (black) + aluminum
Standard length (No. of links)	40	

Notes: ★ 1. 150 m/min for support roller arrangement.  
2. Cannot be used in acidic or alkaline environments.

**Load diagram**

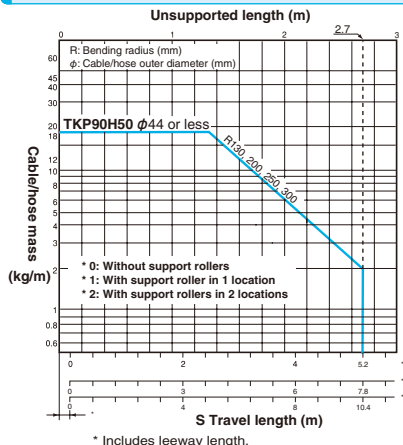

Note: Use the gliding arrangement (page 127) if capacity is exceeded.

**Calculating no. of links**

$$\text{Number of links} = \frac{\frac{S}{2} + \pi R + 2K}{P}$$

Note: When fixed end is at the center of the travel length. Always round up the value after calculating.

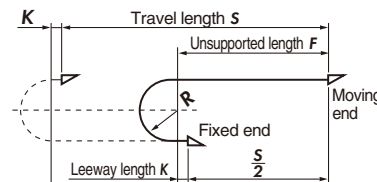

S: Travel length (mm)  
R: Bending radius (mm)  
P: Pitch = 90 mm  
K: Leeway length = 90 mm or greater

**Model number**

**TKP90H50W (1) R (2) + (3)L - (4) - (5)**

(1) Inner width	(2) Bending radius	(3) Number of links	(4) Fixed end	(5) Moving end
100	130		FOA	MOA
150	200		FIA	MIA
200	250			
	300			

Notes: 1. Steel brackets and vertical dividers are common parts regardless of the inner width.  
2. Install dividers every 2 links.  
3. The moving end bracket is delivered installed. The fixed end bracket and dividers are delivered uninstalled.  
4. Refer to page 131 for model number for the gliding arrangement.  
5. When ordering a circular travel arrangement, the made-to-order content will depend on the operating conditions. Contact a Tsubaki representative for further information.

**■ Divider**

Type	Model number	Part	Unit
(1) Vertical divider	TKP90H50-ST	1 vertical divider	K (pcs)
(2) Horizontal divider (For DSA type)	TKP90H50-HS (Dimension W) W = 100/150/200	1 horizontal divider	K (pcs)
(3) Horizontal divider with end stoppers (For DSB type)	TKP90H50-EHS (Dimension W1) W1 = 17 to 112: 1 mm increments	1 horizontal divider 2 end stoppers	K (pcs)

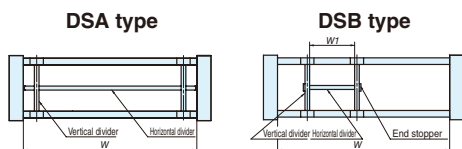

**■ Steel bracket**

Model number	For cable carrier model number
TKP90H50-MOA	TKP90H50W ■ ■ R ■ ■
TKP90H50-MIA	TKP90H50W ■ ■ R ■ ■
TKP90H50-FOA	TKP90H50W ■ ■ R ■ ■
TKP90H50-FIA	TKP90H50W ■ ■ R ■ ■

**■ Vertical divider**

Model number	For cable carrier model number
TKP90H50-ST	TKP90H50W ■ ■ R ■ ■

**■ Horizontal divider**

Model number	For cable carrier model number
TKP90H50-HS100	TKP90H50W100R ■ ■
TKP90H50-HS150	TKP90H50W150R ■ ■
TKP90H50-HS200	TKP90H50W200R ■ ■

**■ Horizontal divider with end stoppers**

Model number
TKP90H50-EHS □ □

□ □: Integer between 17 and 112

See page 15 for ordering information

See page 144 for product mass

# TKP91H56

(Patented)

## Structure

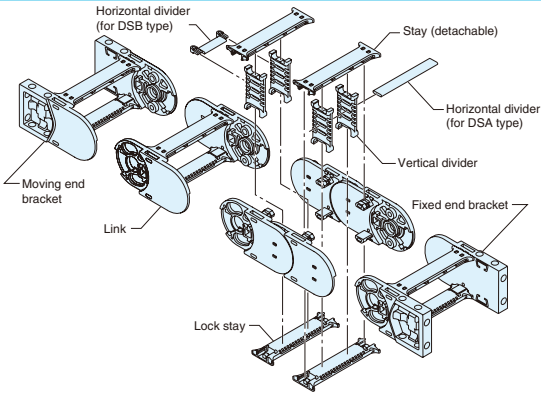

## Cross-section dimensions

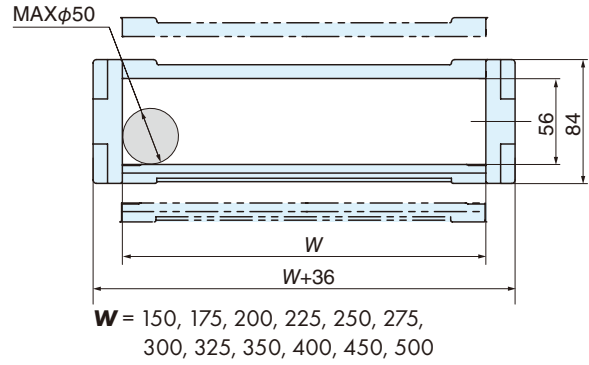

A-A arrow view

## Divider dimensions

(1) When using only vertical dividers

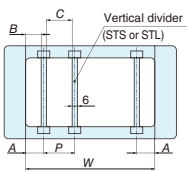

(2) Fully-stayed multiple height separation (DSA type)

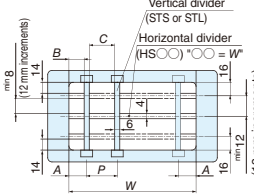

(3) Partial multiple height separation (DSB type)

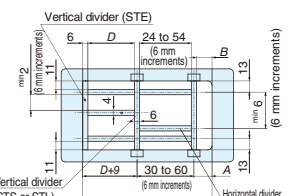

"ΔΔ" = Dimension C or "D"

Vertical divider (fastening method)	Inner width W (mm)	A (mm)	B (mm)	P (mm)	C (mm)	D (mm)
STS (sliding installation)	Common for all widths	20 to 40	17 to 37	14 to 100	8 to 94	
	150	27, 33, 39	24, 30, 36	18 to 96 (6 mm increments)	12 to 90 (6 mm increments)	24 to 54
	175	33.5, 39.5	30.5, 36.5			24.5 to 54.5
	200	31, 37	28, 34			22 to 52
	225	31.5, 37.5	28.5, 34.5			22.5 to 52.5
250	32, 38	29, 35	23 to 53			
STL (fixable installation)	275	32.5, 38.5	29.5, 35.5	18 to 96 (6 mm increments)	12 to 90 (6 mm increments)	23.5 to 53.5
	300	33, 39	30, 36			24 to 54
	325	33.5, 39.5	30.5, 36.5			24.5 to 54.5
	350	31, 37	28, 34			22 to 52
	400	32, 38	29, 35			23 to 53
	450	33, 39	30, 36			24 to 54
	500	31, 37	28, 34			22 to 52

Note: The maximum values for A, B, P, C, and D are applied when using horizontal dividers.

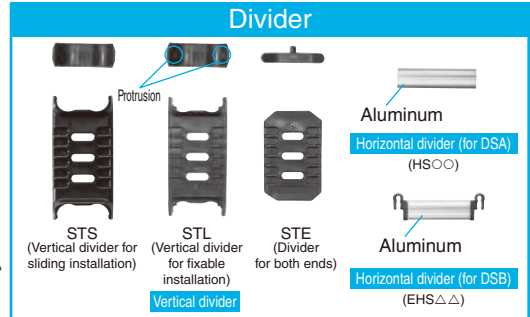

### Notes:

- A : Distance from center of vertical divider to end face of link
- B : Gap between vertical divider and link
- P : Distance between the centers of neighboring vertical dividers
- C : Gap between neighboring vertical dividers
- D : Gap between neighboring vertical dividers when vertical dividers/dividers for both ends are installed

Note: Make the gap between cables/hoses and the divider or link (d in the figure to right) to whichever of the following two values is larger: 2 mm or greater or the outer diameter of the cable or hose x 0.1.

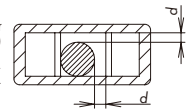

## Dimensions & brackets

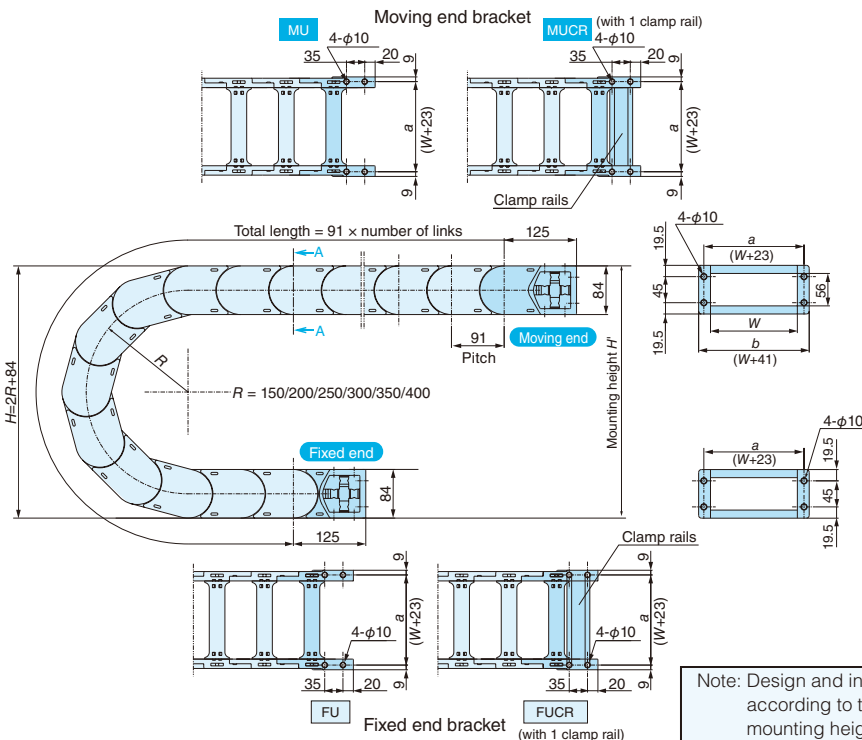

Bending radius R (mm)	Mounting height H' (mm)
150	394 to 414
200	494 to 514
250	594 to 614
300	694 to 714
350	794 to 814
400	894 to 914

W (mm)	a (mm)	b (mm)
150	173	191
175	198	216
200	223	241
225	248	266
250	273	291
275	298	316
300	323	341
325	348	366
350	373	391
400	423	441
450	473	491
500	523	541

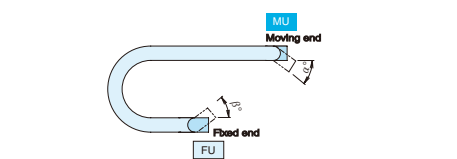

Bending radius R (mm)	Bending angle (°)	
	Moving end side (α)	Fixed end side (β)
150	35	35
200	26	
250	20	
300	17	
350	15	
400	13	

### Basic specifications

Maximum travel speed (m/min)		300 *1
Operating temperature range (°C)		-40 to 80
Materials	Link	Engineering plastic (black)
	Bracket	Engineering plastic (black) With steel bush
	Vertical divider	Engineering plastic (black)
	Horizontal divider	For DSA type (HS) For DSB type (EHS)
Standard length (No. of links)		R350 or less: 20 R400 : 10

Notes: ★ 1. 150 m/min for support roller arrangement.  
2. Cannot be used in acidic or alkaline environments.

### Load diagram

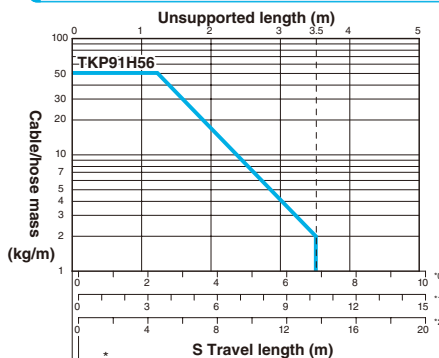

\* Includes leeway length.  
\* 0: Without support rollers  
\* 1: With support roller in 1 location  
\* 2: With support rollers in 2 locations

Note: Use the gliding arrangement (page 127) if capacity is exceeded.

### Calculating no. of links

$$\text{Number of links} = \frac{S}{2} + \pi R + 2K$$

Note: When fixed end is at the center of the travel length. Always round up the value after calculating.

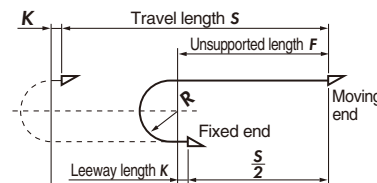

S: Travel length (mm)  
R: Bending radius (mm)  
P: Pitch = 91 mm  
K: Leeway length = 91 mm or greater

### Model number

**TKP91H56W (1) R (2) + (3) L - (4) - (5)**

(1) Inner width		(2) Bending radius	(3) Number of links	(4) Fixed end	(5) Moving end
150	300	150		FU	MU
175	325	200		FUCR	MUCR
200	350	250			
225	400	300			
250	450	350			
275	500	400			

Notes: 1. Dividers and clamp rails are delivered uninstalled.  
2. Refer to page 131 for model number for the gliding arrangement.

#### Divider

Type	Model number
Vertical divider (sliding installation)	TKP91H56-ST5
Vertical divider (fixable installation)	TKP91H56-STL
Vertical divider (for both ends)	TKP91H56-STE
Horizontal divider (for DSA type)	TKP91H56-HS○○
Horizontal divider (for DSB type)	TKP91H56-EHS△△

○○ = 150, 175, 200  
△△ = Dimension C or D of divider dimensions.

#### Vertical divider

Model number	For cable carrier model number
TKP91H56-ST5	TKP91H56W■■R■■
TKP91H56-STL	
TKP91H56-STE	

#### Horizontal divider

Model number	For cable carrier model number
TKP91H56-HS150	TKP91H56W150R■■
TKP91H56-HS175	TKP91H56W175R■■
TKP91H56-HS200	TKP91H56W200R■■

#### Bracket

Model number	For cable carrier model number
TKP91H56W150-MU	TKP91H56W150R■■
TKP91H56W150-FU	
TKP91H56W150-MUCR	
TKP91H56W150-FUCR	TKP91H56W175R■■
TKP91H56W175-MU	
TKP91H56W175-FU	
TKP91H56W175-MUCR	TKP91H56W200R■■
TKP91H56W175-FUCR	
TKP91H56W200-MU	
TKP91H56W200-FU	TKP91H56W225R■■
TKP91H56W200-MUCR	
TKP91H56W200-FUCR	
TKP91H56W225-MU	TKP91H56W225R■■
TKP91H56W225-FU	
TKP91H56W225-MUCR	
TKP91H56W225-FUCR	

#### Horizontal divider with end adapters

Model number	For cable carrier model number
TKP91H56-EHS24	TKP91H56W■■R■■ (Common for all widths)
TKP91H56-EHS30	
TKP91H56-EHS36	
TKP91H56-EHS42	
TKP91H56-EHS48	
TKP91H56-EHS54	
TKP91H56-EHS24.5	TKP91H56W■■R■■ (* For W = 175, 325)
TKP91H56-EHS30.5	
TKP91H56-EHS36.5	
TKP91H56-EHS42.5	
TKP91H56-EHS48.5	
TKP91H56-EHS54.5	
TKP91H56-EHS22	TKP91H56W■■R■■ (* For W = 200, 350, 500)
TKP91H56-EHS28	
TKP91H56-EHS34	
TKP91H56-EHS40	
TKP91H56-EHS46	
TKP91H56-EHS52	

#### Bracket

Model number	For cable carrier model number
TKP91H56W250-MU	TKP91H56W250R■■
TKP91H56W250-FU	
TKP91H56W250-MUCR	
TKP91H56W250-FUCR	TKP91H56W275R■■
TKP91H56W275-MU	
TKP91H56W275-FU	
TKP91H56W275-MUCR	TKP91H56W300R■■
TKP91H56W275-FUCR	
TKP91H56W300-MU	
TKP91H56W300-FU	TKP91H56W325R■■
TKP91H56W300-MUCR	
TKP91H56W300-FUCR	
TKP91H56W325-MU	TKP91H56W325R■■
TKP91H56W325-FU	
TKP91H56W325-MUCR	
TKP91H56W325-FUCR	

#### Horizontal divider with end adapters

Model number	For cable carrier model number
TKP91H56-EHS22.5	TKP91H56W■■R■■ (* For W = 225)
TKP91H56-EHS28.5	
TKP91H56-EHS34.5	
TKP91H56-EHS40.5	
TKP91H56-EHS46.5	
TKP91H56-EHS52.5	
TKP91H56-EHS23	TKP91H56W■■R■■ (* For W = 250, 400)
TKP91H56-EHS29	
TKP91H56-EHS35	
TKP91H56-EHS41	
TKP91H56-EHS47	
TKP91H56-EHS53	
TKP91H56-EHS23.5	TKP91H56W■■R■■ (* For W = 275)
TKP91H56-EHS29.5	
TKP91H56-EHS35.5	
TKP91H56-EHS41.5	
TKP91H56-EHS47.5	
TKP91H56-EHS53.5	

\* When used on vertical divider for both ends (STE).

# TKP91H80

(Patented)

## Structure

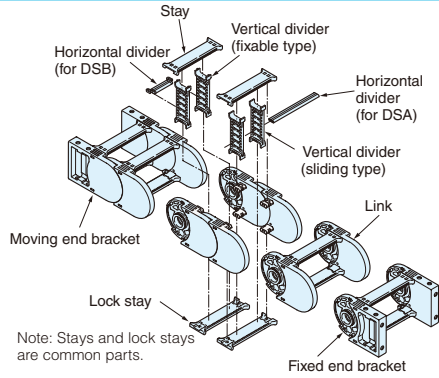

## Cross-section dimensions

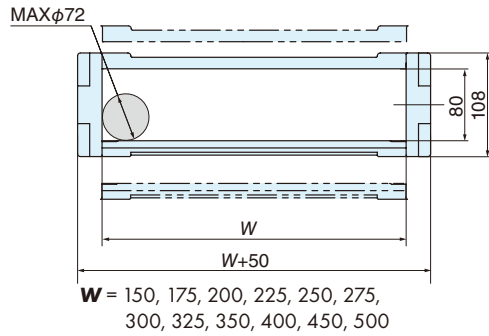

A-A arrow view

## Divider dimensions

(1) When using only vertical dividers

(2) Fully-stayed multiple height separation (DSA type)

(3) Partial multiple height separation (DSB type)

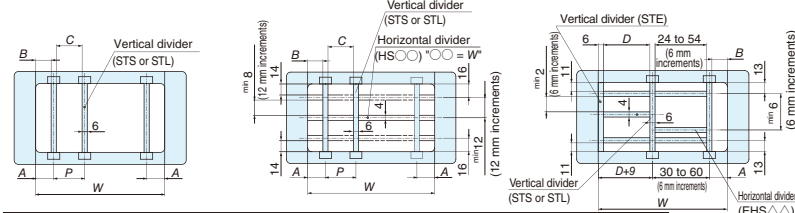

Vertical divider (fastening method)	Inner width W (mm)	A (mm)	B (mm)	P (mm)	C (mm)	D (mm)
STS (sliding installation)	Common for all widths	20 to 40	17 to 37	14 to 100	8 to 94	
	150	27, 33, 39	24, 30, 36	18 to 96 (6 mm increments)	12 to 90 (6 mm increments)	24 to 54
	175	33.5, 39.5	30.5, 36.5			24.5 to 54.5
	200	31, 37	28, 34			22 to 52
	225	31.5, 37.5	28.5, 34.5			22.5 to 52.5
250	32, 38	29, 35	23 to 53			
STL (fixable installation)	275	32.5, 38.5	29.5, 35.5	18 to 96 (6 mm increments)	12 to 90 (6 mm increments)	23.5 to 53.5
	300	33, 39	30, 36			24 to 54
	325	33.5, 39.5	30.5, 36.5			24.5 to 54.5
	350	31, 37	28, 34			22 to 52
	400	32, 38	29, 35			23 to 53
	450	33, 39	30, 36			24 to 54
	500	31, 37	28, 34			22 to 52

Note: The maximum values for A, B, P, C, and D are applied when using horizontal dividers.

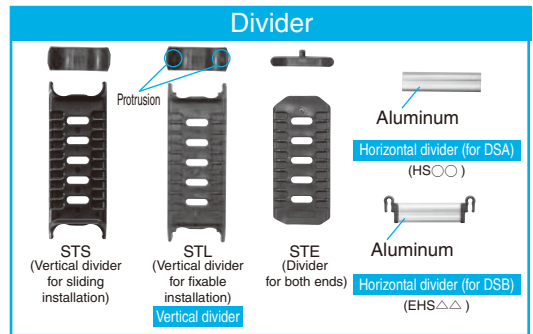

Notes:

- A : Distance from center of vertical divider to end face of link
- B : Gap between vertical divider and link
- P : Distance between the centers of neighboring vertical dividers
- C : Gap between neighboring vertical dividers
- D : Gap between neighboring vertical dividers when vertical dividers/dividers for both ends are installed

Note: Make the gap between cables/hoses and the divider or link (d in the figure to right) to whichever of the following two values is larger: 2 mm or greater or the outer diameter of the cable or hose x 0.1.

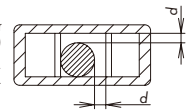

## Dimensions & brackets

Moving end bracket

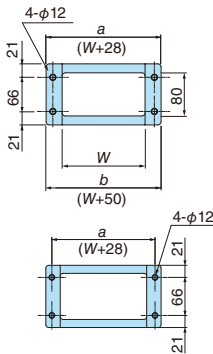
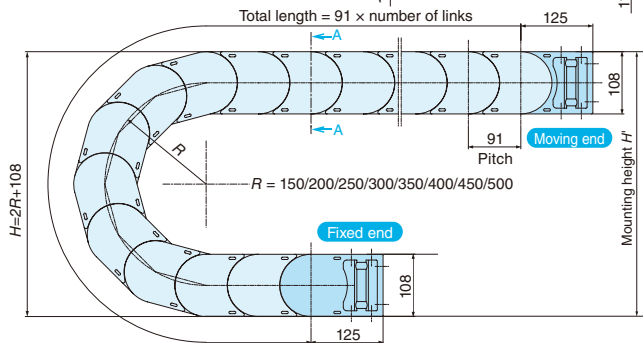
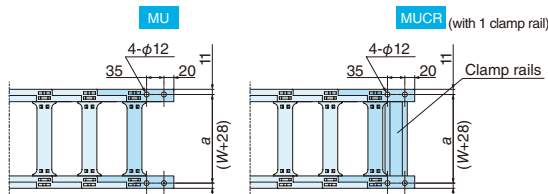

Note: Design and install according to the mounting height H dimension.

Bending radius R (mm)	Mounting height H' (mm)
150	418 to 438
200	518 to 538
250	618 to 638
300	718 to 738
350	818 to 838
400	918 to 938
450	1018 to 1038
500	1118 to 1138

W (mm)	a (mm)	b (mm)
150	178	200
175	203	225
200	228	250
225	253	275
250	278	300
275	303	325
300	328	350
325	353	375
350	378	400
400	428	450
450	478	500
500	528	550

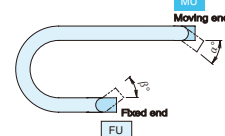

Bending radius R (mm)	Bending angle (°)	
	Moving end side (α)	Fixed end side (β)
150	35	35
200	26	
250	20	
300	17	
350	15	
400	13	
450	11	
500	10	

### Basic specifications

Maximum travel speed (m/min)		300 *1
Operating temperature range (°C)		-40 to 80
Materials	Link	Engineering plastic (black)
	Bracket	Engineering plastic (black) With steel bush
	Vertical divider	Engineering plastic (black)
	Horizontal divider	For DSA type (HS) For DSB type (EHS)
Standard length (No. of links)		R350 or less: 20 R400 to R500: 10

Notes: ★1. 150 m/min for support roller arrangement.  
2. Cannot be used in acidic or alkaline environments.

### Load diagram

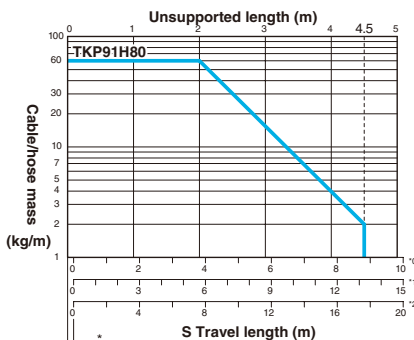

\* Includes leeway length.  
\* 0: Without support rollers  
\* 1: With support roller in 1 location  
\* 2: With support rollers in 2 locations

Note: Use the gliding arrangement (page 127) if capacity is exceeded.

### Calculating no. of links

$$\text{Number of links} = \frac{\frac{S}{2} + \pi R + 2K}{P}$$

Note: When fixed end is at the center of the travel length. Always round up the value after calculating.

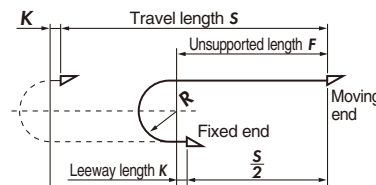

S: Travel length (mm)  
R: Bending radius (mm)  
P: Pitch = 91 mm  
K: Leeway length = 91 mm or greater

### Model number

**TKP91H80W (1) R (2) + (3) L - (4) - (5)**

(1) Inner width		(2) Bending radius		(3) Number of links	(4) Fixed end	(5) Moving end
150	300	150	350		FU	MU
175	325	200	400		FUCR	MUCR
200	350	250	450			
225	400	300	500			
250	450					
275	500					

Notes: 1. Dividers and clamp rails are delivered uninstalled.  
2. Refer to page 131 for model number for the gliding arrangement.

#### Divider

Type	Model number
Vertical divider (sliding installation)	TKP91H80-STS
Vertical divider (fixable installation)	TKP91H80-STL
Vertical divider (for both ends)	TKP91H80-STE
Horizontal divider (for DSA type)	TKP91H80-HS○○
Horizontal divider (for DSB type)	TKP91H80-EHS△△

○○ = 150, 175, 200  
△△ = Dimension C or D of divider dimensions.

#### Vertical divider

Model number	For cable carrier model number
TKP91H80-STS	TKP91H80W■■R■■
TKP91H80-STL	
TKP91H80-STE	

#### Horizontal divider

Model number	For cable carrier model number
TKP91H80-HS150	TKP91H80W150R■■
TKP91H80-HS175	TKP91H80W175R■■
TKP91H80-HS200	TKP91H80W200R■■

#### Bracket

Model number	For cable carrier model number
TKP91H80W150-MU	TKP91H80W150R■■
TKP91H80W150-FU	
TKP91H80W150-MUCR	
TKP91H80W150-FUCR	
TKP91H80W175-MU	TKP91H80W175R■■
TKP91H80W175-FU	
TKP91H80W175-MUCR	
TKP91H80W175-FUCR	
TKP91H80W200-MU	TKP91H80W200R■■
TKP91H80W200-FU	
TKP91H80W200-MUCR	
TKP91H80W200-FUCR	
TKP91H80W225-MU	TKP91H80W225R■■
TKP91H80W225-FU	
TKP91H80W225-MUCR	
TKP91H80W225-FUCR	

#### Horizontal divider with end adapters

Model number	For cable carrier model number
TKP91H80-EHS24	TKP91H80W■■R■■ (Common for all widths)
TKP91H80-EHS30	
TKP91H80-EHS36	
TKP91H80-EHS42	
TKP91H80-EHS48	
TKP91H80-EHS54	TKP91H80W■■R■■ (* For W = 175,325)
TKP91H80-EHS24.5	
TKP91H80-EHS30.5	
TKP91H80-EHS36.5	
TKP91H80-EHS42.5	
TKP91H80-EHS48.5	TKP91H80W■■R■■ (* For W = 200,350,500)
TKP91H80-EHS54.5	
TKP91H80-EHS22	
TKP91H80-EHS28	
TKP91H80-EHS34	
TKP91H80-EHS40	TKP91H80W■■R■■ (* For W = 200,350,500)
TKP91H80-EHS46	
TKP91H80-EHS52	

#### Bracket

Model number	For cable carrier model number
TKP91H80W250-MU	TKP91H80W250R■■
TKP91H80W250-FU	
TKP91H80W250-MUCR	
TKP91H80W250-FUCR	
TKP91H80W275-MU	TKP91H80W275R■■
TKP91H80W275-FU	
TKP91H80W275-MUCR	
TKP91H80W275-FUCR	
TKP91H80W300-MU	TKP91H80W300R■■
TKP91H80W300-FU	
TKP91H80W300-MUCR	
TKP91H80W300-FUCR	
TKP91H80W325-MU	TKP91H80W325R■■
TKP91H80W325-FU	
TKP91H80W325-MUCR	
TKP91H80W325-FUCR	

#### Horizontal divider with end adapters

Model number	For cable carrier model number
TKP91H80-EHS22.5	TKP91H80W■■R■■ (* For W = 225)
TKP91H80-EHS28.5	
TKP91H80-EHS34.5	
TKP91H80-EHS40.5	
TKP91H80-EHS46.5	
TKP91H80-EHS52.5	TKP91H80W■■R■■ (* For W = 250,400)
TKP91H80-EHS23	
TKP91H80-EHS29	
TKP91H80-EHS35	
TKP91H80-EHS41	
TKP91H80-EHS47	TKP91H80W■■R■■ (* For W = 275)
TKP91H80-EHS53	
TKP91H80-EHS59	
TKP91H80-EHS65	
TKP91H80-EHS71	

\* When used on vertical divider for both ends (STE).

#### Bracket

Model number	For cable carrier model number
TKP91H80W350-MU	TKP91H80W350R■■
TKP91H80W350-FU	
TKP91H80W350-MUCR	
TKP91H80W350-FUCR	
TKP91H80W400-MU	TKP91H80W400R■■
TKP91H80W400-FU	
TKP91H80W400-MUCR	
TKP91H80W400-FUCR	
TKP91H80W450-MU	TKP91H80W450R■■
TKP91H80W450-FU	
TKP91H80W450-MUCR	
TKP91H80W450-FUCR	
TKP91H80W500-MU	TKP91H80W500R■■
TKP91H80W500-FU	
TKP91H80W500-MUCR	
TKP91H80W500-FUCR	

# TKP125H74

## Structure

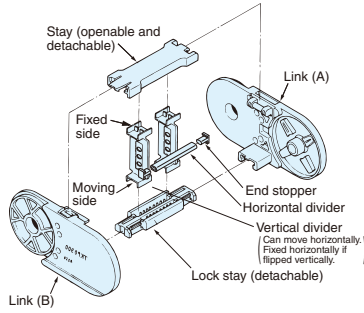

## Cross-section dimensions

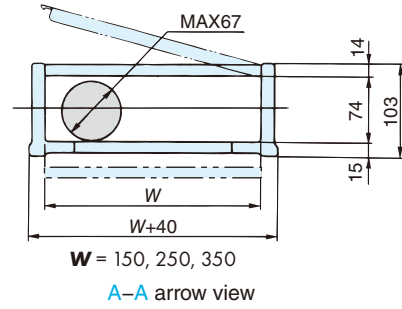

## Divider dimensions

(1) When using only vertical dividers

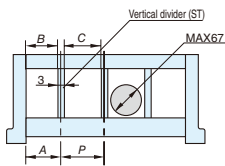

(2) Fully-stayed multiple height separation (DSA type)

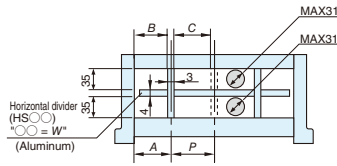

(3) Partial multiple height separation (DSB type)

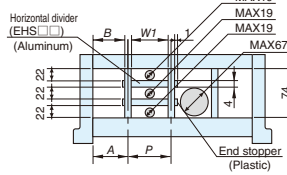

Vertical divider (fastening method)



Note: For the sliding installation, position the protrusion on the stay side. For the fixable installation, position the protrusion on the lock stay side.

Vertical divider (fastening method)	Inner width W (mm)	A (mm)	B (mm)	P (mm)	C (mm)	W1 (mm)
ST (sliding installation)	Common for all widths	min40	min38.5	25 to 100	22 to 97	22 to 97
ST (fixable installation)	150	min40	min38.5	25 to 70	22 to 67	22 to 67
	250			25 to 100	22 to 97	22 to 97
	350			25 to 100	22 to 97	22 to 97

### Notes:

- A : Distance from center of vertical divider to end face of link
- B : Gap between vertical divider and link
- P : Distance between the centers of neighboring vertical dividers
- C : Gap between neighboring vertical dividers

Note: Make the gap between cables/hoses and the divider or link (d in the figure to right) to whichever of the following two values is larger: 2 mm or greater or the outer diameter of the cable or hose x 0.1.

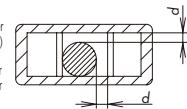

Note: The maximum values for gaps A and P are applied when using horizontal dividers.

## Dimension drawings

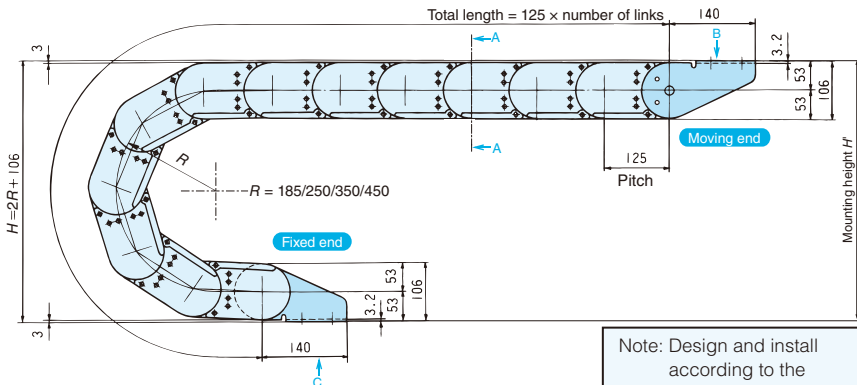

Note: Design and install according to the mounting height H' dimension.

Bending radius R (mm)	Mounting height H' (mm)
185	486 to 506
250	616 to 636
350	816 to 836
450	1016 to 1036

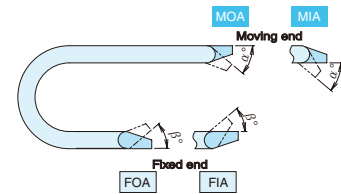

Bending radius R (mm)	Bending angle (°)	
	Moving end side (α)	Fixed end side (β)
185	27	38
250	16	
350	8	
450	3	

## Steel bracket variants and dimensions

Inner width W (mm)	Outside mounting			Inside mounting		
	MOA (Moving end bracket)	FOA (Fixed end bracket)	MIA (Moving end bracket)	FIA (Fixed end bracket)		
150	120	158	180	120	158	180
250	220	258	280	220	258	280
350	320	358	380	320	358	380



### Basic specifications

Maximum travel speed (m/min)		300 *1
Operating temperature range (°C)		-40 to 80
Materials	Link	Engineering plastic (black)
	Bracket	Steel (Trivalent chromate plating)
	Vertical divider	Engineering plastic (black)
	Horizontal divider	For DSA type (HS) For DSB type (EHS)
Standard length (No. of links)		R250 or less: 30 R350 or more: 18

Notes: ★1. 150 m/min for support roller arrangement.  
2. Cannot be used in acidic or alkaline environments.

### Load diagram

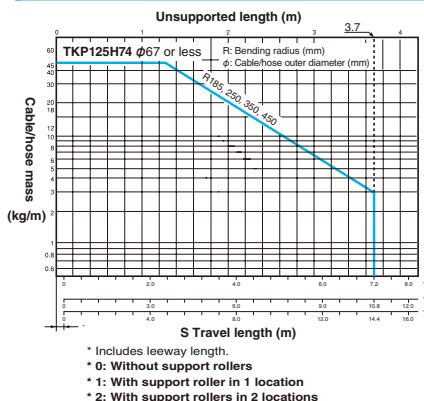

Note: Use the gliding arrangement (page 127) if capacity is exceeded.

### Calculating no. of links

$$\text{Number of links} = \frac{S}{2} + \pi R + 2K$$

Note: When fixed end is at the center of the travel length. Always round up the value after calculating.

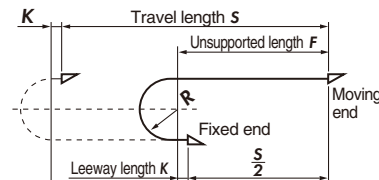

S: Travel length (mm)  
 R: Bending radius (mm)  
 P: Pitch = 125 mm  
 K: Leeway length = 125 mm or greater

### Model number

**TKP125H74W (1) R (2) + (3)L - (4) - (5)**

(1) Inner width	(2) Bending radius	(3) Number of links	(4) Fixed end	(5) Moving end
150	185		FOA	MOA
250	250		FIA	MIA
350	350			
	450			

Notes: 1. Steel brackets and vertical dividers are common parts regardless of the inner width.  
 2. Install dividers every 2 links.  
 3. The moving end bracket is delivered installed. The fixed end bracket and dividers are delivered uninstalled.  
 4. Refer to page 131 for model number for the gliding arrangement.  
 5. When ordering a circular travel arrangement, the made-to-order content will depend on the operating conditions. Contact a Tsubaki representative for further information.

#### ■ Divider

Type	Model number	Part	Unit
(1) Vertical divider	TKP125H74-ST	1 vertical divider	K (pcs)
(2) Horizontal divider (For DSA type)	TKP125H74-HS (Dimension W) W = 150/250	1 horizontal divider	K (pcs)
(3) Horizontal divider with end stoppers (For DSB type)	TKP125H74-EHS (Dimension W1) W1 = 22 to 97: 1 mm increments	1 horizontal divider 2 end stoppers	K (pcs)

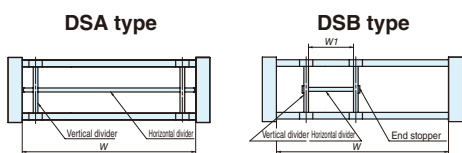

#### ■ Vertical divider

Model number	For cable carrier model number
TKP125H74-ST	TKP125H74W ■■ R ■■

#### ■ Horizontal divider

Model number	For cable carrier model number
TKP125H74-HS150	TKP125H74W150R ■■
TKP125H74-HS250	TKP125H74W250R ■■

#### ■ Horizontal divider with end stoppers

Model number
TKP125H74-EHS □ □

□ □: Integer between 22 and 97

#### ■ Steel bracket

Model number	For cable carrier model number
TKP125H74-MOA	TKP125H74W ■■ R ■■
TKP125H74-MIA	
TKP125H74-FOA	TKP125H74W ■■ R ■■
TKP125H74-FIA	

See page 15 for ordering information

See page 145 for product mass

# TKP Series MW Type (Low Friction/Anti-Wear Series) TSUBAKI ECO LINK

The TKP Series MW Type is a high-functionality cable carrier that offers better protection of cables and hoses while improving cleanliness by using special materials with high slidability.

## Features

### Better protection of cables and hoses and improved cleanliness

The TKP Series MW Type is effective in preventing jacket abrasion of cables and hoses. Compared to the standard types, the MW Type reduces the amount of wear on cables and hoses from sliding with the cable carrier. Cables and hoses are protected gently even in extreme operating conditions with high operating frequencies.

	MW Type	Standard type
Protection for cables/hoses	⊙	○
Cleanliness	⊙	○
Handling	⊙	⊙
Load (graph)	○	⊙
Price	○	⊙
Lead time	○	⊙

⊙: Superior ○: Normal

## Lineup

Model	Inner width (mm)		Bending radius (mm)	Pitch (mm)	Leeway length* (mm)	Cable/hose maximum outer diameter (mm)	Cable/hose maximum mass (kg/m)	Maximum unsupported length* (m)	Maximum travel length* (m)	Standard length (No. of links)
	Inner height (mm)	Inner width (mm)								
TKP13H10	10	10	18/28/37	13	26	8	0.4	0.55 (R18 = 0.42)	1.0 (R18 = 0.8)	77
		20								
TKP18H14	14	15	28/37/50	18	36	12	1	0.72 (R28 = 0.63)	1.4 (R28 = 1.2)	55
		40								
TKP25H15	15	15	28/37/50	25	38	13	1	0.72 (R28 = 0.63)	1.4 (R28 = 1.2)	40
		20								
		30								
TKP35H22	22	13	37/50/75/100	35	53	19 (W13 = 11)	2	R37/50 = 0.96 (R75 or more = 1.12)	2.2 (R37/R50 = 1.8)	25
		25								
		38								
		50								
TKP35H32	32	16	60/75 100/125	35	53	14	2	R60 = 0.88 R75/100/125 = 0.96	1.8 (R60 = 1.6)	25
		63								
TKP45H25	25	38	50/75/95 125/150 200	45	68	22	4.5	R50 = 1.12 R75/95 = 1.32 R125/150/200 = 1.40	R50 = 2.3 R75/95 = 2.5 R125/150/200 = 2.6	20
		58								
		78								
		103								

\*: Be aware that this differs from the standard types.

## Basic specifications (common to each model)

Maximum travel speed (m/min)	300 *12
Operating temperature range (°C)	-20 to 80
Materials	Link: Engineering plastic (gray)
	Bracket: Engineering plastic (gray) * Only TKP45H25 is steel (Trivalent chromate plating)

- Notes: 1. The overall dimensions and structure are the same as the standard types. Refer to pages 35 to 50.  
 2. The leeway length for the MW Type differs from the standard types, so the number of required links will also differ. Refer to the leeway lengths in the table above.  
 3. If considering usage in a vertical installation, etc., with a travel length that exceeds the load diagram for the standard installation (\*), contact a Tsubaki representative. (\* Refer to page 123.)  
 4. Contact a Tsubaki representative for usage in a gliding arrangement or circular travel arrangement.  
 5. The TKP45H25 steel bracket is a common part with the steel standard bracket.  
 6. Be aware that the TKP45H25 single-part steel bracket cannot be used.  
 7. Be aware that TKP45H25 horizontal divider with end stoppers (DSB type) cannot be used.  
 8. Do not mix MW Type and standard type cable carriers. Install problems may occur, which can cause improper bending and links to fall off.  
 9. Do not use MW Type vertical and horizontal dividers on standard type cable carriers.  
 10. Aluminum horizontal dividers (TKP45H25-HS58, etc.) for standard type cable carriers have slightly different dimensions than aluminum horizontal dividers (TKP45H25M-HS58, etc.) for MW Type cable carriers.  
 Be aware that standard type horizontal dividers may not be installed to MW Type chain links.  
 11. Cannot be used in acidic or alkaline environments.  
 \*12. 150 m/min for support roller arrangement.

## Load diagram

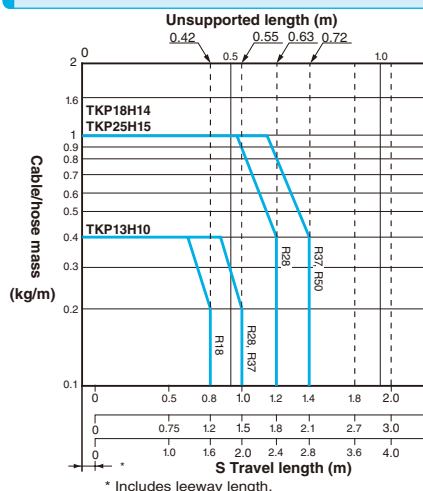

\*0: Without support rollers  
 \*1: With support roller in 1 location  
 \*2: With support rollers in 2 locations

\* Includes leeway length.

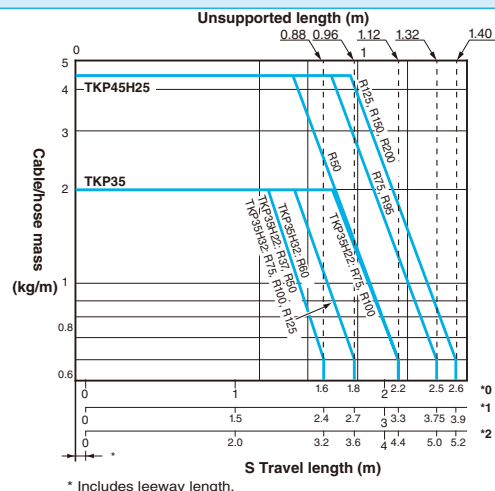

Model number

TKP13H10 MW Type

TKP13H10 - (1) W (2) R (3) M + (4) L - (5) - (6)

(1) Opening options	(2) Inner width	(3) Bending radius	(4) Number of links	(5) Fixed end	(6) Moving end
30 Outside openable stay	10 20	18 28 37		FO FI	MO MI

Bracket

Model number	For cable carrier model number
TKP13H10W10M-MO	TKP13H10-30W10R■M
TKP13H10W10M-MI	
TKP13H10W10M-FO	
TKP13H10W10M-FI	
TKP13H10W20M-MO	TKP13H10-30W20R■M
TKP13H10W20M-MI	
TKP13H10W20M-FO	
TKP13H10W20M-FI	

TKP18H14 MW Type

TKP18H14 - (1) W (2) R (3) M + (4) L - (5) - (6)

(1) Opening options	(2) Inner width	(3) Bending radius	(4) Number of links	(5) Fixed end	(6) Moving end
30 Outside openable stay	15 40	28 37 50		FO FI	MO MI

Bracket

Model number	For cable carrier model number
TKP18H14W15M-MO	TKP18H14-30W15R■M
TKP18H14W15M-MI	
TKP18H14W15M-FO	
TKP18H14W15M-FI	
TKP18H14W40M-MO	TKP18H14-30W40R■M
TKP18H14W40M-MI	
TKP18H14W40M-FO	
TKP18H14W40M-FI	

TKP25H15 MW Type

TKP25H15 - (1) W (2) R (3) M + (4) L - (5) - (6)

(1) Opening options	(2) Inner width	(3) Bending radius	(4) Number of links	(5) Fixed end	(6) Moving end
30 Outside openable stay	15 20 30	28 37 50		FO FI	MO MI

Bracket

Model number	For cable carrier model number
TKP25H15W15M-MO	TKP25H15-30W15R■M
TKP25H15W15M-MI	
TKP25H15W15M-FO	
TKP25H15W15M-FI	
TKP25H15W20M-MO	TKP25H15-30W20R■M
TKP25H15W20M-MI	
TKP25H15W20M-FO	
TKP25H15W20M-FI	
TKP25H15W30M-MO	TKP25H15-30W30R■M
TKP25H15W30M-MI	
TKP25H15W30M-FO	
TKP25H15W30M-FI	

TKP35H22/TKP35H32 MW Type

TKP35H22 - (1) W (2) R (3) M + (4) L - (5) - (6)

(1) Opening options	(2) Inner width	(3) Bending radius	(4) Number of links	(5) Fixed end	(6) Moving end
30 Outside openable stay	13 50	37 75		FO	MO
40 Inside openable stay	25 63	50 100		FI	MI
	38				

TKP35H32 - (1) W (2) R (3) M + (4) L - (5) - (6)

(1) Opening options	(2) Inner width	(3) Bending radius	(4) Number of links	(5) Fixed end	(6) Moving end
30 Outside openable stay	16	60 100		FO	MO
		75 125			MI

Vertical divider

Model number	For cable carrier model number
TKP35H22M-ST	TKP35H22-30/40W■R■M

Horizontal divider

Model number	For cable carrier model number
TKP35H22M-HS38	TKP35H22-30/40W38R■M
TKP35H22M-HS50	TKP35H22-30/40W50R■M
TKP35H22M-HS63	TKP35H22-30/40W63R■M

Bracket

Model number	For cable carrier model number
TKP35H22W13M-MO	TKP35H22-30/40W13R■M
TKP35H22W13M-MI	
TKP35H22W13M-FO	
TKP35H22W13M-FI	
TKP35H22W25M-MO	TKP35H22-30/40W25R■M
TKP35H22W25M-MI	
TKP35H22W25M-FO	
TKP35H22W25M-FI	
TKP35H22W38M-MO	TKP35H22-30/40W38R■M
TKP35H22W38M-MI	
TKP35H22W38M-FO	
TKP35H22W38M-FI	
TKP35H22W50M-MO	TKP35H22-30/40W50R■M
TKP35H22W50M-MI	
TKP35H22W50M-FO	
TKP35H22W50M-FI	
TKP35H22W63M-MO	TKP35H22-30/40W63R■M
TKP35H22W63M-MI	
TKP35H22W63M-FO	
TKP35H22W63M-FI	
TKP35H32W16M-MO	TKP35H32-30W16R■M
TKP35H32W16M-MI	
TKP35H32W16M-FO	
TKP35H32W16M-FI	

TKP45H25 MW Type

TKP45H25 - (1) W (2) R (3) M + (4) L - (5) - (6)

(1) Opening options	(2) Inner width	(3) Bending radius	(4) Number of links	(5) Fixed end	(6) Moving end
30 Outside openable stay	38	50 125		FOA FIB	MOA MIB
40 Inside openable stay	58	75 150		FIA FC	MIA MC
	78	95 200		FOB	MOB
	103				

Steel bracket

Model number	For cable carrier model number
TKP45H25-MOA	TKP45H25-30/40W■R■M
TKP45H25-MIA	
TKP45H25-MOB	
TKP45H25-MIB	
TKP45H25-MC	TKP45H25-30/40W■R■M
TKP45H25-FOA	
TKP45H25-FIA	
TKP45H25-FOB	
TKP45H25-FIB	
TKP45H25-FC	

Vertical divider

Model number	For cable carrier model number
TKP45H25M-ST	TKP45H25-30/40W■R■M

Horizontal divider

Model number	For cable carrier model number
TKP45H25M-HS38	TKP45H25-30/40W38R■M
TKP45H25M-HS58	TKP45H25-30/40W58R■M
TKP45H25M-HS78	TKP45H25-30/40W78R■M
TKP45H25M-HS103	TKP45H25-30/40W103R■M

## Structure

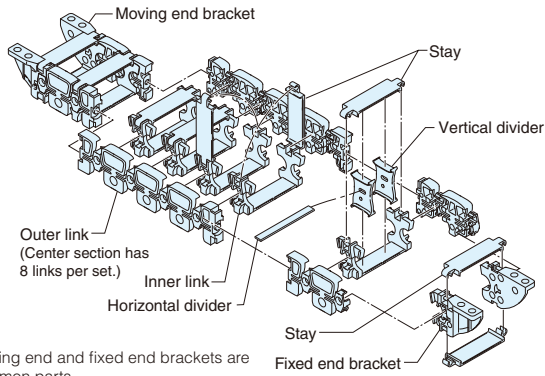

Note: 1. Moving end and fixed end brackets are common parts.  
 2. Due to the structure, the number of links is always even. (Cutting and connecting is done on every second links.)

## Cross-section dimensions

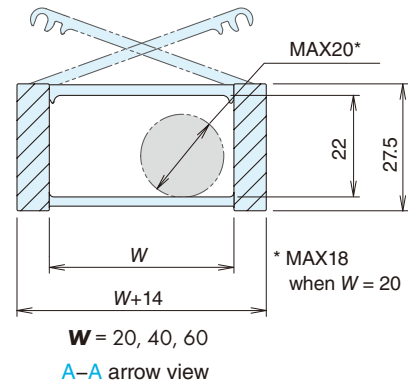

## Divider dimensions

### (1) When using only vertical dividers

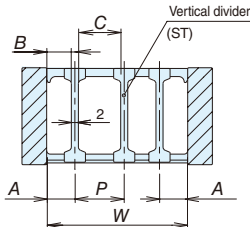

### (2) Fully-stayed 2-layers height separation

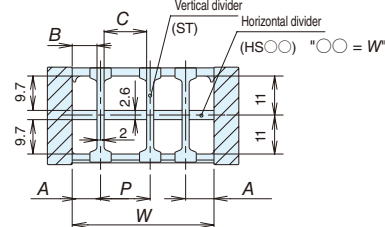

Vertical divider (fastening method)	Inner width W (mm)	A (mm)	B (mm)	P (mm)	C (mm)
ST (sliding installation)	Common for all widths	5 to 21	4 to 20	6 to 50	4 to 48
ST (fixable installation)	20	6, 8	5, 7	6, 8	4, 6
	40	6 to 20 Independent 2 mm	5 to 19 Independent 2 mm	6 to 28 Independent 2 mm	4 to 26 Independent 2 mm
	60	6 to 20	5 to 19	6 to 48	4 to 46

Note: The maximum values for A, B, P, and C are applied when using horizontal dividers.

#### Notes:

- A: Distance from center of vertical divider to end face of link
- B: Gap between vertical divider and link
- P: Distance between the centers of neighboring vertical dividers
- C: Gap between neighboring vertical dividers

Note: Make the gap between cables/hoses and the divider or link (d in the figure to right) to whichever of the following two values is larger: 2 mm or greater or the outer diameter of the cable or hose x 0.1.

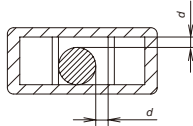

## Vertical divider (fastening method)

Fixable installation and sliding installation can be selected by the direction the same part is installed.

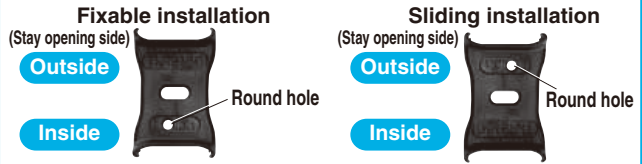

## Dimensions & brackets

W (mm)	a (mm)	b (mm)	Bending radius R (mm)	Mounting height H' (mm)
20	31	40	40	120 to 140
40	51	60	50	140 to 160
60	71	80	75	190 to 210

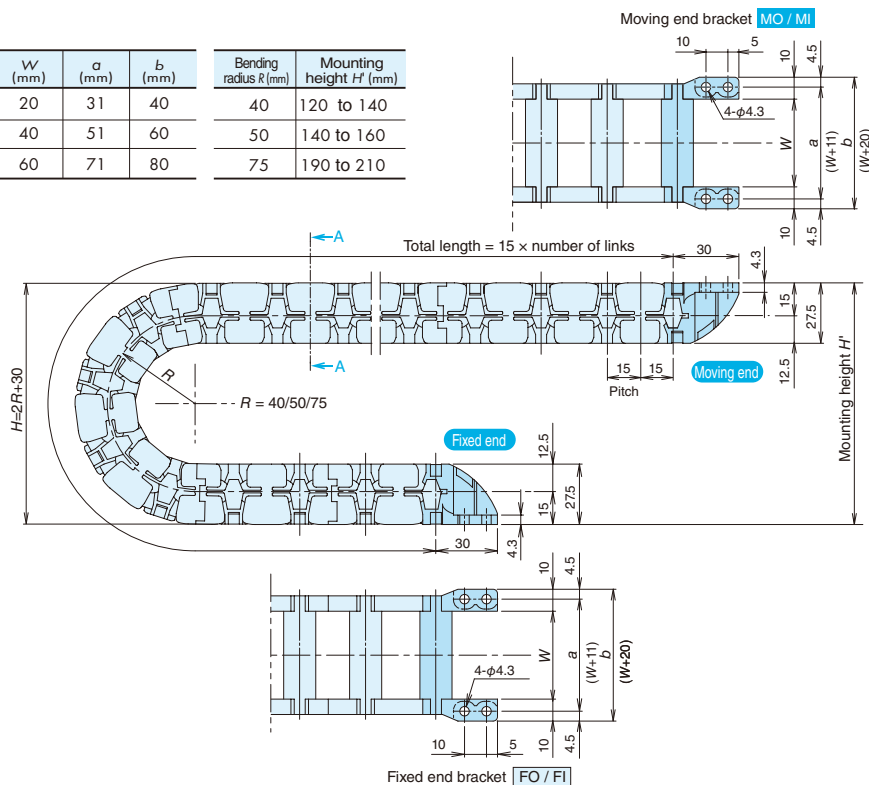

Notes: 1. MO and FO brackets are common parts.  
 2. MI and FI brackets are common parts.

#### Bracket mounting directions

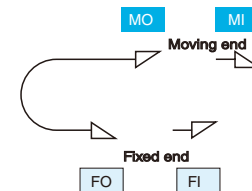

Note: Design and install according to the mounting height H' dimension.

### Basic specifications

Maximum travel speed (m/min)	300 *1	
Operating temperature range (°C)	-40 to 80	
Materials	Link	Engineering plastic (black)
	Bracket	
	Vertical divider	
	Horizontal divider	Engineering plastic (white)
Standard length (No. of links)	Specified number of links	

- Notes: ★1. 150 m/min for support roller arrangement.
- Contact a Tsubaki representative regarding maximum acceleration.
  - Cannot be used in acidic or alkaline environments.

### Load diagram

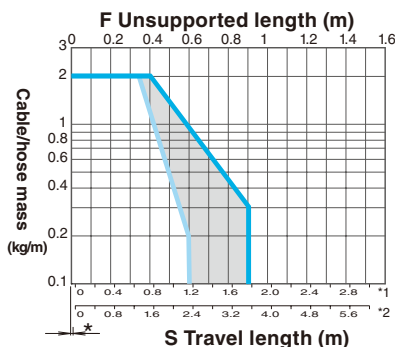

- \* Includes leeway length.
- \* 1: Without support rollers
- \* 2: With support rollers

Note: At the conditions in the shaded area of the load diagram, the unsupported length section may run with a sag. This may cause interference between the cable carrier and equipment depending on the installation conditions. Contact a Tsubaki representative for further information.

### Calculating no. of links

$$\text{Number of links} = \frac{\frac{S}{2} + \pi R + 2K}{P}$$

Note: When fixed end is at the center of the travel length. Always round up the value.  
\* Due to the structure, the number of links must be even.

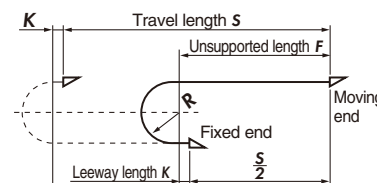

- S: Travel length (mm)
- R: Bending radius (mm)
- P: Pitch = 15 mm
- K: Leeway length = 15 mm or greater

\* Set the leeway length K to 23 mm or greater for support roller arrangement. Set the installation distance of support rollers to 350 mm or less.

### Model number

**TKR15H22 - (1) W (2) R (3) + (4) L - (5) - (6)**

(1) Opening options	(2) Inner width	(3) Bending radius	(4) Number of links	(5) Fixed end	(6) Moving end
30   Outside openable stay	20 40 60	40 50 75		FO FI	MO MI

- Notes:
- Moving end and fixed end brackets are common parts.
  - Dividers are delivered uninstalled.
  - Brackets are delivered installed.
  - Required number of vertical dividers: (normally installed every 4 links = installed every 2 stays)
    - Number of links N for installing vertical dividers = Total number of links (even) ÷ 4
    - N: Integer (round down decimals)
    - Required number of vertical dividers = N × n
    - n: Number of vertical dividers installed per spot on the link
  - Install vertical dividers from second stay on the moving end.

### Plastic link (extension)

**TKR15H22 - (1) W (2) R (3) ETL + (4) L**

(1) Opening options	(2) Inner width	(3) Bending radius	(4) Number of links
30   Outside openable stay	20 40 60	40 50 75	

### Divider

Type	Model number	Part	Unit
(1) Vertical divider	TKR15H22-ST	1 vertical divider	K (pcs)
(2) Horizontal divider (For DSA type)	TKR15H22-HS (Dimension W) W = 20/40/60	1 horizontal divider	K (pcs)

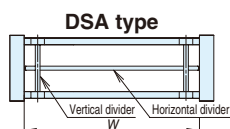

Note: 2 or more vertical dividers are required.

### Vertical divider

Model number	For cable carrier model number
TKR15H22-ST	TKR15H22-30W■■R■■

### Horizontal divider

Model number	For cable carrier model number
TKR15H22-HS20	TKR15H22-30W20R■■
TKR15H22-HS40	TKR15H22-30W40R■■
TKR15H22-HS60	TKR15H22-30W60R■■

### Bracket

Model number	For cable carrier model number
TKR15H22W20-MO	TKR15H22-30W20R■■
TKR15H22W20-MI	
TKR15H22W20-FO	
TKR15H22W20-FI	
TKR15H22W40-MO	TKR15H22-30W40R■■
TKR15H22W40-MI	
TKR15H22W40-FO	
TKR15H22W40-FI	
TKR15H22W60-MO	TKR15H22-30W60R■■
TKR15H22W60-MI	
TKR15H22W60-FO	
TKR15H22W60-FI	

- Adding additional links**
- Ordering
  - When ordering, be sure that the plastic link (extension) model number is for an even number of links.
  - Delivery: (1), (2), and (3) below are delivered uninstalled in the following quantities.
    - Outer links: (Quantity (number of links) ÷ 8 (round up) × 2 (left/right) × Number of sets
    - Inner links: (Quantity (number of links) ÷ 2) × Number of sets
    - Stays: (Quantity (number of links) ÷ 2) × Number of sets
- \* Outer links are common parts for both left and right sides. 8 links = 1 set and are delivered uncut.
- Ex. 1: TKR15H22-30W20R40ETL+2L 1H 2 links × 1 set  
 (1) Outer links: 2 (2) Inner links: 1 (3) Stay: 1
- Ex. 2: TKR15H22-30W20R40ETL+10L 2H 10 links × 2 sets  
 (1) Outer links: 8 (2) Inner links: 10 (3) Stays: 10

## Structure

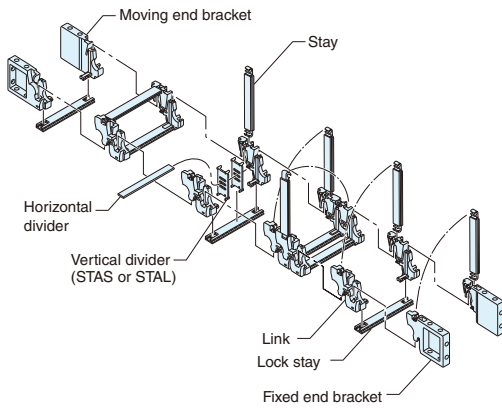

## Cross-section dimensions

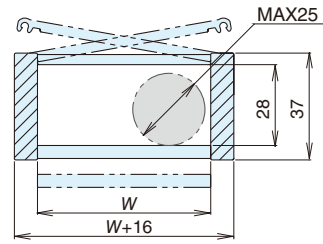

$W = 30, 40, 50, 60, 80, 100, 120$

A-A arrow view

## Divider dimensions

### (1) When using only vertical dividers

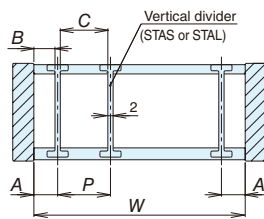

### (2) Fully-stayed multiple height separation (DSA type)

#### When separating into 2 layers

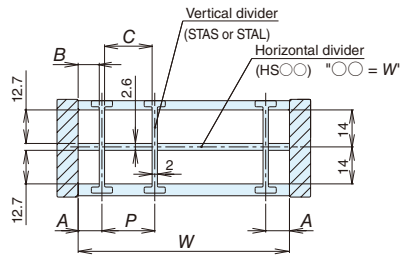

#### When separating into 3 layers

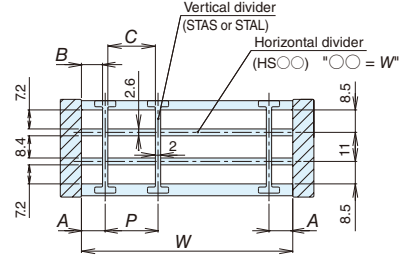

Vertical divider (fastening method)	Inner width W (mm)	A (mm)	B (mm)	P (mm)	C (mm)
STAS (sliding installation)	Common for all widths	4 to 21	3 to 20	8 to 82	6 to 80
STAL (fixable installation)	30	7 to 15	6 to 14	8 to 16	6 to 14
	40	4 to 20	3 to 19	8 to 32	6 to 30
	50	5 to 21	4 to 20	8 to 40	6 to 38
	60	6 to 18	5 to 17	8 to 48	6 to 46
	80	4 to 20	3 to 19	8 to 72	6 to 70
	100	6 to 18	5 to 17	8 to 80	6 to 82
	120	4 to 20	3 to 19	8 to 80	6 to 82

Note: The maximum values for A, B, P, and C are applied when using horizontal dividers.

#### Notes:

- A: Distance from center of vertical divider to end face of link
- B: Gap between vertical divider and link
- P: Distance between the centers of neighboring vertical dividers
- C: Gap between neighboring vertical dividers

Note: Make the gap between cables/hoses and the divider or link (d in the figure to right) to whichever of the following two values is larger: 2 mm or greater or the outer diameter of the cable or hose x 0.1.

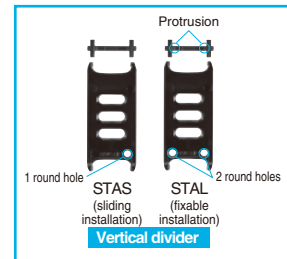
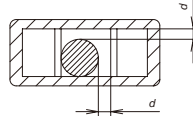

## Dimensions & brackets

W (mm)	a (mm)	b (mm)	Bending radius R (mm)	Mounting height H' (mm)
30	42	50	55	182 to 202
40	52	60	75	222 to 242
50	62	70	95	262 to 282
60	72	80	150	372 to 392
80	92	100		
100	112	120		
120	132	140		

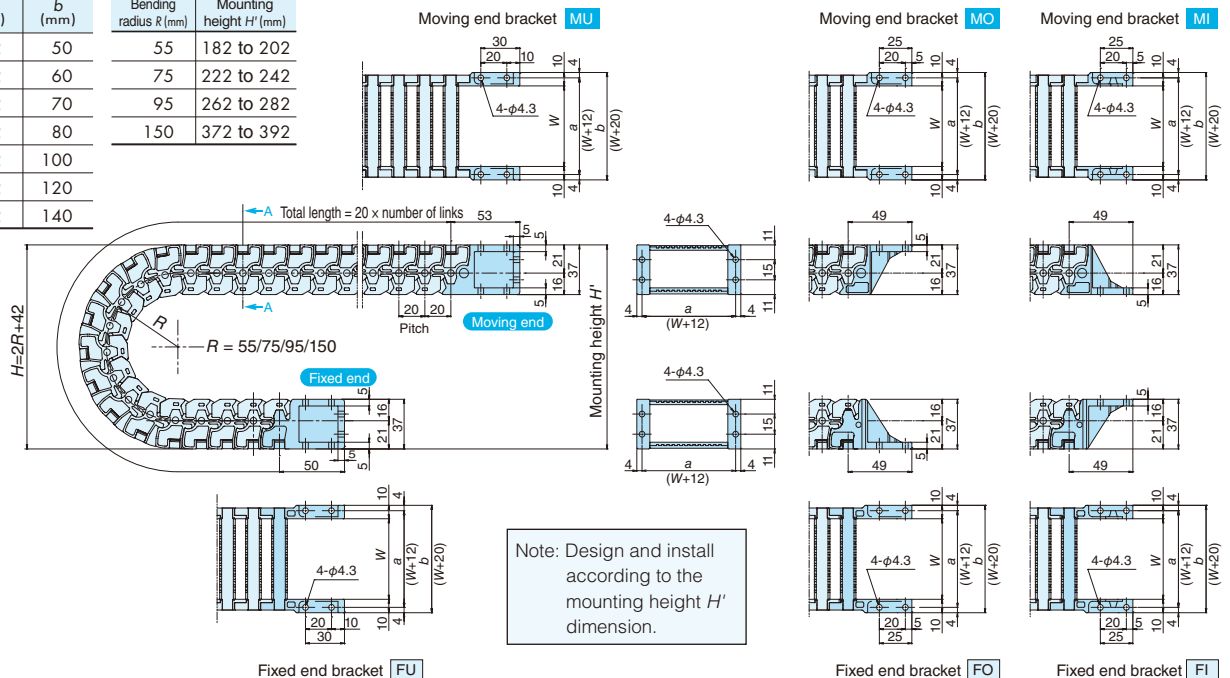

Note: The brackets are all different parts.

### Basic specifications

Maximum travel speed (m/min)	300 *1	
Operating temperature range (°C)	-40 to 80	
Materials	Link	Engineering plastic (black)
	Bracket	
	Vertical divider	
	Horizontal divider	Engineering plastic (white)
Standard length (No. of links)	100	

- Notes: ★1. 150 m/min for support roller arrangement.  
 2. Contact a Tsubaki representative regarding maximum acceleration.  
 3. Cannot be used in acidic or alkaline environments.

### Load diagram

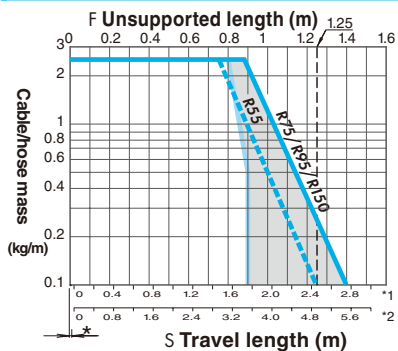

- \* Includes leeway length.
- \* 1: Without support rollers
- \* 2: With support rollers

Note: At the conditions in the shaded area of the load diagram, the unsupported length section may run with a sag. This may cause interference between the cable carrier and equipment depending on the installation conditions. Contact a Tsubaki representative for further information.

### Calculating no. of links

$$\text{Number of links} = \frac{S}{2} + \pi R + \frac{2K}{P}$$

Note: When fixed end is at the center of the travel length. Always round up the value.

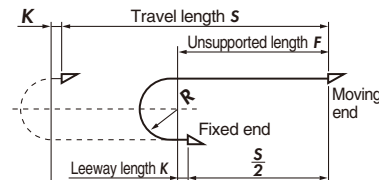

- S: Travel length (mm)
- R: Bending radius (mm)
- P: Pitch = 20 mm
- K: Leeway length = 40 mm or greater

\* Set the leeway length K to 60 mm or greater for support roller arrangement. Set the installation distance of support rollers to 700 mm or less.

### Model number

**TKR20H28W (1) R (2) + (3)L - (4) - (5)**

(1) Inner width	(2) Bending radius	(3) Number of links	(4) Fixed end	(5) Moving end
30	55		FU	MU
40	75		FO	MO
50	95			
60	150			
80				
100				
120				

- Notes: 1. Dividers are delivered uninstalled.  
 2. Brackets are delivered installed.  
 3. Required number of vertical dividers: (normally installed every 2 links)  
 Number of links N for installing vertical dividers = (Total number of links + 1) ÷ 2  
 N: Integer (round down decimals)  
 Required number of vertical dividers = N x n  
 n: Number of vertical dividers installed per spot on the link

#### Divider

Type	Model number	Part	Unit
(1) Vertical divider (sliding installation)	TKR20H28-STAS	1 vertical divider	K (pcs)
(2) Vertical divider (fixable installation)	TKR20H28-STAL	1 vertical divider	K (pcs)
(3) Horizontal divider (For DSA type)	TKR20H28-HS (Dimension W) W = 30/40/50/60/80/100/120	1 horizontal divider	K (pcs)

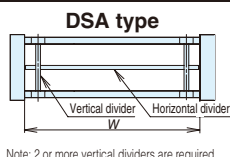

Note: 2 or more vertical dividers are required.

#### Vertical divider

Model number	For cable carrier model number
TKR20H28-STAS	TKR20H28W ■■ R ■■
TKR20H28-STAL	

#### Horizontal divider

Model number	For cable carrier model number
TKR20H28-HS30	TKR20H28W30R ■■
TKR20H28-HS40	TKR20H28W40R ■■
TKR20H28-HS50	TKR20H28W50R ■■
TKR20H28-HS60	TKR20H28W60R ■■
TKR20H28-HS80	TKR20H28W80R ■■
TKR20H28-HS100	TKR20H28W100R ■■
TKR20H28-HS120	TKR20H28W120R ■■

#### Bracket

Model number	For cable carrier model number
TKR20H28W30-MU	TKR20H28W30R ■■
TKR20H28W30-MO	
TKR20H28W30-MI	
TKR20H28W30-FU	
TKR20H28W30-FO	
TKR20H28W40-MU	TKR20H28W40R ■■
TKR20H28W40-MO	
TKR20H28W40-MI	
TKR20H28W40-FU	
TKR20H28W40-FO	
TKR20H28W50-MU	TKR20H28W50R ■■
TKR20H28W50-MO	
TKR20H28W50-MI	
TKR20H28W50-FU	
TKR20H28W50-FO	
TKR20H28W60-MU	TKR20H28W60R ■■
TKR20H28W60-MO	
TKR20H28W60-MI	
TKR20H28W60-FU	
TKR20H28W60-FO	
TKR20H28W80-MU	TKR20H28W80R ■■
TKR20H28W80-MO	
TKR20H28W80-MI	
TKR20H28W80-FU	
TKR20H28W80-FO	
TKR20H28W100-MU	TKR20H28W100R ■■
TKR20H28W100-MO	
TKR20H28W100-MI	
TKR20H28W100-FU	
TKR20H28W100-FO	
TKR20H28W120-MU	TKR20H28W120R ■■
TKR20H28W120-MO	
TKR20H28W120-MI	
TKR20H28W120-FU	
TKR20H28W120-FO	

See page 15 for ordering information

See page 147 for product mass





### Basic specifications

Maximum travel speed (m/min)	300 *1	
Operating temperature range (°C)	-40 to 80	
Materials	Link	Engineering plastic (black)
	Bracket	
	Vertical divider	Aluminum
Horizontal divider	For DSA type (HS)	
	For DSB type (EHS)	Engineering plastic + aluminum (black)
Standard length (No. of links)	100	

- Notes: ★1. 150 m/min for support roller arrangement.  
 2. Contact a Tsubaki representative regarding maximum acceleration.  
 3. Cannot be used in acidic or alkaline environments.

### Load diagram

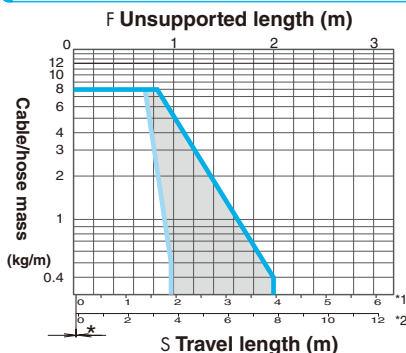

\* Includes leeway length.  
 \* 1: Without support rollers  
 \* 2: With support rollers

Note: At the conditions in the shaded area of the load diagram, the unsupported length section may run with a sag. This may cause interference between the cable carrier and equipment depending on the installation conditions. Contact a Tsubaki representative for further information.

### Calculating no. of links

$$\text{Number of links} = \frac{\frac{S}{2} + \pi R + 2K}{P}$$

Note: When fixed end is at the center of the travel length. Always round up the value.

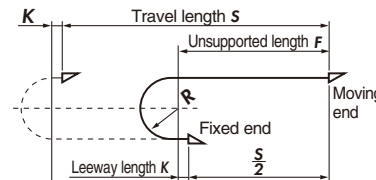

**S:** Travel length (mm)  
**R:** Bending radius (mm)  
**P:** Pitch = 26 mm  
**K:** Leeway length = 52 mm or greater

\* Set the leeway length K to 78 mm or greater for support roller arrangement. Set the installation distance of support rollers to 700 mm or less.

### Model number

**TKR26H40W (1) R (2) + (3)L - (4) - (5)**

(1) Inner width	(2) Bending radius	(3) Number of links	(4) Fixed end	(5) Moving end
50	75		FU	MU
62	100		FUCL *4	MUCL *4
75	125		FUCR	MUCR
87	150			
100				
125				
150				
200				

- Notes: 1. Dividers, strain relief combs, and clamp rails are delivered uninstalled.  
 2. Brackets are delivered installed.  
 3. Required number of vertical dividers: (normally installed every 2 links)  
 Number of links N for installing vertical dividers = (Total number of links + 1) ÷ 2  
 N: Integer (round down decimals)  
 Required number of vertical dividers = N x n  
 n: Number of vertical dividers installed per spot on the link  
 ★4. Those for W = 62, 87, and 200 cannot use the FUCL fixed end and MUCL moving end.

### Divider

Method	Type	Model number	Part	Unit
DSA type	Vertical divider	Sliding installation	TKR26H40-STAS	1 vertical divider
		Fixable installation	TKR26H40-STAL	1 vertical divider
	Horizontal divider	TKR26H40-HS (Dimension W) W = 50/62/75/87/100/125/150/200	1 horizontal divider	K (pcs)
DSB type	Vertical divider	Sliding installation	TKR26H40-STBS	1 vertical divider
		Fixable installation	TKR26H40-STBL	1 vertical divider
	Horizontal divider with end adapters	TKR26H40-EHS △△ △△ = Dimension C or D of divider dimensions	1 horizontal divider 2 end adapters	K (pcs)

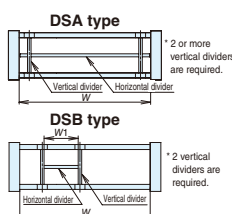

### Strain relief comb (plastic)

Model number	Applicable bracket
TKR26H40W50-CL-U	TKR26H40W50-MU/FU
TKR26H40W75-CL-U	TKR26H40W75-MU/FU
TKR26H40W100-CL-U	TKR26H40W100-MU/FU
TKR26H40W125-CL-U	TKR26H40W125-MU/FU
TKR26H40W150-CL-U	TKR26H40W150-MU/FU

Note: None for W62, 87, and 200.

### Vertical divider

Model number	For cable carrier model number
TKR26H40-STAS	TKR26H40W***R**
TKR26H40-STAL	
TKR26H40-STBS	
TKR26H40-STBL	

### Horizontal divider with end adapters

Model number
TKR26H40-EHS △△

△△: 20 to less than 188 \* Minimum 0.5 mm each

### Horizontal divider

Model number	For cable carrier model number
TKR26H40-HS50	TKR26H40W50R**
TKR26H40-HS62	TKR26H40W62R**
TKR26H40-HS75	TKR26H40W75R**
TKR26H40-HS87	TKR26H40W87R**
TKR26H40-HS100	TKR26H40W100R**
TKR26H40-HS125	TKR26H40W125R**
TKR26H40-HS150	TKR26H40W150R**
TKR26H40-HS200	TKR26H40W200R**

### Clamp rail (steel)

Model number	Applicable bracket
TKR26H40W50-CRA	TKR26H40W50-MU/FU
TKR26H40W62-CRA	TKR26H40W62-MU/FU
TKR26H40W75-CRA	TKR26H40W75-MU/FU
TKR26H40W87-CRA	TKR26H40W87-MU/FU
TKR26H40W100-CRA	TKR26H40W100-MU/FU
TKR26H40W125-CRA	TKR26H40W125-MU/FU
TKR26H40W150-CRA	TKR26H40W150-MU/FU
TKR26H40W200-CRA	TKR26H40W200-MU/FU

### Bracket

Model number	For cable carrier model number
TKR26H40W50-MU	TKR26H40W50R**
TKR26H40W50-FU	
TKR26H40W62-MU	TKR26H40W62R**
TKR26H40W62-FU	
TKR26H40W75-MU	TKR26H40W75R**
TKR26H40W75-FU	
TKR26H40W87-MU	TKR26H40W87R**
TKR26H40W87-FU	
TKR26H40W100-MU	TKR26H40W100R**
TKR26H40W100-FU	
TKR26H40W125-MU	TKR26H40W125R**
TKR26H40W125-FU	
TKR26H40W150-MU	TKR26H40W150R**
TKR26H40W150-FU	
TKR26H40W200-MU	TKR26H40W200R**
TKR26H40W200-FU	

### Bracket (with 1 strain relief comb)

Model number	For cable carrier model number
TKR26H40W50-MUCL	TKR26H40W50R**
TKR26H40W50-FUCL	
TKR26H40W75-MUCL	TKR26H40W75R**
TKR26H40W75-FUCL	
TKR26H40W100-MUCL	TKR26H40W100R**
TKR26H40W100-FUCL	
TKR26H40W125-MUCL	TKR26H40W125R**
TKR26H40W125-FUCL	
TKR26H40W150-MUCL	TKR26H40W150R**
TKR26H40W150-FUCL	

### Bracket (with 1 clamp rail)

Model number	For cable carrier model number
TKR26H40W50-MUCR	TKR26H40W50R**
TKR26H40W50-FUCR	
TKR26H40W62-MUCR	TKR26H40W62R**
TKR26H40W62-FUCR	
TKR26H40W75-MUCR	TKR26H40W75R**
TKR26H40W75-FUCR	
TKR26H40W87-MUCR	TKR26H40W87R**
TKR26H40W87-FUCR	
TKR26H40W100-MUCR	TKR26H40W100R**
TKR26H40W100-FUCR	
TKR26H40W125-MUCR	TKR26H40W125R**
TKR26H40W125-FUCR	
TKR26H40W150-MUCR	TKR26H40W150R**
TKR26H40W150-FUCR	
TKR26H40W200-MUCR	TKR26H40W200R**
TKR26H40W200-FUCR	

## Structure

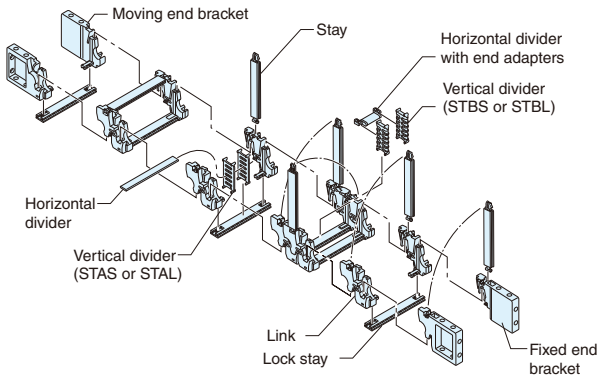

## Cross-section dimensions

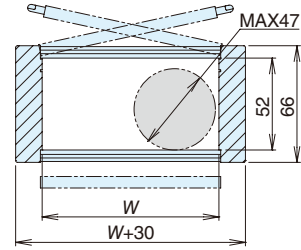

W = 50, 62, 75, 87, 100, 125, 150, 200  
A-A arrow view

## Divider dimensions

(1) When using only vertical dividers

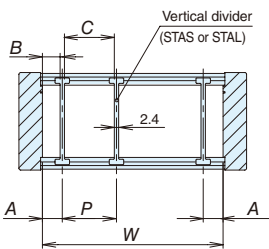

(2) Fully-stayed multiple height separation (DSA type)

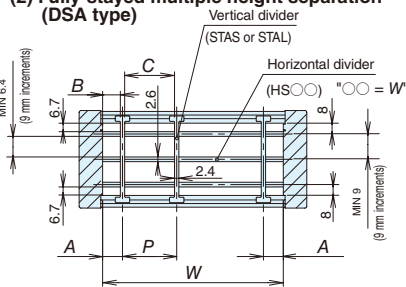

(3) Partial multiple height separation (DSB type)

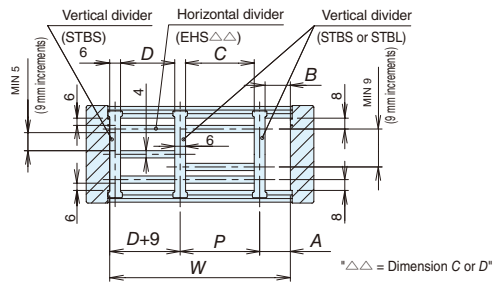

\*△△ = Dimension C or D\*

Vertical divider (sliding method)	Inner width W (mm)	A (mm)	B (mm)	P (mm)	C (mm)	D (mm)
STAS (sliding installation)	Common for all widths	3 to 65	1.8 to 63.8	8 to 130	5.6 to 127.6	
STAL (fixable installation)	50	5 to 37	3.8 to 35.8	8 to 40	5.6 to 37.6	
	62	7 to 47	5.8 to 45.8	8 to 48	5.6 to 45.6	4mm increments
	75	5.5 to 61.5	4.3 to 60.3	8 to 64	5.6 to 61.6	4mm increments
	87	3.5 to 63.5	2.3 to 62.3	8 to 80	5.6 to 77.6	4mm increments
	100	6 to 62	4.8 to 60.8	8 to 88	5.6 to 85.6	4mm increments
	125	6.5 to 62.5	5.3 to 61.3	8 to 112	5.6 to 109.6	4mm increments
STBS (sliding installation)	Common for all widths	min 3	min 0	26 to (W-6)	20 to (W-12)	20 to (W-12)
	50	min 5	min 2	-	-	20 to 36
	62	min 7	min 4	-	-	22 to 46
	75	min 5.5	min 2.5	28 to 40	22 to 34	20.5 to 60.5
STBL (fixable installation)	87	min 3.5	min 0.5	28 to 52	22 to 46	22.5 to 74.5
	100	min 6	min 3	28 to 64	22 to 58	21 to 85
	125	min 6.5	min 3.5	28 to 88	22 to 82	21.5 to 109.5
	150	min 7	min 4	28 to 112	22 to 106	22 to 134
	200	min 4	min 1	28 to 164	22 to 158	23 to 187

**Notes:**

- A: Distance from center of vertical divider to end face of link
- B: Gap between vertical divider and link
- P: Distance between the centers of neighboring vertical dividers
- C: Gap between neighboring vertical dividers
- D: Gap between neighboring vertical dividers when vertical dividers / dividers for both ends are installed

Note: Make the gap between cables/hoses and the divider or link (d in the figure to the right) to whichever of the following two values is larger: 2mm or greater or the outer diameter of the cable or hose x 0.1.

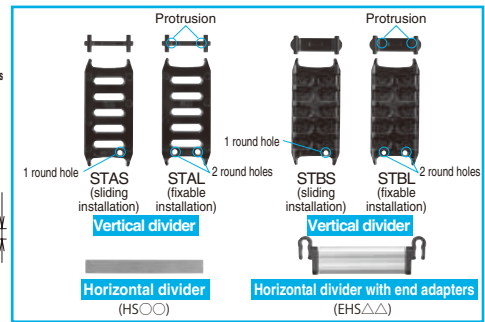
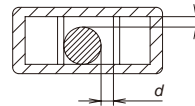

Note: The maximum values for A, B, P, and C are applied when using horizontal dividers.

## Dimensions & brackets

W (mm)	a (mm)	b (mm)	c (mm)	Strain relief comb n <sub>z</sub> (toothed)
50	66	80	33	3
62	78	92	-	-
75	91	105	58	5
87	103	117	-	-
100	116	130	83	7
125	141	155	108	9
150	166	180	133	11
200	216	230	-	-

Bending radius R (mm)	Mounting height H' (mm)
75	252 to 272
100	302 to 322
150	402 to 422
200	502 to 522

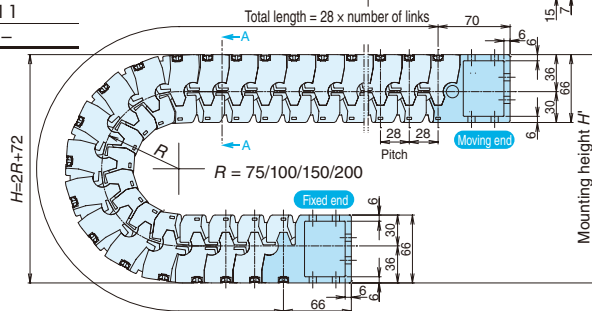

Moving end bracket **MU**

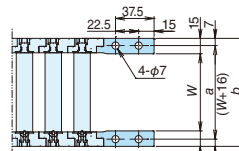

Moving end bracket **MUCL** (with 1 strain relief comb)

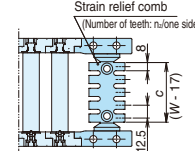

Moving end bracket **MUCR** (with 1 clamp rail)

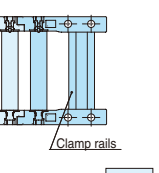
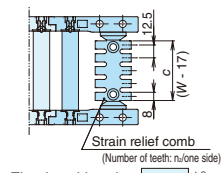
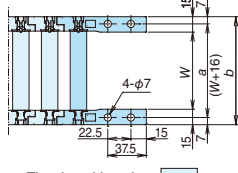
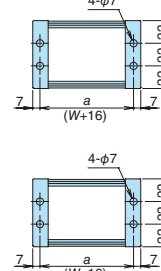
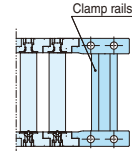

Note: Design and install according to the mounting height H' dimension.

- Notes:
- Strain relief combs and clamp rails can be installed on the inside and outside.
  - Note that the strain relief comb and clamp rail cannot be added to the MU and FU brackets.
  - Only when W = 50, 75, 100, 125, or 150.

Fixed end bracket **FU**

Fixed end bracket **FUCL** (with 1 strain relief comb)

Fixed end bracket **FUCR** (with 1 clamp rail)

### Basic specifications

Maximum travel speed (m/min)	300 *1	
Operating temperature range (°C)	-40 to 80	
Materials	Link	Engineering plastic (black)
	Bracket	
	Vertical divider	Aluminum
Horizontal divider	For DSA type (HS)	
	For DSB type (EHS)	Engineering plastic + aluminum (black)
Standard length (No. of links)	100	

- Notes: ★1. 150 m/min for support roller arrangement.
- Contact a Tsubaki representative regarding maximum acceleration.
  - Cannot be used in acidic or alkaline environments.

### Load diagram

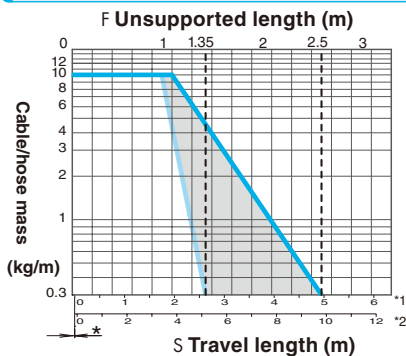

- \* Includes leeway length.
- \*1: Without support rollers
- \*2: With support rollers

Note: At the conditions in the shaded area of the load diagram, the unsupported length section may run with a sag. This may cause interference between the cable carrier and equipment depending on the installation conditions. Contact a Tsubaki representative for further information.

### Calculating no. of links

$$\text{Number of links} = \frac{S}{2} + \pi R + \frac{2K}{P}$$

Note: When fixed end is at the center of the travel length. Always round up the value.

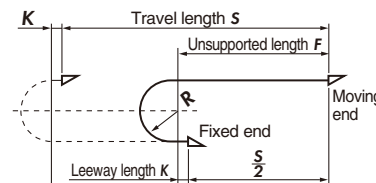

- S: Travel length (mm)
- R: Bending radius (mm)
- P: Pitch = 28 mm
- K: Leeway length = 56 mm or greater

\* Set the leeway length K to 84 mm or greater for support roller arrangement. Set the installation distance of support rollers to 900 mm or less.

### Model number

**TKR28H52W (1) R (2) + (3)L - (4) - (5)**

(1) Inner width	(2) Bending radius	(3) Number of links	(4) Fixed end	(5) Moving end
50	75		FU	MU
62	100		FUCL *4	MUCL *4
75	150		FUCR	MUCR
87	200			
100				
125				
150				
200				

- Notes:
- Dividers, strain relief combs, and clamp rails are delivered uninstalled.
  - Brackets are delivered installed.
  - Required number of vertical dividers: (normally installed every 2 links)  
Number of links N for installing vertical dividers = (Total number of links + 1) ÷ 2  
N: Integer (round down decimals)  
Required number of vertical dividers = N x n  
n: Number of vertical dividers installed per spot on the link
  - ★4. Those for W = 62, 87, and 200 cannot use the FUCL fixed end and MUCL moving end.

### Divider

Method	Type	Model number	Part	Unit
DSA type	Vertical divider	Sliding installation	TKR28H52-STAS	1 vertical divider
		Fixable installation	TKR28H52-STAL	1 vertical divider
	Horizontal divider	TKR28H52-HS (Dimension W) W = 50/62/75/87/100/125/150/200	1 horizontal divider	K (pcs)
DSB type	Vertical divider	Sliding installation	TKR28H52-STBS	1 vertical divider
		Fixable installation	TKR28H52-STBL	1 vertical divider
	Horizontal divider with end adapters	TKR28H52-EHS△△ △△ = Dimension C or D of divider dimensions	1 horizontal divider 2 end adapters	K (pcs)

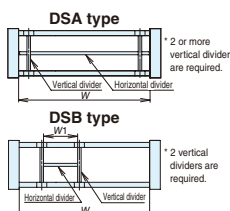

### Strain relief comb (plastic)

Model number	Applicable bracket
TKR28H52W50-CL-U	TKR28H52W50-MU/FU
TKR28H52W75-CL-U	TKR28H52W75-MU/FU
TKR28H52W100-CL-U	TKR28H52W100-MU/FU
TKR28H52W125-CL-U	TKR28H52W125-MU/FU
TKR28H52W150-CL-U	TKR28H52W150-MU/FU

Note: None for W62, 87, and 200.

### Vertical divider

Model number	For cable carrier model number
TKR28H52-STAS	TKR28H52W***
TKR28H52-STAL	
TKR28H52-STBS	
TKR28H52-STBL	
TKR28H52-STBL	

### Horizontal divider

Model number	For cable carrier model number
TKR28H52-HS50	TKR28H52W50R**
TKR28H52-HS62	TKR28H52W62R**
TKR28H52-HS75	TKR28H52W75R**
TKR28H52-HS87	TKR28H52W87R**
TKR28H52-HS100	TKR28H52W100R**
TKR28H52-HS125	TKR28H52W125R**
TKR28H52-HS150	TKR28H52W150R**
TKR28H52-HS200	TKR28H52W200R**

### Clamp rail (steel)

Model number	Applicable bracket
TKR28H52W50-CRA	TKR28H52W50-MU/FU
TKR28H52W62-CRA	TKR28H52W62-MU/FU
TKR28H52W75-CRA	TKR28H52W75-MU/FU
TKR28H52W87-CRA	TKR28H52W87-MU/FU
TKR28H52W100-CRA	TKR28H52W100-MU/FU
TKR28H52W125-CRA	TKR28H52W125-MU/FU
TKR28H52W150-CRA	TKR28H52W150-MU/FU
TKR28H52W200-CRA	TKR28H52W200-MU/FU

### Horizontal divider with end adapters

Model number
TKR28H52-EHS△△

△△: 20 to less than 188 \* Minimum 0.5 mm each

### Bracket

Model number	For cable carrier model number
TKR28H52W50-MU	TKR28H52W50R**
TKR28H52W50-FU	
TKR28H52W62-MU	TKR28H52W62R**
TKR28H52W62-FU	
TKR28H52W75-MU	TKR28H52W75R**
TKR28H52W75-FU	
TKR28H52W87-MU	TKR28H52W87R**
TKR28H52W87-FU	
TKR28H52W100-MU	TKR28H52W100R**
TKR28H52W100-FU	
TKR28H52W125-MU	TKR28H52W125R**
TKR28H52W125-FU	
TKR28H52W150-MU	TKR28H52W150R**
TKR28H52W150-FU	
TKR28H52W200-MU	TKR28H52W200R**
TKR28H52W200-FU	

### Bracket (with 1 strain relief comb)

Model number	For cable carrier model number
TKR28H52W50-MUCL	TKR28H52W50R**
TKR28H52W50-FUCL	
TKR28H52W75-MUCL	TKR28H52W75R**
TKR28H52W75-FUCL	
TKR28H52W100-MUCL	TKR28H52W100R**
TKR28H52W100-FUCL	
TKR28H52W125-MUCL	TKR28H52W125R**
TKR28H52W125-FUCL	
TKR28H52W150-MUCL	TKR28H52W150R**
TKR28H52W150-FUCL	

### Bracket (with 1 clamp rail)

Model number	For cable carrier model number
TKR28H52W50-MUCR	TKR28H52W50R**
TKR28H52W50-FUCR	
TKR28H52W62-MUCR	TKR28H52W62R**
TKR28H52W62-FUCR	
TKR28H52W75-MUCR	TKR28H52W75R**
TKR28H52W75-FUCR	
TKR28H52W87-MUCR	TKR28H52W87R**
TKR28H52W87-FUCR	
TKR28H52W100-MUCR	TKR28H52W100R**
TKR28H52W100-FUCR	
TKR28H52W125-MUCR	TKR28H52W125R**
TKR28H52W125-FUCR	
TKR28H52W150-MUCR	TKR28H52W150R**
TKR28H52W150-FUCR	
TKR28H52W200-MUCR	TKR28H52W200R**
TKR28H52W200-FUCR	



### Basic specifications

Maximum travel speed (m/min)	300 *1	
Operating temperature range (°C)	-40 to 80	
Materials	Link	Engineering plastic (black)
	Bracket	
	Vertical divider	Engineering plastic (white)
	Horizontal divider	
	Clamp	
Standard length (No. of links)	50	

- Notes: ★ 1. 150 m/min for support roller arrangement.  
 2. Contact a Tsubaki representative regarding maximum acceleration.  
 3. Cannot be used in acidic or alkaline environments.

### Load diagram

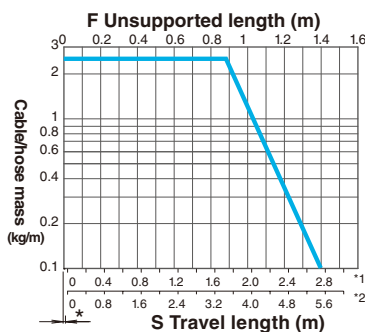

- \* Includes leeway length.  
 \* 1: Without support rollers  
 \* 2: With support rollers

### Calculating no. of links

$$\text{Number of links} = \frac{S}{2} + \pi R + \frac{2K}{P}$$

Note: When fixed end is at the center of the travel length. Always round up the value.

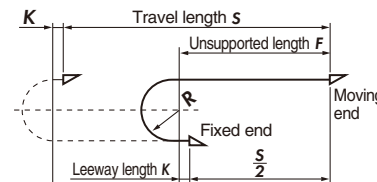

- S:** Travel length (mm)  
**R:** Bending radius (mm)  
**P:** Pitch = 37 mm  
**K:** Leeway length = 74 mm or greater

\* Set the leeway length K to 111 mm or greater for support roller arrangement.  
 Set the installation distance of support rollers to 700 mm or less.

### Model number

**TKR37H28W (1) R (2) + (3) L - (4) - (5)**

(1) Inner width	(2) Bending radius	(3) Number of links	(4) Fixed end	(5) Moving end
40	55		FU	MU
50	75		FUCLO	MUCLO
60	100		FUCLI	MUCLI
70			FUCLB	MUCLB
80				

- Notes: 1. Dividers are delivered uninstalled.  
 2. Brackets are delivered installed.  
 3. Install dividers every 2 links.  
 4. Required number of vertical dividers: (normally installed every 2 links)  
 Number of links N for installing vertical dividers = Total number of links ÷ 2 N: Integer (round down decimals)  
 Required number of vertical dividers = N x n n: Number of vertical dividers installed per spot on the link

#### Vertical divider

Model number	For cable carrier model number
TKR37H28-STAS	TKR37H28W■■R■■
TKR37H28-STAL	

#### Horizontal divider

Model number	For cable carrier model number
TKR37H28-HS40	TKR37H28W40R■■
TKR37H28-HS50	TKR37H28W50R■■
TKR37H28-HS60	TKR37H28W60R■■
TKR37H28-HS70	TKR37H28W70R■■
TKR37H28-HS80	TKR37H28W80R■■

#### Strain relief comb

Model number	Applicable bracket
TKR37H28W40-CL-U	TKR37H28W40-MU/FU
TKR37H28W50-CL-U	TKR37H28W50-MU/FU
TKR37H28W60-CL-U	TKR37H28W60-MU/FU
TKR37H28W70-CL-U	TKR37H28W70-MU/FU
TKR37H28W80-CL-U	TKR37H28W80-MU/FU

#### Bracket

Model number	For cable carrier model number
TKR37H28W40-MU	TKR37H28W40R■■
TKR37H28W40-FU	
TKR37H28W50-MU	TKR37H28W50R■■
TKR37H28W50-FU	
TKR37H28W60-MU	TKR37H28W60R■■
TKR37H28W60-FU	
TKR37H28W70-MU	TKR37H28W70R■■
TKR37H28W70-FU	
TKR37H28W80-MU	TKR37H28W80R■■
TKR37H28W80-FU	

#### Bracket (with 1 strain relief comb)

Model number	For cable carrier model number
TKR37H28W40-MUCLO	TKR37H28W40R■■
TKR37H28W40-FUCLO	
TKR37H28W40-MUCLI	
TKR37H28W40-FUCLI	TKR37H28W50R■■
TKR37H28W50-MUCLO	
TKR37H28W50-FUCLO	
TKR37H28W50-MUCLI	TKR37H28W60R■■
TKR37H28W50-FUCLI	
TKR37H28W60-MUCLO	
TKR37H28W60-FUCLO	TKR37H28W70R■■
TKR37H28W60-MUCLI	
TKR37H28W60-FUCLI	
TKR37H28W70-MUCLO	TKR37H28W70R■■
TKR37H28W70-FUCLO	
TKR37H28W70-MUCLI	
TKR37H28W70-FUCLI	TKR37H28W80R■■
TKR37H28W80-MUCLO	
TKR37H28W80-FUCLO	
TKR37H28W80-MUCLI	TKR37H28W80R■■
TKR37H28W80-FUCLI	

#### Bracket (with 2 strain relief combs)

Model number	For cable carrier model number
TKR37H28W40-MUCLB	TKR37H28W40R■■
TKR37H28W40-FUCLB	
TKR37H28W50-MUCLB	TKR37H28W50R■■
TKR37H28W50-FUCLB	
TKR37H28W60-MUCLB	TKR37H28W60R■■
TKR37H28W60-FUCLB	
TKR37H28W70-MUCLB	TKR37H28W70R■■
TKR37H28W70-FUCLB	
TKR37H28W80-MUCLB	TKR37H28W80R■■
TKR37H28W80-FUCLB	

See page 15 for ordering information

See page 148 for product mass

## Proposes a lightweight, compact-structure cable and hose carrier system

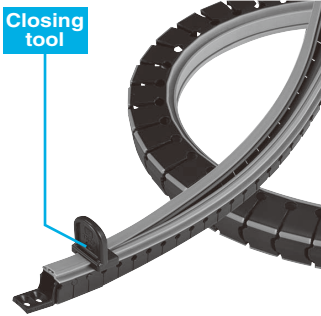

### Easy to handle thanks to its zipper structure

With the TKZP Series, cables and hoses can be set just by wrapping the cable carrier around the cables/hoses and zipping it up on the inside. This contributes to reduced labor for installation or maintenance of cables/hoses. In addition, it is easy to cut to the required length.

### Provides stable movement and low noise/low wear generating operation

Can bend in only one direction. Enables quiet, low wear operation thanks to its short-pitch and link-less structure. Contributes to protection of cables and hoses and maintaining a clean environment.

### Cable/hose storage

Cable/hose outer diameter (mm)	φ6 or less
Installing capacity	40% or less

### Installation dimensions

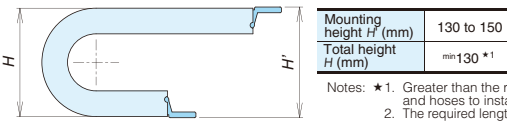

Notes: \*1. Greater than the rigidity of the cables and hoses to install.  
\*2. The required length changes when the mounting height is 150 mm or greater.

### Cross-section dimensions

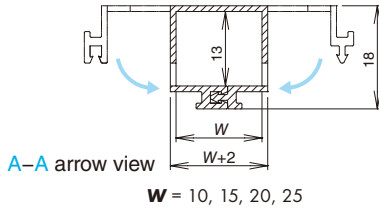

### Required length calculation

When mounting height H' = 130 to 150

$$\text{Minimum required length} = \frac{S}{2} + 270$$

(Integer multiple of 10)

Note: When fixed end is at the center of the travel length. Round up to integer multiple of 10 after calculating.

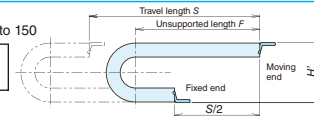

### Dimensions & brackets

- MO and FO brackets are common parts.
- MI and FI brackets are common parts.

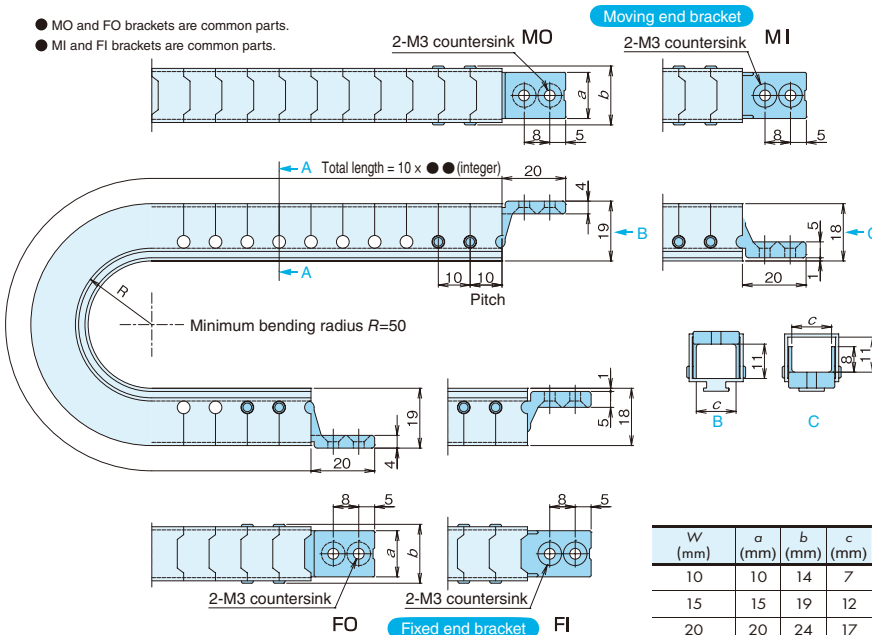

W (mm)	a (mm)	b (mm)	c (mm)
10	10	14	7
15	15	19	12
20	20	24	17
25	25	29	22

### Basic specifications/capacities

Model number	Material (color)		Operating temperature range (°C)
	Link	Bracket	
TKZP10H13-40W10	Special plastic (black/gray)	Engineering plastic (black)	10 to 80
TKZP10H13-40W15			
TKZP10H13-40W20			
TKZP10H13-40W25			

Model number	Maximum additional load (kg/m)
TKZP10H13-40W10	0.1
TKZP10H13-40W15	
TKZP10H13-40W20	0.2
TKZP10H13-40W25	

Maximum travel length (mm)	Maximum unsupported length (mm)	Maximum travel speed (m/min)	Maximum acceleration (m/s <sup>2</sup> )
1000 *	550 *	100	5

\*: The maximum value for additional load is 0 to 0.1 kg/m or 0.2 kg/m.

### Model number

## TKZP10H13-40W (1)

(1) Inner width
10
15
20
25

Note: Length per piece is 10 m.

### Closing tool

Model number	For cable carrier model number
TKZP10H13-AST	TKZP10H13-40W10
	TKZP10H13-40W15
	TKZP10H13-40W20
	TKZP10H13-40W25

Note: One closing tool is included per box.

### Bracket

Model number	For cable carrier model number
TKZP10H13W10-MO	TKZP10H13-40W10
TKZP10H13W10-MI	
TKZP10H13W10-FO	
TKZP10H13W10-FI	TKZP10H13-40W15
TKZP10H13W15-MO	
TKZP10H13W15-MI	
TKZP10H13W15-FO	
TKZP10H13W15-FI	TKZP10H13-40W20
TKZP10H13W20-MO	
TKZP10H13W20-MI	
TKZP10H13W20-FO	
TKZP10H13W20-FI	TKZP10H13-40W25
TKZP10H13W25-MO	
TKZP10H13W25-MI	
TKZP10H13W25-FO	
TKZP10H13W25-FI	

# Cable Carrier Plastic Series

## Closed type

### TKC Series

TKC28H30.....	79
TKC34H25.....	81
TKC47H36.....	83
TKC64H50.....	85
TKC85H68.....	87
TKC91H56.....	89
TKC91H80.....	91

# TKC28H30

(Patented)

## Structure

W28

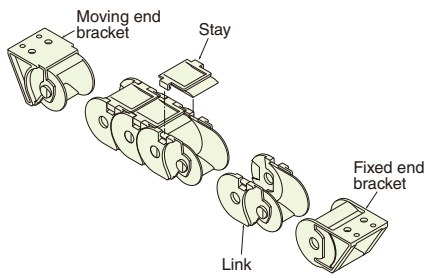

W48

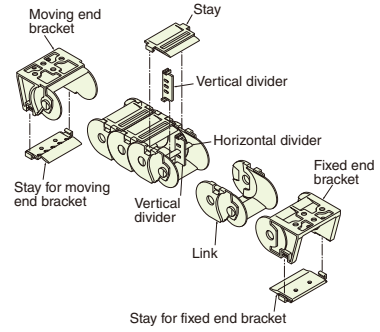

## Cross section/divider dimensions

W28

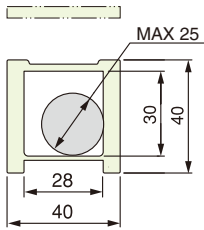

W48

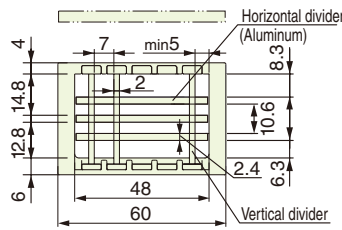

Note: Vertical dividers and horizontal dividers cannot be installed to the W28. A-A arrow view

Note: Vertical dividers can be installed at a pitch of 9 mm. They do not slide.

## Dimensions & brackets

W28

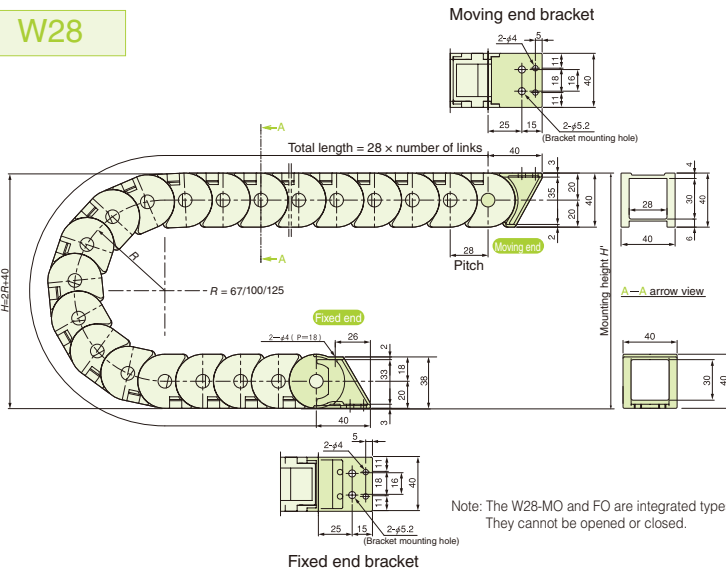

Bending radius R (mm)	Mounting height H' (mm)
67	184 to 204
100	250 to 270
125	300 to 320

Note: FO and FI brackets are common parts.

Note: Design and install according to the mounting height H' dimension.

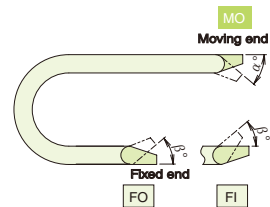

Bending radius R (mm)	Bending angle (°)	
	Moving end side (α)	Fixed end side (β)
67	24	24
100		16
125		12

W48

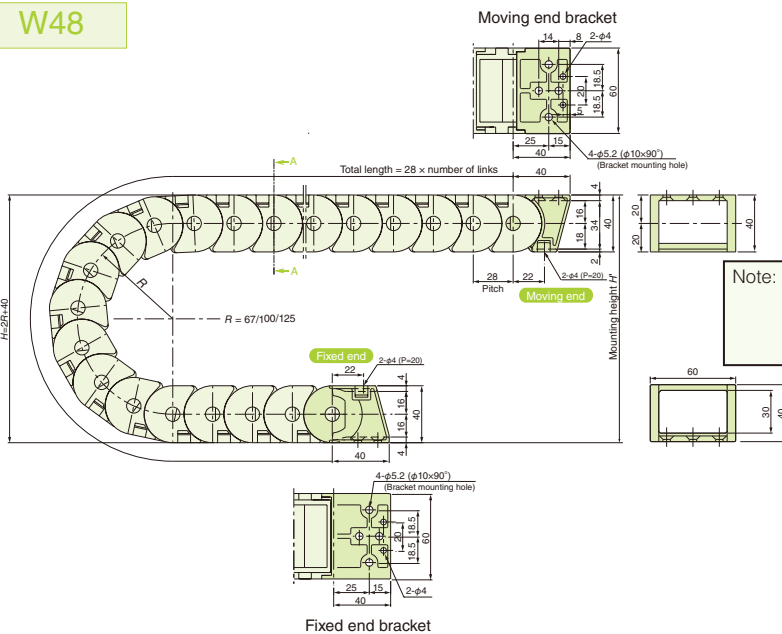

Bending radius R (mm)	Mounting height H' (mm)
67	184 to 204
100	250 to 270
125	300 to 320

Note: FO and FI brackets are common parts.

Note: Design and install according to the mounting height H' dimension.

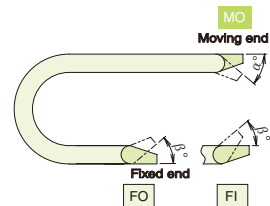

Bending radius R (mm)	Bending angle (°)	
	Moving end side (α)	Fixed end side (β)
67	24	24
100		16
125		12



### Basic specifications

Maximum travel speed (m/min)	300 *1	
Operating temperature range (°C)	-40 to 80	
Materials	Link	Engineering plastic (black)
	Bracket	
	Vertical divider	Engineering plastic (black)
	Horizontal divider	Aluminum
Standard length (No. of links)	30	

Notes: ★ 1. 150 m/min for support roller arrangement.  
2. Cannot be used in acidic or alkaline environments.

### Load diagram

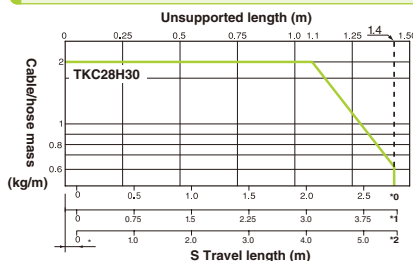

\* Includes leeway length.  
\* 0: Without support rollers  
\* 1: With support roller in 1 location  
\* 2: With support rollers in 2 locations

### Calculating no. of links

$$\text{Number of links} = \frac{S}{2} + \pi R + 2K$$

Note: When fixed end is at the center of the travel length. Always round up the value after calculating.

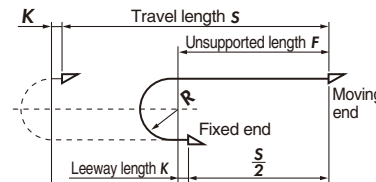

**S:** Travel length (mm)  
**R:** Bending radius (mm)  
**P:** Pitch = 28 mm  
**K:** Leeway length = 28 mm or greater

### Model number

**TKC28H30 - (1) W (2) R (3) + (4) L - (5) - (6)**

(1) Opening options	(2) Inner width	(3) Bending radius	(4) Number of links	(5) Fixed end	(6) Moving end
30 Outside openable stay	28 48	67 100 125		FO FI	MO

Notes: 1. Install dividers every 2 links.  
(Dividers cannot be installed to the W28.)  
2. Stays, brackets, and dividers for the plastic links are delivered uninstalled.

#### ■ Divider

Type	Model number	Part	Unit
(1) Vertical divider	TKC28H30-ST	1 vertical divider	K (pcs)
(2) Horizontal divider (For DSA type)	TKC28H30-HS (Dimension W) W = 48	1 horizontal divider	K (pcs)

Note: Vertical dividers and horizontal dividers cannot be installed to the W28.

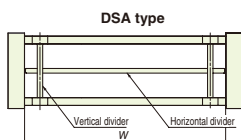

#### ■ Vertical divider

Model number	For cable carrier model number
TKC28H30-ST	TKC28H30-30W48R ■■

#### ■ Horizontal divider

Model number	For cable carrier model number
TKC28H30-HS48	TKC28H30-30W48R ■■

#### ■ Bracket

Model number	For cable carrier model number
TKC28H30W28-MO	TKC28H30-30W28R ■■
TKC28H30W28-FO	
TKC28H30W28-FI	
TKC28H30W48-MO	TKC28H30-30W48R ■■
TKC28H30W48-FO	
TKC28H30W48-FI	

See page 15 for ordering information

See page 149 for product mass

# TKC34H25

## Structure

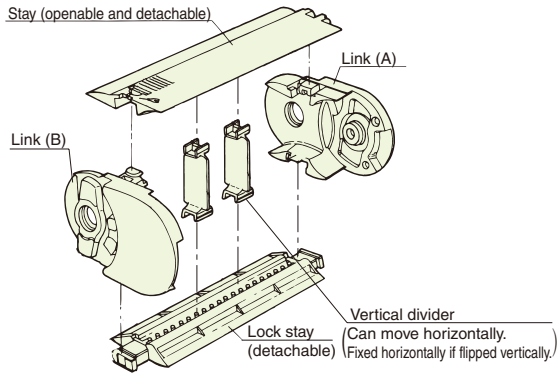

## Cross-section dimensions

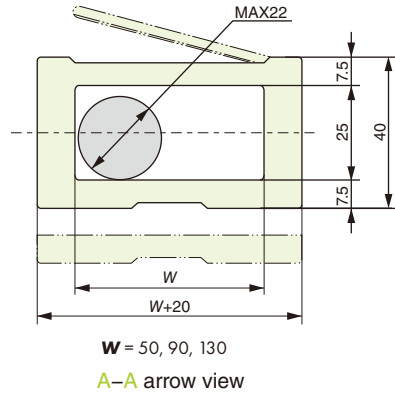

## Divider dimensions

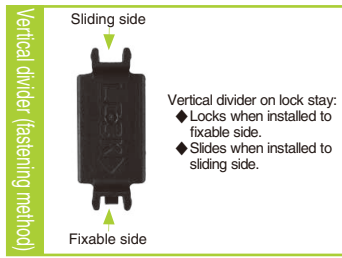
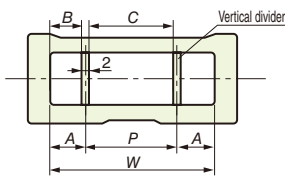

Note: Can slide between P {10 to (W-40)}. The fastening pitch of fixable dividers is 5 mm increments. However, the pitch of neighboring dividers is 10 mm or greater.

Vertical divider (fastening method)	Inner width W (mm)	A (mm)	B (mm)	P (mm)	C (mm)
ST (sliding installation)	Common for all width	min 20	min 19	10 to (W-40)	8 to (W-40)
ST (fixable installation)	50	20 to 30	19 to 29	10	8
	90	20 to 70	19 to 69	10 to 50	8 to 48
	130	20 to 110	19 to 129	10 to 90	8 to 88

A : Distance from center of vertical divider to end face of link  
 B : Gap between vertical divider and link  
 P : Distance between the centers of neighboring vertical dividers  
 C : Gap between neighboring vertical dividers

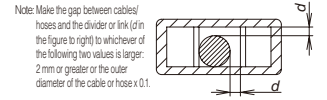

## Dimension drawings

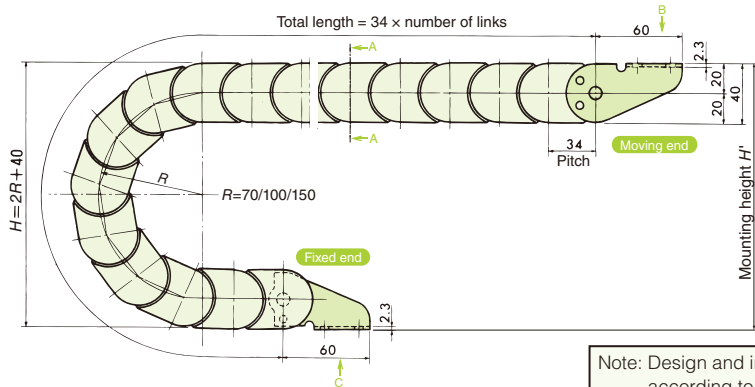

Note: Design and install according to the mounting height H' dimension.

Bending radius R (mm)	Mounting height H' (mm)
70	190 to 210
100	250 to 270
150	350 to 370

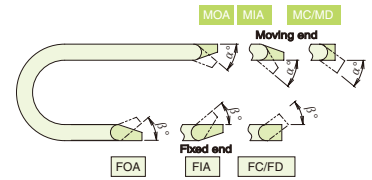

Bending radius R (mm)	Bending angle (°)	
	Moving end side (α)	Fixed end side (β)
70	29	29
100	20	
150	14	

## Steel bracket variants and dimensions

	Outside mounting				Inside mounting				Flange mounting		Flange mounting with cover	
	MOA	MIA	MC	MD	FIA	FIA	FC	FD	A (mm)	B (mm)	A (mm)	B (mm)
Moving end bracket												
Fixed end bracket												
Inner width W (mm)	A (mm)	B (mm)	C (mm)	D (mm)	A (mm)	B (mm)	C (mm)	D (mm)	A (mm)	B (mm)	A (mm)	B (mm)
50	42	70	58	30	42	70	58	30	94	110	94	110
90	82	110	98	70	82	110	98	70	134	150	134	150
130	122	150	138	110	122	150	138	110	174	190	174	190

### Basic specifications

Maximum travel speed (m/min)	300 *1	
Operating temperature range (°C)	-40 to 80	
Materials	Link	Engineering plastic (black)
	Bracket	Steel (black finish)
	Vertical divider	Engineering plastic (black)
Standard length (No. of links)	100	

Notes: ★1. 150 m/min for support roller arrangement.  
2. Cannot be used in acidic or alkaline environments.

### Load diagram

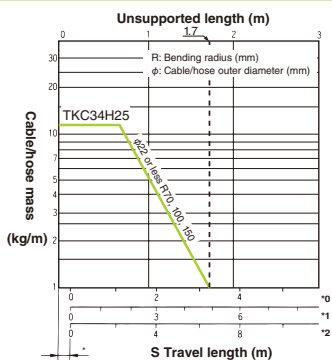

\* Includes leeway length.  
\*0: Without support rollers  
\*1: With support roller in 1 location  
\*2: With support rollers in 2 locations

Note: Use the gliding arrangement (page 127) if capacity is exceeded.

### Calculating no. of links

$$\text{Number of links} = \frac{S}{2} + \pi R + 2K$$

Note: When fixed end is at the center of the travel length. Always round up the value after calculating.

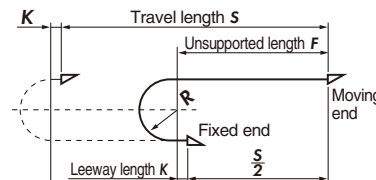

S: Travel length (mm)  
R: Bending radius (mm)  
P: Pitch = 34 mm  
K: Leeway length = 34 mm or greater

### Model number

**TKC34H25W (1) R (2) + (3) L - (4) - (5)**

(1) Inner width	(2) Bending radius	(3) Number of links	(4) Fixed end	(5) Moving end
50	70		FOA	MOA
90	100		FIA	MIA
130	150		FC	MC
			FD	MD

Notes: 1. Vertical dividers are common parts regardless of the inner width. Install dividers every 2 links. Dividers are delivered uninstalled.  
2. Refer to page 132 for model number for the gliding arrangement.  
3. When ordering a circular travel arrangement, the made-to-order content will depend on the operating conditions. Contact a Tsubaki representative for further details.  
4. Fixed end brackets are delivered uninstalled. Moving end brackets are delivered installed.

#### Vertical divider

Model number	For cable carrier model number
TKC34H25-ST	TKC34H25W■■R■■

#### Steel bracket

Model number	For cable carrier model number
TKC34H25-MOA	TKC34H25W■■R■■
TKC34H25-MIA	
TKC34H25-MC	
TKC34H25-FOA	TKC34H25W■■R■■
TKC34H25-FIA	
TKC34H25-FC	
TKC34H25W50-MD	TKC34H25W50R■■
TKC34H25W50-FD	
TKC34H25W90-MD	TKC34H25W90R■■
TKC34H25W90-FD	
TKC34H25W130-MD	TKC34H25W130R■■
TKC34H25W130-FD	

See page 15 for ordering information

See page 149 for product mass

# TKC47H36

## Structure

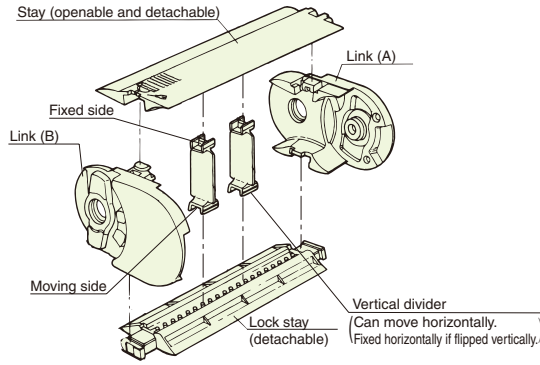

## Cross-section dimensions

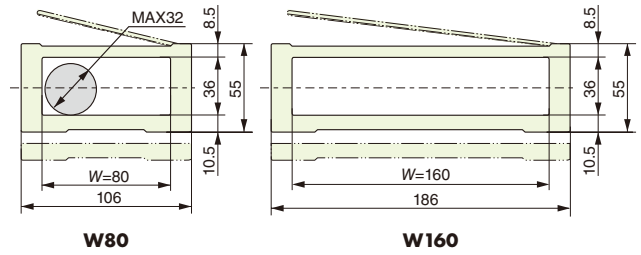

A-A arrow view

## Divider dimensions

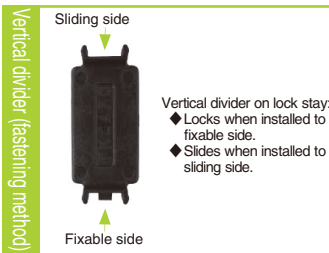
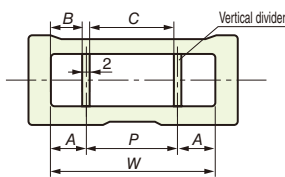

Note: Can slide between  $P$  (10 to (W-45)).  
The fastening pitch of fixable dividers is 5 mm increments.  
However, the pitch of neighboring dividers is 10 mm or greater.

Vertical divider (fastening method)	Inner width W (mm)	A (mm)	B (mm)	P (mm)	C (mm)
ST (sliding installation)	Common for all width	min22.5	min21.5	10 to (W-45)	8 to (W-47)
ST (fixable installation)	80	22.5 to 57.5	21.5 to 56.5	10 to 35	8 to 33
	160	22.5 to 137.5	21.5 to 136.5	10 to 115	8 to 113

A : Distance from center of vertical divider to end face of link  
B : Gap between vertical divider and link  
P : Distance between the centers of neighboring vertical dividers  
C : Gap between neighboring vertical dividers

Note: Make the gap between cables/ hoses and the divider or link (in the figure to right) to whichever of the following two values is larger: 2 mm or greater or the outer diameter of the cable or hose x 0.1.

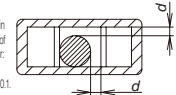

## Dimension drawings

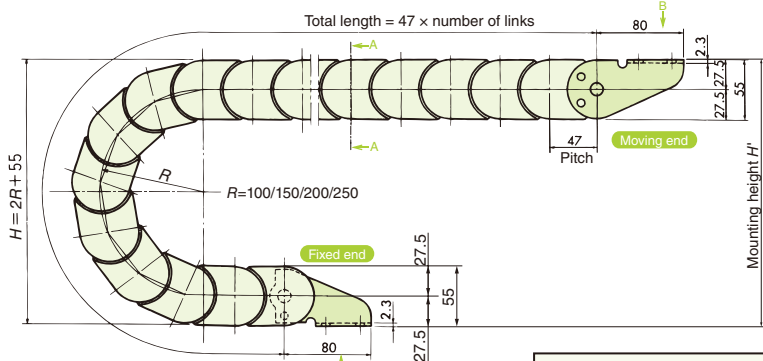

Note: Design and install according to the mounting height  $H'$  dimension.

Bending radius R (mm)	Mounting height $H'$ (mm)
100	265 to 285
150	365 to 385
200	465 to 485
250	565 to 585

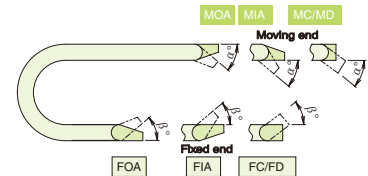

Bending radius R (mm)	Bending angle (°)	
	Moving end side ( $\alpha$ )	Fixed end side ( $\beta$ )
100	28	28
150	19	
200	14	
250	11	

## Steel bracket variants and dimensions

	Outside mounting				Inside mounting				Flange mounting		Flange mounting with cover	
	MOA				MIA				MC		MD	
Moving end bracket												
	Note: Parts differ for MIA.				Note: Parts differ for MOA.							
Fixed end bracket												
	Note: FIA are common parts.				Note: FOA are common parts.							
Inner width W (mm)	A (mm)	B (mm)	C (mm)	D (mm)	A (mm)	B (mm)	C (mm)	D (mm)	A (mm)	B (mm)	A (mm)	B (mm)
80	76	104	91	63	76	104	91	63	134	156	134	156
160	156	184	171	143	156	184	171	143	214	236	214	236

### Basic specifications

Maximum travel speed (m/min)	300 *1	
Operating temperature range (°C)	-40 to 80	
Materials	Link	Engineering plastic (black)
	Bracket	Steel (black finish)
	Vertical divider	Engineering plastic (black)
Standard length (No. of links)	80	

Notes: ★ 1. 150 m/min for support roller arrangement.  
2. Cannot be used in acidic or alkaline environments.

### Load diagram

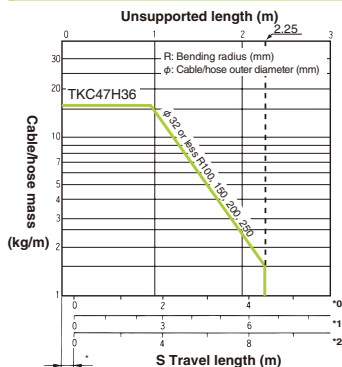

\* Includes leeway length.  
\*0: Without support rollers  
\*1: With support roller in 1 location  
\*2: With support rollers in 2 locations

Note: Use the gliding arrangement (page 127) if capacity is exceeded.

### Calculating no. of links

$$\text{Number of links} = \frac{S}{2} + \pi R + 2K$$

Note: When fixed end is at the center of the travel length. Always round up the value after calculating.

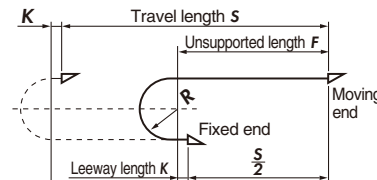

**S:** Travel length (mm)  
**R:** Bending radius (mm)  
**P:** Pitch = 47 mm  
**K:** Leeway length = 47 mm or greater

### Model number

**TKC47H36W (1) R (2) + (3) L - (4) - (5)**

(1) Inner width	(2) Bending radius	(3) Number of links	(4) Fixed end	(5) Moving end
80	100		FOA	MOA
160	150		FIA	MIA
	200		FC	MC
	250		FD	MD

Notes: 1. Vertical dividers are common parts regardless of the inner width. Install dividers every 2 links. Dividers are delivered uninstalled.  
2. Refer to page 132 for model number for the gliding arrangement.  
3. When ordering a circular travel arrangement, the made-to-order content will depend on the operating conditions. Contact a Tsubaki representative for further details.  
4. Brackets are delivered installed.

#### Vertical divider

Model number	For cable carrier model number
TKC47H36-ST	TKC47H36W ■■ R ■■

#### Steel bracket

Model number	For cable carrier model number
TKC47H36-MOA	TKC47H36W ■■ R ■■
TKC47H36-MIA	
TKC47H36-MC	
TKC47H36-FOA	TKC47H36W ■■ R ■■
TKC47H36-FIA	
TKC47H36-FC	
TKC47H36W80-MD	TKC47H36W80R ■■
TKC47H36W80-FD	
TKC47H36W160-MD	TKC47H36W160R ■■
TKC47H36W160-FD	

See page 15 for ordering information

See page 149 for product mass

# TKC64H50

## Structure

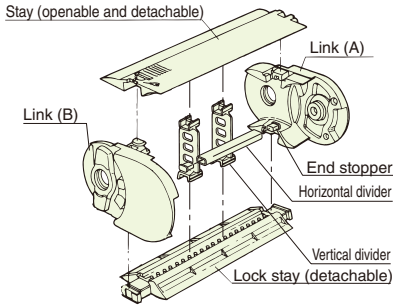

## Cross-section dimensions

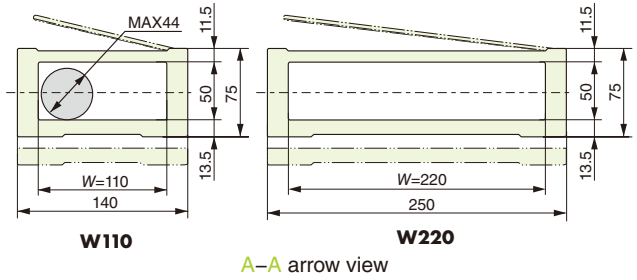

## Divider dimensions

- (1) When using only vertical dividers  
Fastening pitch = 5 when vertical divider is locked
- (2) Fully-stayed 2-layers height separation (DSA type)
- (3) Fully-stayed 3-layers height separation (DSA type)
- (4) Partial 2 or 3-layers height separation (DSB type)

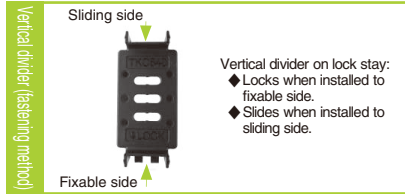
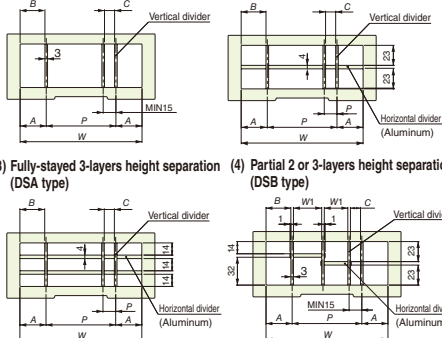

Vertical divider (fastening method)	Inner width W (mm)	A (mm)	B (mm)	P (mm)	C (mm)	W1 (mm)
ST (sliding installation)	Common for all width	min 30	min 28.5	15 to (W-60)	12 to (W-63)	12 to 122 (1 mm increments)
ST (fixable installation)	110	30 to 40 5 mm increments	28.5 to 38.5 5 mm increments	15 to 60 5 mm increments	12 to 57 5 mm increments	12 to 57 5 mm increments
	220	30 to 40 5 mm increments	28.5 to 38.5 5 mm increments	15 to 125 5 mm increments	12 to 122 5 mm increments	12 to 122 5 mm increments

A : Distance from center of vertical divider to end face of link  
 B : Gap between vertical divider and link  
 C : Gap between neighboring vertical dividers  
 P : Distance between the centers of neighboring vertical dividers

Note: Make the gap between cables/hoses and the divider or link (in the figure to right) to whichever of the following two values is larger: 2 mm or greater or the outer diameter of the cable or hose x 0.1.

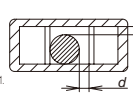

Note: The maximum values for A, B, P, and C are applied when using horizontal dividers.

## Dimension drawings

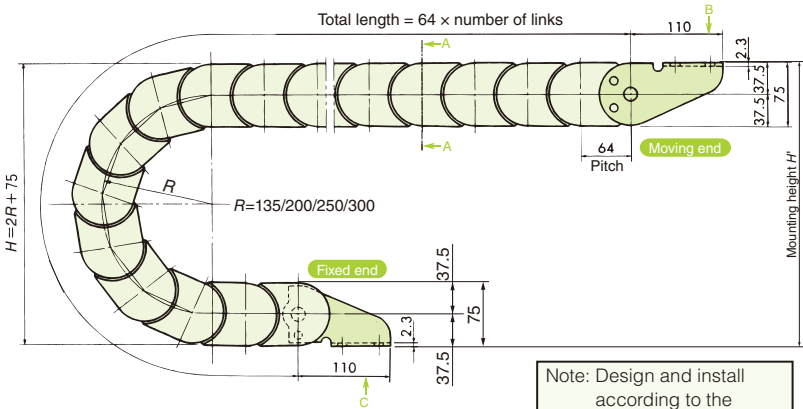

Note: Design and install according to the mounting height  $H'$  dimension.

Bending radius R (mm)	Mounting height $H'$ (mm)
135	355 to 375
200	485 to 505
250	585 to 605
300	685 to 705

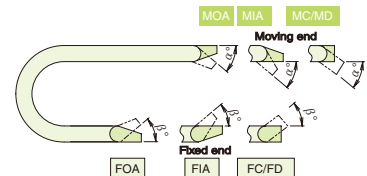

Bending radius R (mm)	Bending angle (°)	
	Moving end side ( $\alpha$ )	Fixed end side ( $\beta$ )
135	29	28
200	20	
250	16	
300	14	

## Steel bracket variants and dimensions

	Outside mounting				Inside mounting				Flange mounting		Flange mounting with cover	
	MOA				MIA				MC		MD	
Moving end bracket B arrow view												
	Note: Parts differ for MIA.				Note: Parts differ for MOA.							
Fixed end bracket C arrow view												
	Note: FIA are common parts.				Note: FOA are common parts.							
Inner width W (mm)	A (mm)	B (mm)	C (mm)	D (mm)	A (mm)	B (mm)	C (mm)	D (mm)	A (mm)	B (mm)	A (mm)	B (mm)
110	103	137	122	88	103	137	122	88	174	200	174	200
220	213	247	232	198	213	247	232	198	284	310	284	310

### Basic specifications

Maximum travel speed (m/min)		300 *1
Operating temperature range (°C)		-40 to 80
Materials	Link	Engineering plastic (black)
	Bracket	Steel (black finish)
	Vertical divider	Engineering plastic (black)
	Horizontal divider	For DSA type (HS) Aluminum For DSB type (EHS) Engineering plastic (black) + aluminum
Standard length (No. of links)		60

Notes: ★ 1. 150 m/min for support roller arrangement.  
2. Cannot be used in acidic or alkaline environments.

### Load diagram

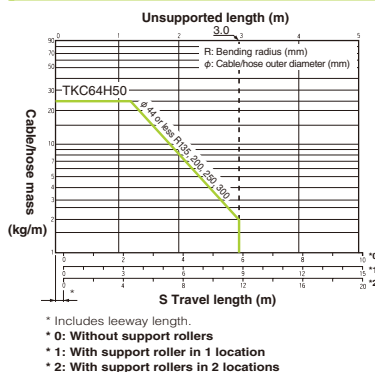

Note: Use the gliding arrangement (page 127) if capacity is exceeded.

### Calculating no. of links

$$\text{Number of links} = \frac{S}{P} + \pi R + 2K$$

Note: When fixed end is at the center of the travel length. Always round up the value after calculating.

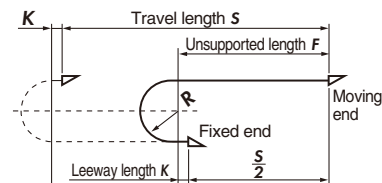

**S:** Travel length (mm)  
**R:** Bending radius (mm)  
**P:** Pitch = 64 mm  
**K:** Leeway length = 64 mm or greater

### Model number

**TKC64H50W (1) R (2) + (3) L - (4) - (5)**

(1) Inner width	(2) Bending radius	(3) Number of links	(4) Fixed end	(5) Moving end
110	135		FOA	MOA
220	200		FIA	MIA
	250		FC	MC
	300		FD	MD

Notes: 1. Vertical dividers are common parts regardless of the inner width. Install dividers every 2 links. Dividers are delivered uninstalled.  
2. Refer to page 132 for model number for the gliding arrangement.  
3. When ordering a circular travel arrangement, the made-to-order content will depend on the operating conditions. Contact a Tsubaki representative for further details.  
4. Brackets are delivered installed.

#### ■ Divider

Type	Model number	Part	Unit
(1) Vertical divider	TKC64H50-ST	1 vertical divider	K (pcs)
(2) Horizontal divider (For DSA type)	TKC64H50-HS (Dimension W) W = 110/220	1 horizontal divider	K (pcs)
(3) Horizontal divider with end stoppers (For DSB type)	TKC64H50-EHS (Dimension W1) W1 = 12 to 122: 1 mm increments	1 horizontal divider 2 end stoppers	K (pcs)

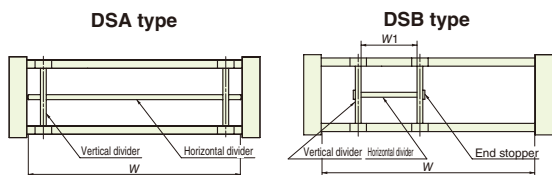

#### ■ Vertical divider

Model number	For cable carrier model number
TKC64H50-ST	TKC64H50W■■R■■

#### ■ Horizontal divider

Model number	For cable carrier model number
TKC64H50-HS110	TKC64H50W110R■■
TKC64H50-HS220	TKC64H50W220R■■

#### ■ Horizontal divider with end stoppers

Model number
TKC64H50-EHS○○

○○: Integer between 12 and 122

#### ■ Steel bracket

Model number	For cable carrier model number
TKC64H50-MOA	TKC64H50W■■R■■
TKC64H50-MIA	
TKC64H50-MC	
TKC64H50-FOA	TKC64H50W■■R■■
TKC64H50-FIA	
TKC64H50-FC	
TKC64H50W110-MD	TKC64H50W110R■■
TKC64H50W110-FD	
TKC64H50W220-MD	TKC64H50W220R■■
TKC64H50W220-FD	

See page 15 for ordering information

See page 149 for product mass

# TKC85H68

## Structure

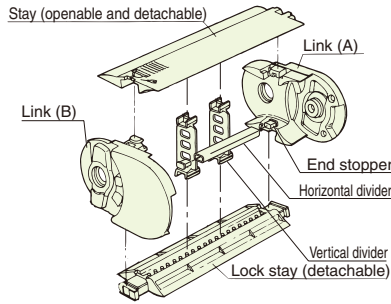

## Cross-section dimensions

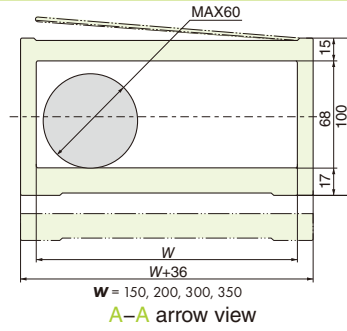

## Divider dimensions

(1) When using only vertical dividers

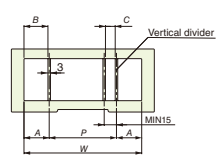

(2) Fully-stayed 2-layers height separation (DSA type)

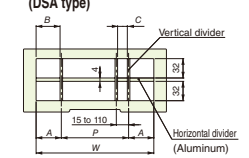

(3) Fully-stayed 3-layers height separation (DSA type)

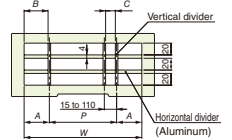

(4) Partial 2 or 3-layers height separation (DSB type)

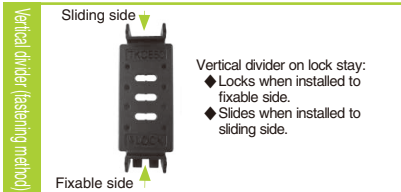
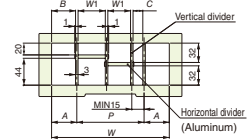

Vertical divider (fastening method)	Inner width W (mm)	A (mm)	B (mm)	P (mm)	C (mm)	W1 (mm)
ST (sliding installation)	Common for all width	min 40	min 38.5	15 to (W-80)	12 to (W-83)	12 to 107 (1 mm increments)
ST (fixable installation)	150	40	38.5	15 to 70	12 to 67	12 to 107 (5 mm increments)
	200			15 to 110	12 to 107	
	300			15 to 110	12 to 107	
	350			15 to 110	12 to 107	

A : Distance from center of vertical divider to end face of link  
 B : Gap between vertical divider and link  
 P : Distance between the centers of neighboring vertical dividers  
 C : Gap between neighboring vertical dividers

Note: Make the gap between cables/hoses and the divider on link (d) in the figure to right to whichever of the following two values is larger: 2 mm or greater or the outer diameter of the cable or hose x 0.1.

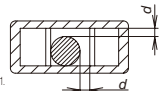

## Dimension drawings

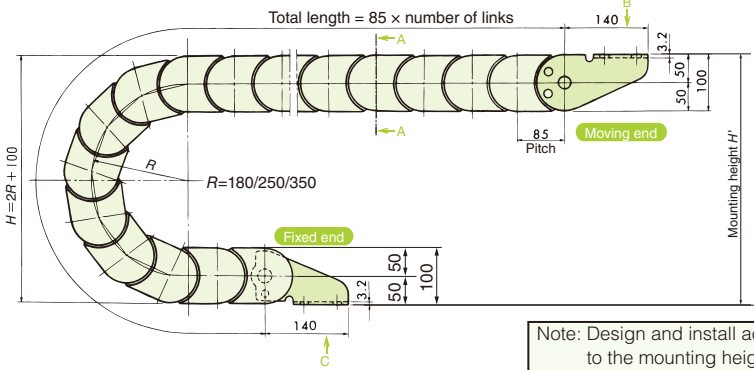

Bending radius R (mm)	Mounting height H' (mm)
180	470 to 490
250	610 to 630
350	810 to 830

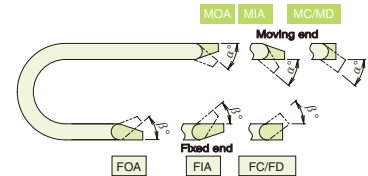

Bending radius R (mm)	Bending angle (°)	
	Moving end side (α)	Fixed end side (β)
180	28	28
250	20	
350	14	

## Steel bracket variants and dimensions

	Outside mounting				Inside mounting				Flange mounting		Flange mounting with cover	
	MOA	MIA	MC	MD	FOA	FIA	FC	FD				
Moving end bracket												
Fixed end bracket												
Inner width W (mm)	A (mm)	B (mm)	C (mm)	D (mm)	A (mm)	B (mm)	C (mm)	D (mm)	A (mm)	B (mm)	A (mm)	B (mm)
150	134	184	165	115	134	184	165	115	222	248	222	248
200	184	234	215	165	184	234	215	165	272	298	272	298
300	284	334	315	265	284	334	315	265	372	398	372	398
350	334	384	365	315	334	384	365	315	422	448	422	448



**Basic specifications**

Maximum travel speed (m/min)		300 *1
Operating temperature range (°C)		-40 to 80
Materials	Link	Engineering plastic (black)
	Bracket	Steel (black finish)
	Vertical divider	Engineering plastic (black)
	Horizontal divider	For DSA type (HS)
For DSB type (EHS)		Engineering plastic (black) + aluminum
Standard length (No. of links)		40

Notes: ★1. 150 m/min for support roller arrangement.  
2. Cannot be used in acidic or alkaline environments.

**Load diagram**

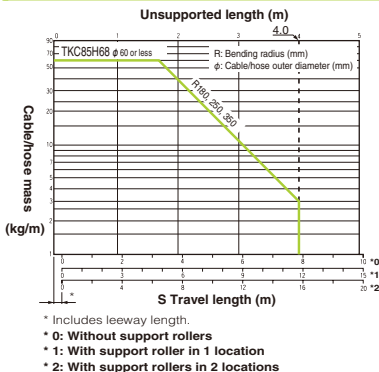

Note: Use the gliding arrangement (page 127) if capacity is exceeded.

**Calculating no. of links**

$$\text{Number of links} = \frac{S}{2} + \pi R + 2K$$

Note: When fixed end is at the center of the travel length. Always round up the value after calculating.

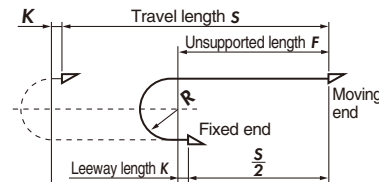

S: Travel length (mm)  
R: Bending radius (mm)  
P: Pitch = 85 mm  
K: Leeway length = 85 mm or greater

**Model number**

**TKC85H68W (1) R (2) + (3) L - (4) - (5)**

(1) Inner width	(2) Bending radius	(3) Number of links	(4) Fixed end	(5) Moving end
150	180		FOA	MOA
200	250		FIA	MIA
300	350		FC	MC
350			FD	MD

Notes: 1. Vertical dividers are common parts regardless of the inner width. Install dividers every 2 links. Dividers are delivered uninstalled.  
2. Refer to page 132 for model number for the gliding arrangement.  
3. When ordering a circular travel arrangement, the made-to-order content will depend on the operating conditions. Contact a Tsubaki representative for further details.  
4. Brackets are delivered installed.

**■ Divider**

Type	Model number	Part	Unit
(1) Vertical divider	TKC85H68-ST	1 vertical divider	K (pcs)
(2) Horizontal divider (For DSA type)	TKC85H68-HS (Dimension W) W = 150/200	1 horizontal divider	K (pcs)
(3) Horizontal divider with end stoppers (For DSB type)	TKC85H68-EHS (Dimension W1) W1 = 12 to 107: 1 mm increments	1 horizontal divider 2 end stoppers	K (pcs)

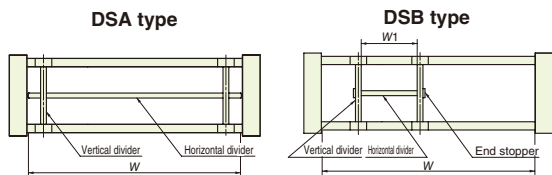

**■ Vertical divider**

Model number	For cable carrier model number
TKC85H68-ST	TKC85H68W■■R■■

**■ Horizontal divider**

Model number	For cable carrier model number
TKC85H68-HS150	TKC85H68W150R■■
TKC85H68-HS200	TKC85H68W200R■■

**■ Horizontal divider with end stoppers**

Model number
TKC85H68-EHS○○

○○: Integer between 12 and 107

**■ Steel bracket**

Model number	For cable carrier model number
TKC85H68-MOA	TKC85H68W■■R■■
TKC85H68-MIA	
TKC85H68-MC	
TKC85H68-FOA	TKC85H68W■■R■■
TKC85H68-FIA	
TKC85H68-FC	
TKC85H68W150-MD	TKC85H68W150R■■
TKC85H68W150-FD	
TKC85H68W200-MD	TKC85H68W200R■■
TKC85H68W200-FD	
TKC85H68W300-MD	TKC85H68W300R■■
TKC85H68W300-FD	
TKC85H68W350-MD	TKC85H68W350R■■
TKC85H68W350-FD	

See page 15 for ordering information

See page 149 for product mass

# TKC91H56

(Patented)

## Structure

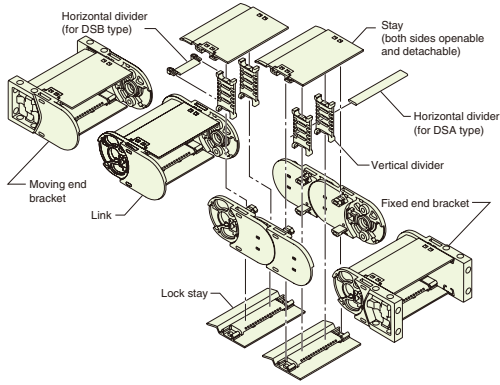

## Cross-section dimensions

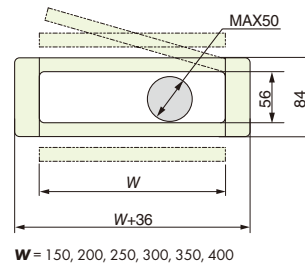

W = 150, 200, 250, 300, 350, 400

A-A arrow view

## Divider dimensions

- (1) When using only vertical dividers
- (2) Fully-stayed multiple height separation (DSA type)
- (3) Partial multiple height separation (DSB type)

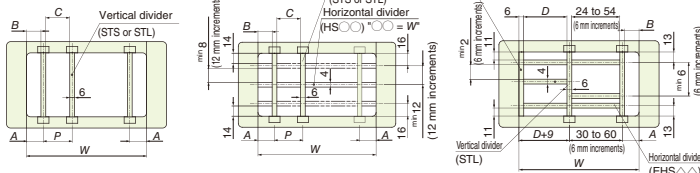

Vertical divider (fastening method)	Inner width W (mm)	A (mm)	B (mm)	P (mm)	C (mm)	D (mm)
STS (sliding installation)	Common for all widths	30 to 40	27 to 37	14 to 100	8 to 94	
STL (fixable installation)	150	33, 39	30, 36	18 to 96 (6 mm increments)	12 to 90 (6 mm increments)	24 to 54 (6 mm increments)
	200	31, 37	28, 34			22 to 52
	250	32, 38	29, 35			23 to 53
	300	30, 36	27, 33			21 to 51
	350	31, 37	28, 34			22 to 52
400	32, 38	29, 35	23 to 53			

### Notes:

- A : Distance from center of vertical divider to end face of link
- B : Gap between vertical divider and link
- P : Distance between the centers of neighboring vertical dividers
- C : Gap between neighboring vertical dividers
- D : Gap between neighboring vertical dividers when vertical dividers/dividers for both ends are installed

Note: Make the gap between cables/hoses and the divider or link (d in the figure to right) to whichever of the following two values is larger: 2 mm or greater or the outer diameter of the cable or hose x 0.1.

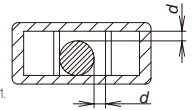

Note: The maximum values for A, B, P, C, and D are applied when using horizontal dividers.

## Dimensions & brackets



Bending radius R (mm)	Mounting height H' (mm)
200	494 to 514
250	594 to 614
300	694 to 714
350	794 to 814
400	894 to 914

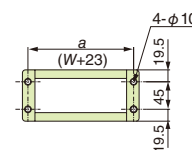
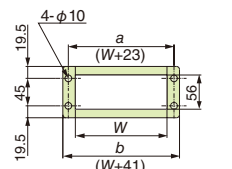
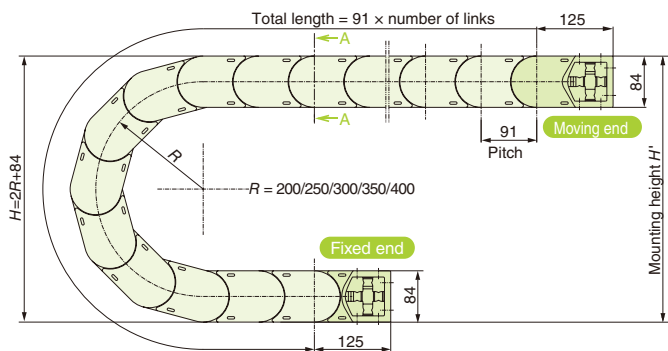

W (mm)	a (mm)	b (mm)
150	173	191
200	223	241
250	273	291
300	323	341
350	373	391
400	423	441

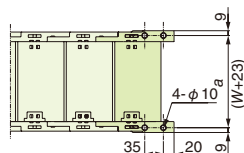
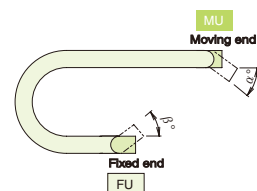

Fixed end bracket

Note: Design and install according to the mounting height H' dimension.

Bending radius R (mm)	Bending angle (°)	
	Moving end side (α)	Fixed end side (β)
200	26	35
250	20	
300	17	
350	15	
400	13	

**Basic specifications**

Maximum travel speed (m/min)		300 *1
Operating temperature range (°C)		-40 to 80
Materials	Link	Engineering plastic (black)
	Bracket	Engineering plastic (black) + steel bush
	Vertical divider	Engineering plastic (black)
	Horizontal divider	For DSA type (HS)
For DSB type (EHS)		Engineering plastic (black) + aluminum
Standard length (No. of links)		R350 or less = 20 R400 = 10

Notes: ★1. 150 m/min for support roller arrangement.  
2. Cannot be used in acidic or alkaline environments.

**Load diagram**

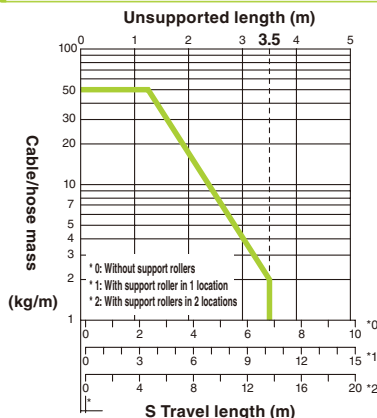

Note: Use the gliding arrangement (page 127) if capacity is exceeded.

**Calculating no. of links**

$$\text{Number of links} = \frac{S}{2} + \pi R + 2K$$

Note: When fixed end is at the center of the travel length. Always round up the value after calculating.

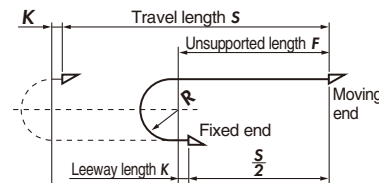

S: Travel length (mm)  
R: Bending radius (mm)  
P: Pitch = 91 mm  
K: Leeway length = 91 mm or greater

**Model number**

**TKC91H56W (1) R (2) + (3) L - (4) - (5)**

(1) Inner width	(2) Bending radius	(3) Number of links	(4) Fixed end	(5) Moving end
150	200		FU	MU
200	250		FUCR	MUCR
250	300			
300	350			
350	400			
400				

Notes: 1. Dividers are delivered uninstalled.  
2. Refer to page 132 for model number for the gliding arrangement.

**Divider**

Type	Model number
Vertical divider (sliding installation)	TKC91H56-STS
Vertical divider (fixable installation)	TKC91H56-STL
Vertical divider (for both ends)	TKC91H56-STE
Horizontal divider(for DSA type)	TKC91H56-HS○○○
Horizontal divider (for DSB type)	TKC91H56-EHS△△

○○○ = 150, 200  
△△ = Dimension C or D of divider dimensions.

**Vertical divider**

Model number	For cable carrier model number
TKC91H56-STS	TKC91H56W■■■R■■
TKC91H56-STL	
TKC91H56-STE	

**Horizontal divider**

Model number	For cable carrier model number
TKC91H56-HS150	TKC91H56W150R■■
TKC91H56-HS200	TKC91H56W200R■■

**Bracket**

Model number	For cable carrier model number
TKC91H56W150-MU	TKC91H56W150R■■
TKC91H56W150-FU	
TKC91H56W200-MU	TKC91H56W200R■■
TKC91H56W200-FU	
TKC91H56W250-MU	TKC91H56W250R■■
TKC91H56W250-FU	
TKC91H56W300-MU	TKC91H56W300R■■
TKC91H56W300-FU	
TKC91H56W350-MU	TKC91H56W350R■■
TKC91H56W350-FU	
TKC91H56W400-MU	TKC91H56W400R■■
TKC91H56W400-FU	

**Horizontal divider with end stoppers**

Model number	For cable carrier model number
TKC91H56-EHS24	TKC91H56W■■■R■■ (Common for each width)
TKC91H56-EHS30	
TKC91H56-EHS36	
TKC91H56-EHS42	
TKC91H56-EHS48	
TKC91H56-EHS54	TKC91H56W■■■R■■ (* For W = 200, 350)
TKC91H56-EHS22	
TKC91H56-EHS28	
TKC91H56-EHS34	
TKC91H56-EHS40	
TKC91H56-EHS46	TKC91H56W■■■R■■ (* For W = 250, 400)
TKC91H56-EHS52	
TKC91H56-EHS23	
TKC91H56-EHS29	
TKC91H56-EHS35	
TKC91H56-EHS41	TKC91H56W300R■■ (* For W = 300)
TKC91H56-EHS47	
TKC91H56-EHS53	
TKC91H56-EHS21	
TKC91H56-EHS27	
TKC91H56-EHS33	TKC91H56W300R■■ (* For W = 300)
TKC91H56-EHS39	
TKC91H56-EHS45	
TKC91H56-EHS51	

\* When used on vertical divider for both ends (STE).

**Bracket (with clamp rail)**

Model number	For cable carrier model number
TKC91H56W150-MUCR	TKC91H56W150R■■
TKC91H56W150-FUCR	
TKC91H56W200-MUCR	TKC91H56W200R■■
TKC91H56W200-FUCR	
TKC91H56W250-MUCR	TKC91H56W250R■■
TKC91H56W250-FUCR	
TKC91H56W300-MUCR	TKC91H56W300R■■
TKC91H56W300-FUCR	
TKC91H56W350-MUCR	TKC91H56W350R■■
TKC91H56W350-FUCR	
TKC91H56W400-MUCR	TKC91H56W400R■■
TKC91H56W400-FUCR	

See page 15 for ordering information

See page 149 for product mass

# TKC91H80

(Patented)

## Structure

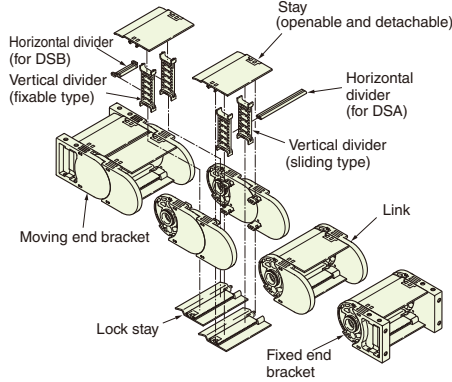

## Cross-section dimensions

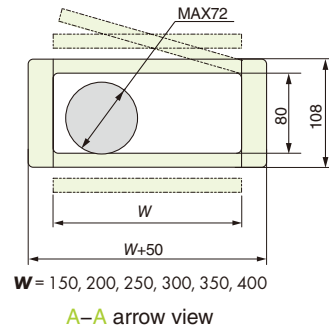

## Divider dimensions

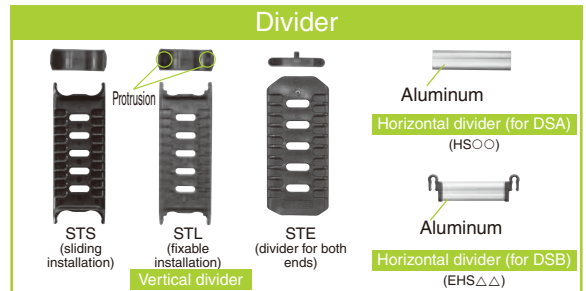
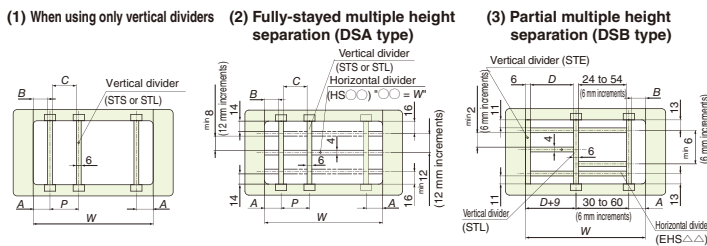

Vertical divider (fastening method)	Inner width W (mm)	A (mm)	B (mm)	P (mm)	C (mm)	D (mm)
STS (sliding installation)	Common for all widths	30 to 40	27 to 37	14 to 100	8 to 94	
STL (fixable installation)	150	33, 39	30, 36	18 to 96 (6 mm increments)	12 to 90 (6 mm increments)	24 to 54 (6 mm increments)
	200	31, 37	28, 34			22 to 52
	250	32, 38	29, 35			23 to 53
	300	30, 36	27, 33			21 to 51
	350	31, 37	28, 34			22 to 52
400	32, 38	29, 35	23 to 53			

**Notes:**

- A : Distance from center of vertical divider to end face of link
- B : Gap between vertical divider and link
- P : Distance between the centers of neighboring vertical dividers
- C : Gap between neighboring vertical dividers
- D : Gap between neighboring vertical dividers when vertical dividers/dividers for both ends are installed

Note: Make the gap between cables/hoses and the divider or link (d in the figure to right) to whichever of the following two values is larger: 2 mm or greater or the outer diameter of the cable or hose x 0.1.

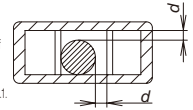

Note: The maximum values for A, B, P, C, and D are applied when using horizontal dividers.

## Dimensions & brackets

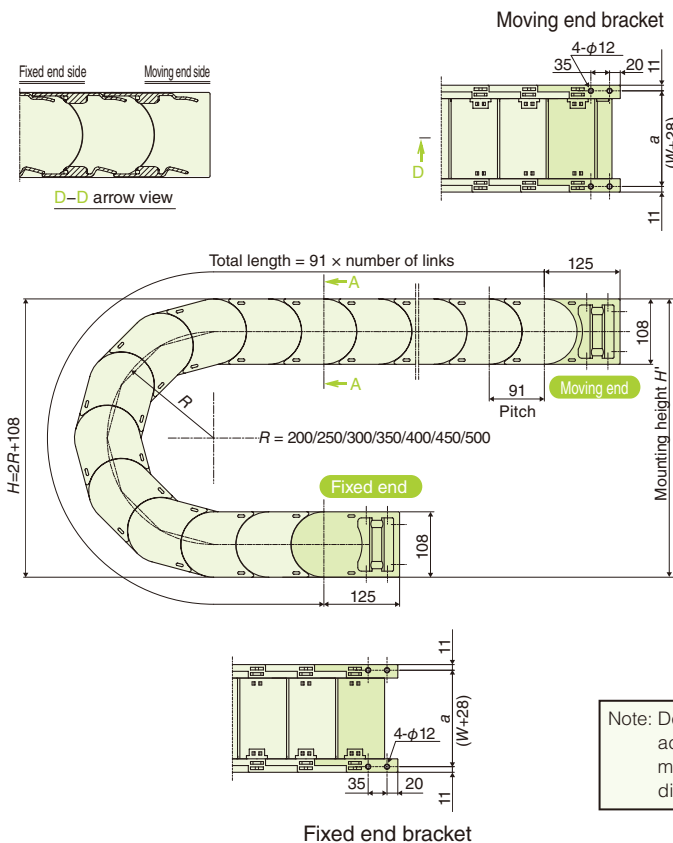

Bending radius R (mm)	Mounting height H' (mm)
200	518 to 538
250	618 to 638
300	718 to 738
350	818 to 838
400	918 to 938
450	1018 to 1038
500	1118 to 1138

W (mm)	a (mm)	b (mm)
150	178	200
200	228	250
250	278	300
300	328	350
350	378	400
400	428	450

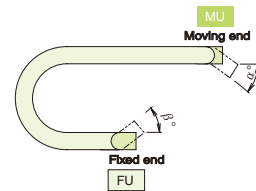

Note: Design and install according to the mounting height H' dimension.

Bending radius R (mm)	Bending angle (°)	
	Moving end side (α)	Fixed end side (β)
200	26	35
250	20	
300	17	
350	15	
400	13	
450	11	
500	10	

**Basic specifications**

Maximum travel speed (m/min)		300 **
Operating temperature range (°C)		-40 to 80
Materials	Link	Engineering plastic (black)
	Bracket	Engineering plastic (black) + steel bush
	Vertical divider	Engineering plastic (black)
	Horizontal divider	For DSA type (HS) Aluminum For DSB type (EHS) Engineering plastic (black) + aluminum
Standard length (No. of links)		R350 or less = 20 R400 to R500 = 10

Notes: ★1. 150 m/min for support roller arrangement.  
2. Cannot be used in acidic or alkaline environments.

**Load diagram**

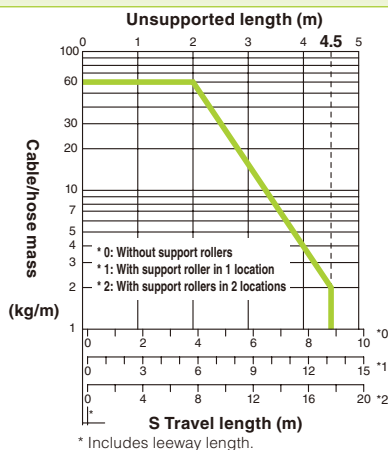

Note: Use the gliding arrangement (page 127) if capacity is exceeded.

**Calculating no. of links**

$$\text{Number of links} = \frac{S}{2} + \pi R + 2K$$

Note: When fixed end is at the center of the travel length. Always round up the value after calculating.

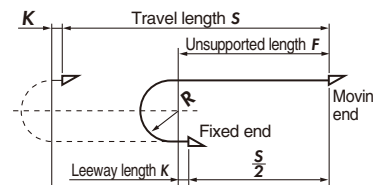

**S:** Travel length (mm)  
**R:** Bending radius (mm)  
**P:** Pitch = 91 mm  
**K:** Leeway length = 91 mm or greater

**Model number**

**TKC91H80W (1) R (2) + (3) L - (4) - (5)**

(1) Inner width	(2) Bending radius	(3) Number of links	(4) Fixed end	(5) Moving end
150	200		FU	MU
200	250		FUCR	MUCR
250	300			
300	350			
350	400			
400	450			
	500			

Notes: 1. Dividers are delivered uninstalled.  
2. Refer to page 132 for model number for the gliding arrangement.

**■ Divider**

Type	Model number
Vertical divider (sliding installation)	TKC91H80-STS
Vertical divider (fixable installation)	TKC91H80-STL
Vertical divider (for both ends)	TKC91H80-STE
Horizontal divider (for DSA type)	TKC91H80-HS○○○
Horizontal divider (for DSB type)	TKC91H80-EHS△△

○○○ = 150, 200  
△△ = Dimension C or D of divider dimensions.

**■ Vertical divider**

Model number	For cable carrier model number
TKC91H80-STS	TKC91H80W■■■R■■
TKC91H80-STL	
TKC91H80-STE	

**■ Horizontal divider**

Model number	For cable carrier model number
TKC91H80-HS150	TKC91H80W150R■■
TKC91H80-HS200	TKC91H80W200R■■

**■ Bracket**

Model number	For cable carrier model number
TKC91H80W150-MU	TKC91H80W150R■■
TKC91H80W150-FU	
TKC91H80W200-MU	TKC91H80W200R■■
TKC91H80W200-FU	
TKC91H80W250-MU	TKC91H80W250R■■
TKC91H80W250-FU	
TKC91H80W300-MU	TKC91H80W300R■■
TKC91H80W300-FU	
TKC91H80W350-MU	TKC91H80W350R■■
TKC91H80W350-FU	
TKC91H80W400-MU	TKC91H80W400R■■
TKC91H80W400-FU	

**■ Horizontal divider with end stoppers**

Model number	For cable carrier model number
TKC91H80-EHS24	TKC91H80W■■■R■■ (Common for each width)
TKC91H80-EHS30	
TKC91H80-EHS36	
TKC91H80-EHS42	
TKC91H80-EHS48	
TKC91H80-EHS54	
TKC91H80-EHS22	TKC91H80W■■■R■■ (* For W = 200, 350)
TKC91H80-EHS28	
TKC91H80-EHS34	
TKC91H80-EHS40	
TKC91H80-EHS46	
TKC91H80-EHS52	
TKC91H80-EHS23	TKC91H80W■■■R■■ (* For W = 250, 400)
TKC91H80-EHS29	
TKC91H80-EHS35	
TKC91H80-EHS41	
TKC91H80-EHS47	
TKC91H80-EHS53	
TKC91H80-EHS21	TKC91H80W300R■■ (* For W = 300)
TKC91H80-EHS27	
TKC91H80-EHS33	
TKC91H80-EHS39	
TKC91H80-EHS45	
TKC91H80-EHS51	

\* When used on vertical divider for both ends (STE).

**■ Bracket (with clamp rail)**

Model number	For cable carrier model number
TKC91H80W150-MUCR	TKC91H80W150R■■
TKC91H80W150-FUCR	
TKC91H80W200-MUCR	TKC91H80W200R■■
TKC91H80W200-FUCR	
TKC91H80W250-MUCR	TKC91H80W250R■■
TKC91H80W250-FUCR	
TKC91H80W300-MUCR	TKC91H80W300R■■
TKC91H80W300-FUCR	
TKC91H80W350-MUCR	TKC91H80W350R■■
TKC91H80W350-FUCR	
TKC91H80W400-MUCR	TKC91H80W400R■■
TKC91H80W400-FUCR	

See page 15 for ordering information

See page 149 for product mass



# Cable Carrier Steel Series

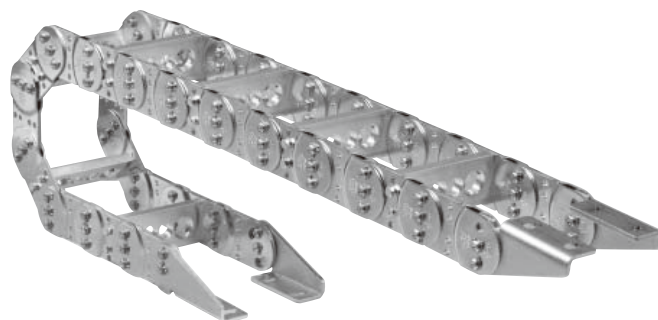

## TK Series

TK070.....	95
TK095.....	97
TK130.....	99
TK180.....	101

## TKF Series

TKF055.....	107
TKF085.....	108
TKF115.....	109
TKF175.....	110

## TKH Series

TKH250.....	103
-------------	-----

## TKV Series

TKV130.....	111
-------------	-----

## TKS Series

TKS070.....	105
TKS095.....	106

## TKI Series

TKI Series.....	112
-----------------	-----

# TK070

## Structure

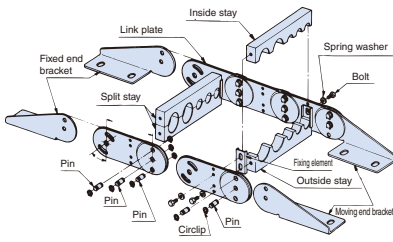

## Stay dimensions

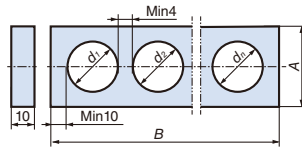

Cable/hose maximum outer diameter d (mm)	Stay maximum bore diameter (mm)	Stay height A (mm)	Stay width B (mm)								
			60	80	100	125	150	200	250	300	350
φ18	φ20	35	○	○	○	○	○	○	○	-	-
φ27	φ30	45	○	○	○	○	○	○	○	○	○

- Notes: 1. A stay width that exceeds 350 mm can also be used in certain cases. Contact a Tsubaki representative for further information.  
 2. The L-shaped fixing element type is used for a stay width that exceeds 600 mm. Refer to page 103.

## Dimension drawings/steel bracket dimensions

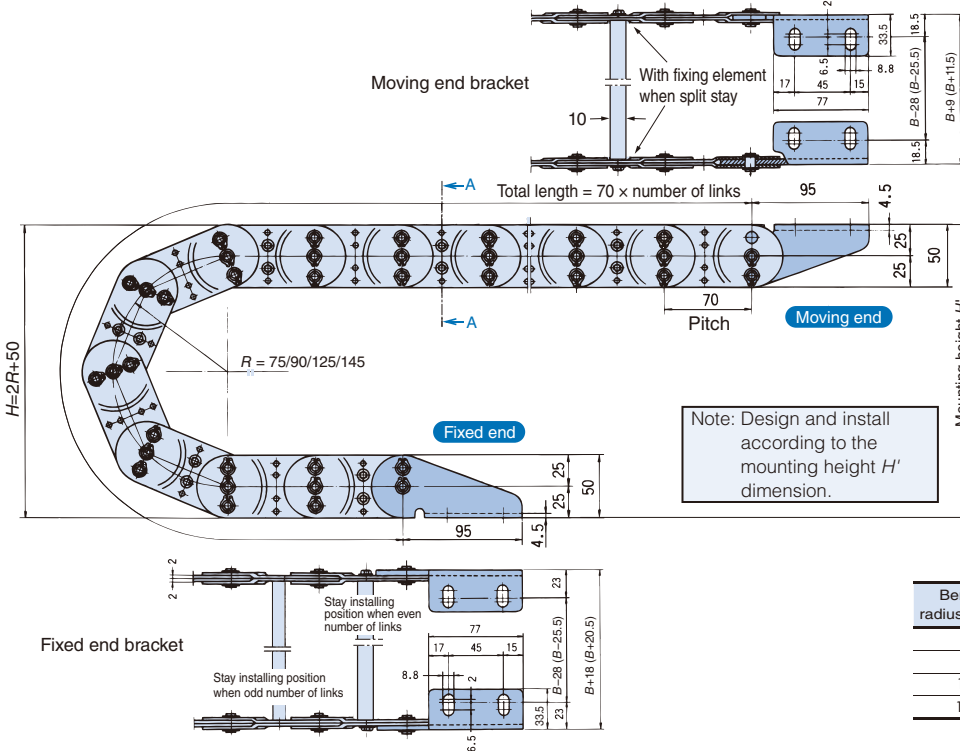

Bending radius R (mm)	Mounting height H' (mm)
75	210
90	240
125	310
145	350

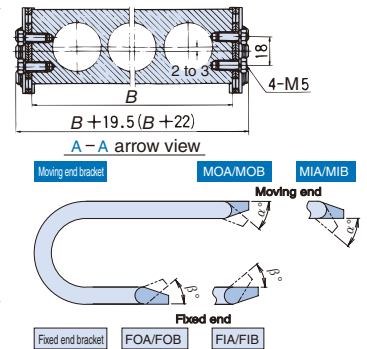

Bending radius R (mm)	Bending angle (°)	
	Moving end side (α)	Fixed end side (β)
75	0	54
90	0	45
125	0	31
145	0	27

- Notes: 1. Dimensions in ( ) are for the split stay. However, the L-shaped fixing element type is excluded.  
 2. The steel bracket can be installed in a variety of directions.  
 3. FOA, FOB, FIA, FIB, MOA, MOB, MIA, and MIB steel brackets are common parts.  
 4. Stays and steel brackets are delivered installed.

Mounting direction Direction of connection surface	Outside mounting		Inside mounting	
	Moving end bracket	Fixed end bracket	Moving end bracket	Fixed end bracket
Connection surface inside	MOA	FOA	MIA	FIA
Connection surface outside	MOB	FOB	MIB	FIB

## Basic specifications

Maximum travel speed (m/min)	60
Operating temperature range (°C)	-10 to 150
Materials	Chain (Trivalent chromate plating)
	Bracket (Trivalent chromate plating)
	Stay Aluminum
Standard length (No. of links)	50

Note: About support rollers  
 First consider the cable carrier without support rollers. If conditions/specifications are not satisfied, add the support rollers. When increasing the travel length, increasing the size can be more cost effective than adding support rollers.

## Load diagram

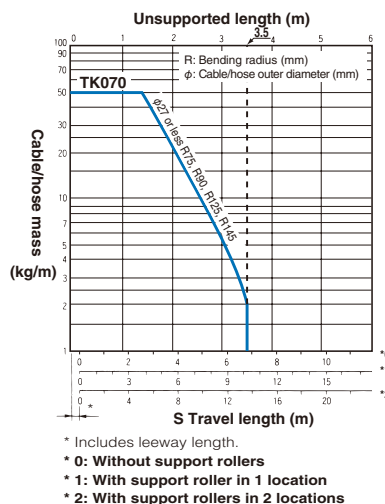

## Calculating no. of links

$$\text{Number of links} = \frac{S}{2} + \frac{\pi R}{P} + 2K$$

Note: When fixed end is at the center of the travel length. Always round up the value after calculating.

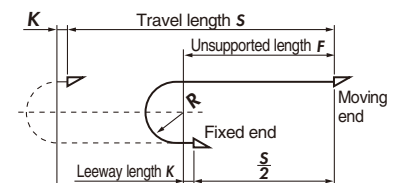

- S: Travel length (mm)
- R: Bending radius (mm)
- P: Pitch = 70 mm
- K: Leeway length = 105 mm or greater



Model number

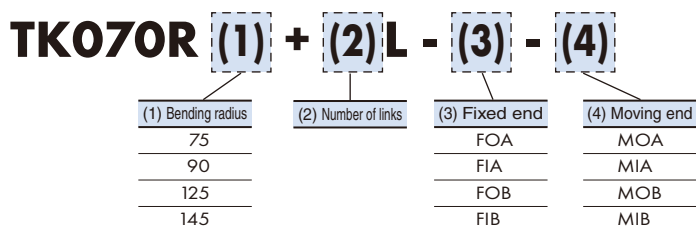

Steel bracket (including pin and circlip)

Model number	For cable carrier model number
TK070-MOA	TK070R ■■
TK070-MOB	
TK070-MIA	
TK070-MIB	
TK070-FOA	
TK070-FOB	
TK070-FIA	
TK070-FIB	

Bore dimensions

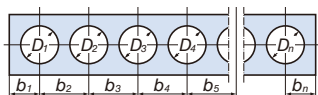

Example: Bore diameter (from left) 21/19/14/14  
Distance between stay bores (from left) 20.5/24/20.5/18/17

Bore diameter	$D_1$	$D_2$	$D_3$	$D_4$	
	21	19	14	14	
Distance between stay bores	$b_1$	$b_2$	$b_3$	$b_4$	$b_5$
	20.5	24	20.5	18	17

Note: "From left" means as viewed from the direction of the A-A arrow view in the dimensional drawing.

Stay (thickness 10 mm)

Example:  
**TK070-SP45-100-10 B-TK**

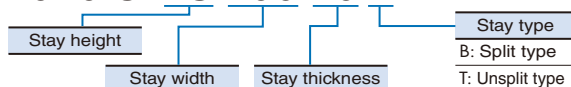

Model number	Stay height A	Stay width B	For cable carrier model number		
TK070-SP35-60-10T-TK	35	60	TK070R ■■		
TK070-SP35-60-10B-TK		80			
TK070-SP35-80-10T-TK		100			
TK070-SP35-80-10B-TK		125			
TK070-SP35-100-10T-TK		150			
TK070-SP35-100-10B-TK		200			
TK070-SP35-125-10T-TK		250			
TK070-SP35-125-10B-TK					
TK070-SP35-150-10T-TK		45		60	TK070R ■■
TK070-SP35-150-10B-TK				80	
TK070-SP35-200-10T-TK				100	
TK070-SP35-200-10B-TK				125	
TK070-SP35-250-10T-TK				150	
TK070-SP35-250-10B-TK				200	
TK070-SP45-60-10T-TK	250				
TK070-SP45-60-10B-TK	300				
TK070-SP45-80-10T-TK	350				
TK070-SP45-80-10B-TK					

See page 20 for ordering information  
See page 150 for product mass

# TK095

## Structure

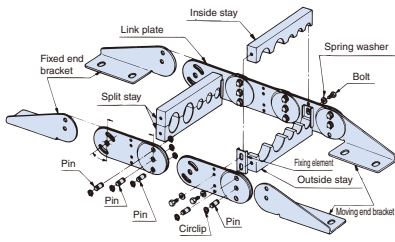

## Stay dimensions

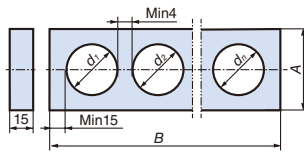

Cable/hose maximum outer diameter d (mm)	Stay maximum bore diameter (mm)	Stay height A (mm)	Stay width B (mm)										
			80	100	125	150	200	250	300	350	400	450	500
φ31	φ35	50	○	○	○	○	○	○	○	○	○	-	-
φ46	φ50	65	○	○	○	○	○	○	○	○	○	○	○

Notes: 1. A stay width that exceeds 500 mm can also be used in certain cases. Contact a Tsubaki representative for further information.  
2. The L-shaped fixing element type is used for a stay width that exceeds 600 mm. Refer to page 103.

## Dimension drawings/steel bracket dimensions

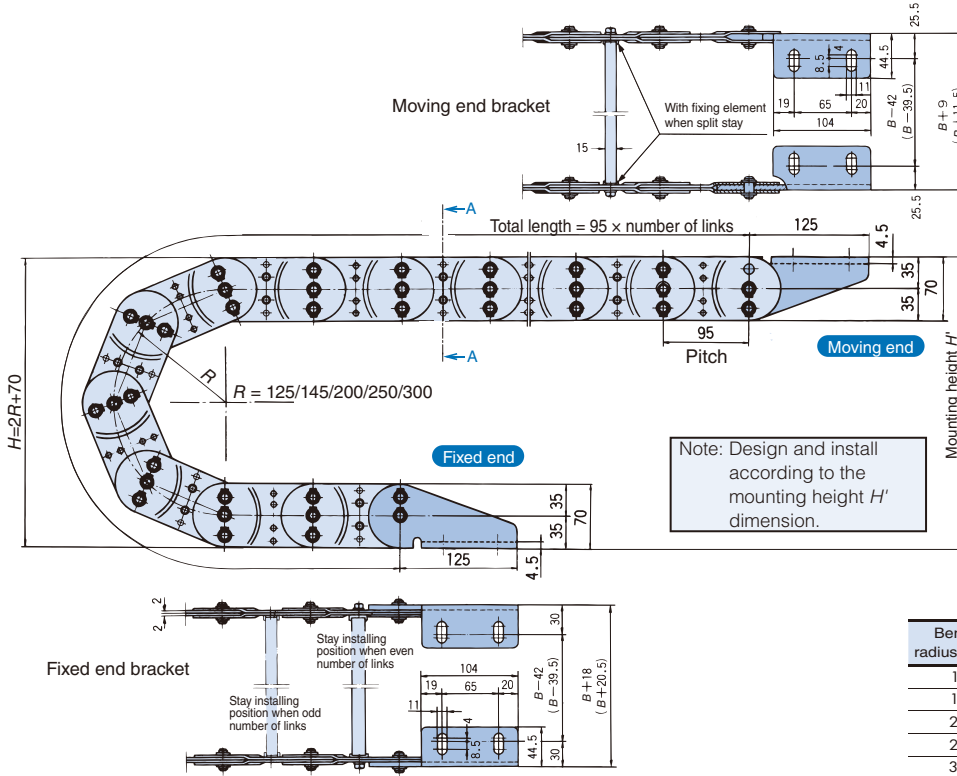

Bending radius R (mm)	Mounting height H' (mm)
125	330
145	370
200	480
250	580
300	680

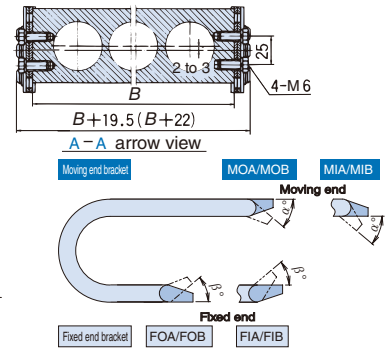

Bending radius R (mm)	Bending angle (°)	
	Moving end side (α)	Fixed end side (β)
125	0	44
145	0	37
200	0	26
250	0	21
300	0	17

Mounting direction Direction of connection surface	Outside mounting		Inside mounting	
	Moving end bracket	Fixed end bracket	Moving end bracket	Fixed end bracket
Connection surface inside	MOA	FOA	MIA	FIA
Connection surface outside	MOB	FOB	MIB	FIB

Notes: 1. Dimensions in ( ) are for the split stay. However, the L-shaped fixing element type is excluded.  
2. The steel bracket can be installed in a variety of directions.  
3. FOA, FOB, FIA, FIB, MOA, MOB, MIA, and MIB steel brackets are common parts.  
4. Stays and steel brackets are delivered installed.

## Basic specifications

Maximum travel speed (m/min)	60
Operating temperature range (°C)	-10 to 150
Materials	Chain (Trivalent chromate plating)
	Bracket (Trivalent chromate plating)
	Stay Aluminum
Standard length (No. of links)	25

**Note:** About support rollers  
First consider the cable carrier without support rollers. If conditions/specifications are not satisfied, add the support rollers. When increasing the travel length, increasing the size can be more cost effective than adding support rollers.

## Load diagram

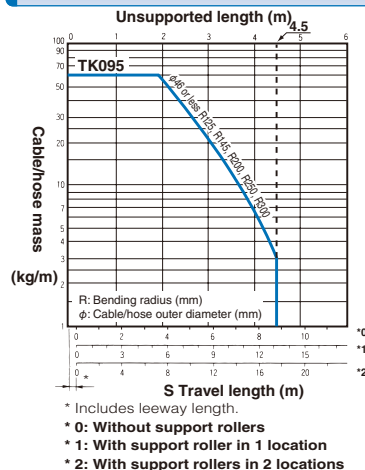

## Calculating no. of links

$$\text{Number of links} = \frac{S}{2} + \frac{\pi R}{P} + \frac{2K}{P}$$

Note: When fixed end is at the center of the travel length. Always round up the value after calculating.

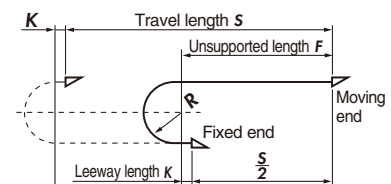

**S:** Travel length (mm)  
**R:** Bending radius (mm)  
**P:** Pitch = 95 mm  
**K:** Leeway length = 145 mm or greater

Model number

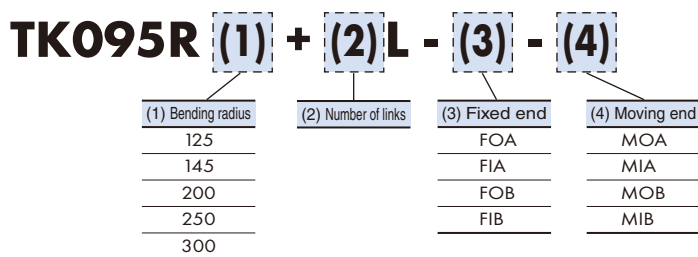

■ Steel bracket (including pin and circlip)

Model number	For cable carrier model number
TK095-MOA	TK095R ■■
TK095-MOB	
TK095-MIA	
TK095-MIB	
TK095-FOA	
TK095-FOB	
TK095-FIA	
TK095-FIB	

■ Bore dimensions

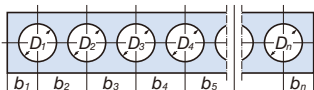

Example: Bore diameter (from left) 20/20/20/20  
Distance between stay bores (from left) 25/25/25/25/25

	$D_1$	$D_2$	$D_3$	$D_4$	
Bore diameter	20	20	20	20	
Distance between stay bores	$b_1$	$b_2$	$b_3$	$b_4$	$b_5$
	25	25	25	25	25

Note: "From left" means as viewed from the direction of the A-A arrow view in the dimensional drawing.

■ Stay (thickness 15 mm)

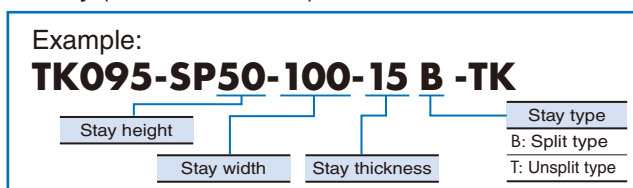

Model number	Stay height A	Stay width B	For cable carrier model number		
TK095-SP50-80-15T-TK	50	80	TK095R ■■		
TK095-SP50-80-15B-TK		100			
TK095-SP50-100-15T-TK		125			
TK095-SP50-100-15B-TK		150			
TK095-SP50-125-15T-TK		200			
TK095-SP50-125-15B-TK		250			
TK095-SP50-150-15T-TK		300			
TK095-SP50-150-15B-TK		350			
TK095-SP50-200-15T-TK		400			
TK095-SP50-200-15B-TK		65		80	TK095R ■■
TK095-SP50-250-15T-TK				100	
TK095-SP50-250-15B-TK				125	
TK095-SP50-300-15T-TK				150	
TK095-SP50-300-15B-TK				200	
TK095-SP50-350-15T-TK	250				
TK095-SP50-350-15B-TK	300				
TK095-SP50-400-15T-TK	350				
TK095-SP50-400-15B-TK	400				
TK095-SP65-80-15T-TK	450				
TK095-SP65-80-15B-TK	500				
TK095-SP65-100-15T-TK					
TK095-SP65-100-15B-TK					
TK095-SP65-125-15T-TK					
TK095-SP65-125-15B-TK					
TK095-SP65-150-15T-TK					
TK095-SP65-150-15B-TK					
TK095-SP65-200-15T-TK					
TK095-SP65-200-15B-TK					
TK095-SP65-250-15T-TK					
TK095-SP65-250-15B-TK					
TK095-SP65-300-15T-TK					
TK095-SP65-300-15B-TK					
TK095-SP65-350-15T-TK					
TK095-SP65-350-15B-TK					
TK095-SP65-400-15T-TK					
TK095-SP65-400-15B-TK					
TK095-SP65-450-15T-TK					
TK095-SP65-450-15B-TK					
TK095-SP65-500-15T-TK					
TK095-SP65-500-15B-TK					

See page 20 for ordering information

See page 150 for product mass

# TK130

## Structure

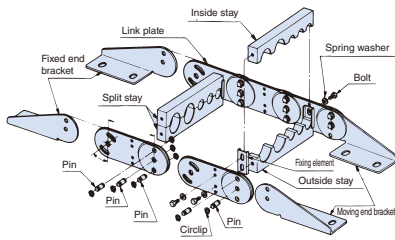

## Stay dimensions

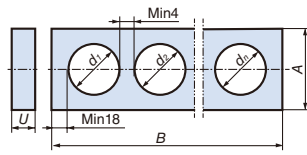

Cable/hose maximum outer diameter d (mm)	Stay maximum bore diameter (mm)	Stay height A (mm)	Stay width B (mm)												
			100	125	150	200	250	300	350	400	450	500	550	600	
φ46	φ50	65	○	○	○	○	○	○	○	○	○	○	○	-	-
φ55	φ60	75	○	○	○	○	○	○	○	○	△	△	-	-	
φ60	φ66	90	○	○	○	○	○	○	○	○	△	△	△	△	

○: Thickness U = 15 mm and 20 mm can be supported

△: Thickness U = 20 mm can be supported only

Notes: 1. A stay width that exceeds 600 mm can also be used in certain cases. Contact a Tsubaki representative for further information.

2. The L-shaped fixing element type is used for a stay width that exceeds 600 mm. Refer to page 103.

## Dimension drawings/steel bracket dimensions

Bending radius R (mm)	Mounting height H' (mm)
200	506
250	606
300	706
400	906

Bending radius R (mm)	Bending angle (°)	
	Moving end side (α)	Fixed end side (β)
200	0	37
250	0	29
300	0	24
400	0	18

Note: Design and install according to the mounting height H' dimension.

Mounting direction Direction of connection surface	Outside mounting		Inside mounting	
	Moving end bracket	Fixed end bracket	Moving end bracket	Fixed end bracket
Connection surface inside	MOA	FOA	MIA	FIA
Connection surface outside	MOB	FOB	MIB	FIB

- Notes: 1. Dimensions in ( ) are for the split stay. However, the L-shaped fixing element type is excluded.  
 2. The steel bracket can be installed in a variety of directions.  
 3. FOA, FOB, FIA, FIB, MOA, MOB, MIA, and MIB steel brackets are common parts.  
 4. Stays and steel brackets are delivered installed.

## Basic specifications

Maximum travel speed (m/min)	60		
Operating temperature range (°C)	-10 to 150		
Materials	Chain	Steel (Trivalent chromate plating)	
	Bracket	Steel (Trivalent chromate plating)	
	Stay	Aluminum	
Standard length (No. of links)	R300 or less = 19	R400 or more = 13	

Note: About support rollers

First consider the cable carrier without support rollers. If conditions/specifications are not satisfied, add the support rollers. When increasing the travel length, increasing the size can be more cost effective than adding support rollers.

## Load diagram

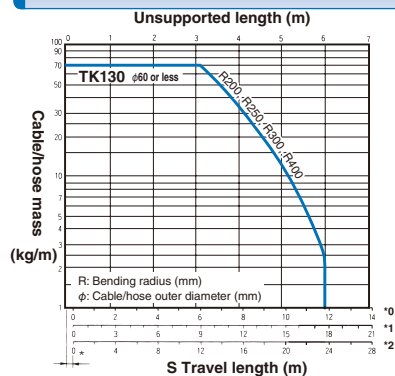

- \* Includes leeway length.
- \* 0: Without support rollers
- \* 1: With support roller in 1 location
- \* 2: With support rollers in 2 locations

## Calculating no. of links

$$\text{Number of links} = \frac{S}{P} + \pi R + 2K$$

Note: When fixed end is at the center of the travel length. Always round up the value after calculating.

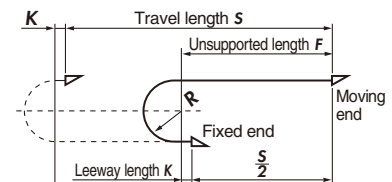

- S: Travel length (mm)
- R: Bending radius (mm)
- P: Pitch = 130 mm
- K: Leeway length = 195 mm or greater

Model number

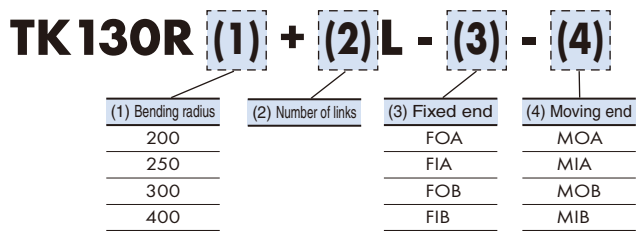

■ Steel bracket (including pin and circlip)

Model number	For cable carrier model number
TK130-MOA	TK130R ■■
TK130-MOB	
TK130-MIA	
TK130-MIB	
TK130-FOA	
TK130-FOB	
TK130-FIA	
TK130-FIB	

■ Stay

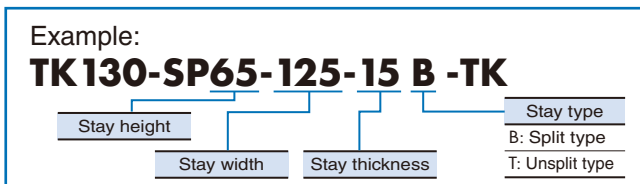

■ Stay (thickness 20 mm)

Model number	Stay height A	Stay width B	For cable carrier model number		
TK130-SP65-100-20T-TK	65	100	TK130R ■■		
TK130-SP65-100-20B-TK		125			
TK130-SP65-125-20T-TK		150			
TK130-SP65-125-20B-TK		200			
TK130-SP65-150-20T-TK		250			
TK130-SP65-150-20B-TK		300			
TK130-SP65-200-20T-TK		350			
TK130-SP65-200-20B-TK		400			
TK130-SP65-250-20T-TK		450			
TK130-SP65-250-20B-TK		500			
TK130-SP75-100-20T-TK		75		100	TK130R ■■
TK130-SP75-100-20B-TK				125	
TK130-SP75-125-20T-TK	150				
TK130-SP75-125-20B-TK	200				
TK130-SP75-150-20T-TK	250				
TK130-SP75-150-20B-TK	300				
TK130-SP75-200-20T-TK	350				
TK130-SP75-200-20B-TK	400				
TK130-SP75-250-20T-TK	450				
TK130-SP75-250-20B-TK	500				
TK130-SP90-100-20T-TK	90		100	TK130R ■■	
TK130-SP90-100-20B-TK			125		
TK130-SP90-125-20T-TK		150			
TK130-SP90-125-20B-TK		200			
TK130-SP90-150-20T-TK		250			
TK130-SP90-150-20B-TK		300			
TK130-SP90-200-20T-TK		350			
TK130-SP90-200-20B-TK		400			
TK130-SP90-250-20T-TK		450			
TK130-SP90-250-20B-TK		500			
TK130-SP90-300-20T-TK		550			
TK130-SP90-300-20B-TK		600			

■ Stay (thickness 15 mm)

Model number	Stay height A	Stay width B	For cable carrier model number		
TK130-SP65-100-15T-TK	65	100	TK130R ■■		
TK130-SP65-100-15B-TK		125			
TK130-SP65-125-15T-TK		150			
TK130-SP65-125-15B-TK		200			
TK130-SP65-150-15T-TK		250			
TK130-SP65-150-15B-TK		300			
TK130-SP65-200-15T-TK		350			
TK130-SP65-200-15B-TK		400			
TK130-SP65-250-15T-TK		450			
TK130-SP65-250-15B-TK		500			
TK130-SP75-100-15T-TK		75		100	TK130R ■■
TK130-SP75-100-15B-TK				125	
TK130-SP75-125-15T-TK	150				
TK130-SP75-125-15B-TK	200				
TK130-SP75-150-15T-TK	250				
TK130-SP75-150-15B-TK	300				
TK130-SP75-200-15T-TK	350				
TK130-SP75-200-15B-TK	400				
TK130-SP75-250-15T-TK					
TK130-SP75-250-15B-TK					
TK130-SP90-100-15T-TK	90		100	TK130R ■■	
TK130-SP90-100-15B-TK			125		
TK130-SP90-125-15T-TK		150			
TK130-SP90-125-15B-TK		200			
TK130-SP90-150-15T-TK		250			
TK130-SP90-150-15B-TK		300			
TK130-SP90-200-15T-TK		350			
TK130-SP90-200-15B-TK		400			
TK130-SP90-250-15T-TK					
TK130-SP90-250-15B-TK					

■ Bore dimensions

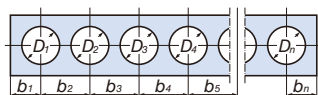

Example: Bore diameter (from left) 20/16/16/20  
Distance between stay bores (from left) 28/23/23/23/28

Bore diameter	D <sub>1</sub>	D <sub>2</sub>	D <sub>3</sub>	D <sub>4</sub>	
	20	16	16	20	
Distance between stay bores	b <sub>1</sub>	b <sub>2</sub>	b <sub>3</sub>	b <sub>4</sub>	b <sub>5</sub>
	28	23	23	23	28

Note: "From left" means as viewed from the direction of the A-A arrow view in the dimensional drawing.

See page 20 for ordering information

See page 150 for product mass

# TK180

## Structure (for reference)

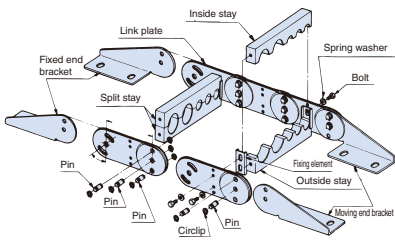

## Stay dimensions

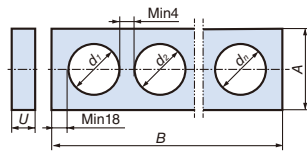

Cable/hose maximum outer diameter d (mm)	Stay maximum bore diameter (mm)	Stay height A (mm)	Stay width B (mm)											
			125	150	200	250	300	350	400	450	500	550	600	
φ55	φ60	75	○	○	○	○	○	○	○	△	△	-	-	-
φ60	φ66	90	○	○	○	○	○	○	○	△	△	△	△	△
φ80	φ88	110	△	△	△	△	△	△	△	△	△	△	△	△

○: Thickness U = 15 mm and 20 mm can be supported  
 △: Thickness U = 20 mm can be supported only

- Notes: 1. A stay width that exceeds 600 mm can also be used in certain cases. Contact a Tsubaki representative for further information.  
 2. The L-shaped fixing element type is used for a stay width that exceeds 600 mm. Refer to page 103.

## Dimension drawings/steel bracket dimensions

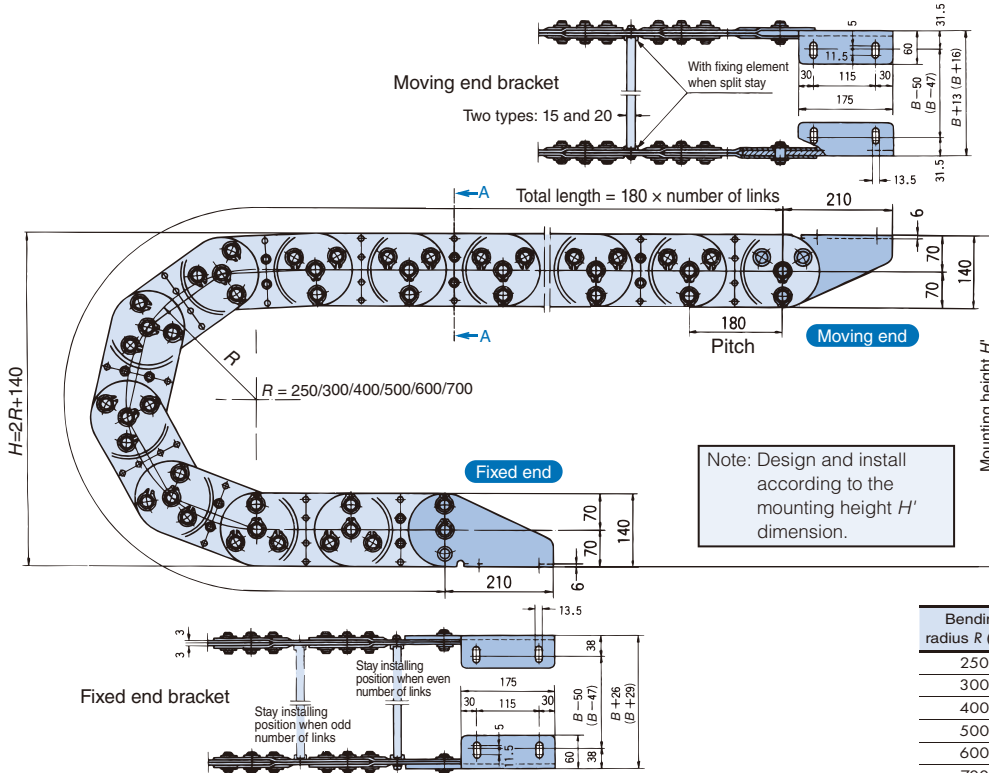

Bending radius R (mm)	Mounting height H' (mm)
250	650
300	750
400	950
500	1150
600	1350
700	1550

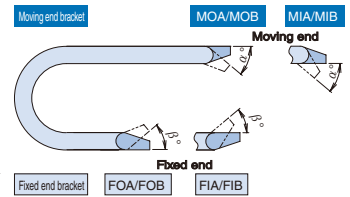
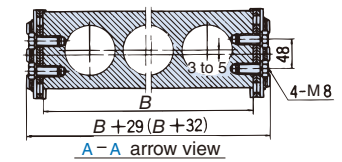

Bending radius R (mm)	Bending angle (°)	
	Moving end side (α)	Fixed end side (β)
250	0	41
300	0	34
400	0	25
500	0	20
600	0	16
700	0	14

Note: Design and install according to the mounting height H' dimension.

Mounting direction	Outside mounting		Inside mounting	
	Moving end bracket	Fixed end bracket	Moving end bracket	Fixed end bracket
Connection surface inside	MOA	FOA	MIA	FIA
Connection surface outside	MOB	FOB	MIB	FIB

- Notes: 1. Dimensions in ( ) are for the split stay. However, the L-shaped fixing element type is excluded.  
 2. The steel bracket can be installed in a variety of directions.  
 3. FOA, FOB, FIA, FIB, MOA, MOB, MIA, and MIB steel brackets are common parts.  
 4. Stays and steel brackets are delivered installed.

## Basic specifications

Maximum travel speed (m/min)	60	
Operating temperature range (°C)	-10 to 150	
Materials	Chain (Trivalent chromate plating)	Steel
	Bracket (Trivalent chromate plating)	Steel
	Stay	Aluminum
Standard length (No. of links)	R300 or less = 12 R400 or more = 9	

Note: About support rollers  
 First consider the cable carrier without support rollers. If conditions/specifications are not satisfied, add the support rollers. When increasing the travel length, increasing the size can be more cost effective than adding support rollers.

## Load diagram

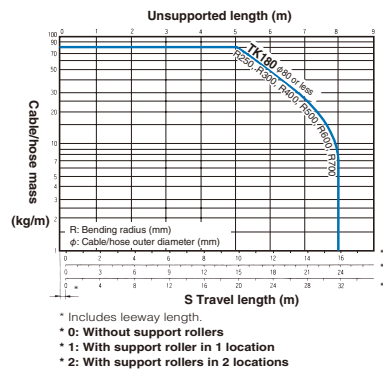

## Calculating no. of links

$$\text{Number of links} = \frac{S}{2} + \frac{\pi R}{P} + \frac{2K}{P}$$

Note: When fixed end is at the center of the travel length. Always round up the value after calculating.

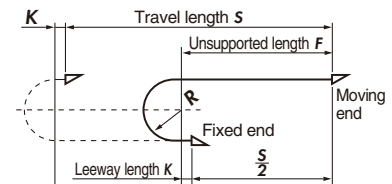

- S: Travel length (mm)
- R: Bending radius (mm)
- P: Pitch = 180 mm
- K: Leeway length = 270 mm or greater

Model number

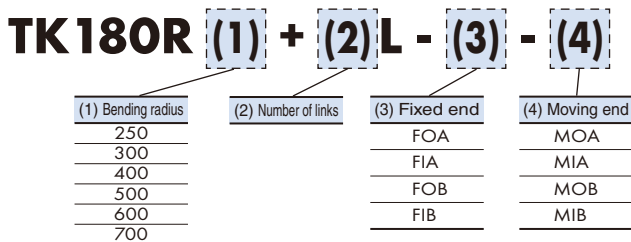

■ Steel bracket (including pin and circlip)

Model number	For cable carrier model number
TK180-MOA	TK180R ■■
TK180-MOB	
TK180-MIA	
TK180-MIB	
TK180-FOA	
TK180-FOB	
TK180-FIA	
TK180-FIB	

■ Stay

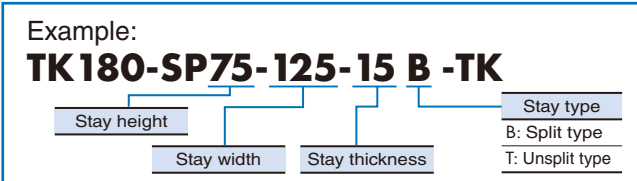

■ Stay (thickness 20 mm)

Model number	Stay height A	Stay width B	For cable carrier model number		
TK180-SP75-125-20T-TK	75	125	TK180R ■■		
TK180-SP75-125-20B-TK					
TK180-SP75-150-20T-TK				150	
TK180-SP75-150-20B-TK					
TK180-SP75-200-20T-TK					200
TK180-SP75-200-20B-TK					
TK180-SP75-250-20T-TK					
TK180-SP75-250-20B-TK					
TK180-SP75-300-20T-TK		300			
TK180-SP75-300-20B-TK					
TK180-SP75-350-20T-TK				350	
TK180-SP75-350-20B-TK					
TK180-SP75-400-20T-TK					400
TK180-SP75-400-20B-TK					
TK180-SP75-450-20T-TK	450				
TK180-SP75-450-20B-TK					
TK180-SP75-500-20T-TK		500			
TK180-SP75-500-20B-TK					
TK180-SP90-125-20T-TK				90	
TK180-SP90-125-20B-TK					
TK180-SP90-150-20T-TK					150
TK180-SP90-150-20B-TK					
TK180-SP90-200-20T-TK	200				
TK180-SP90-200-20B-TK					
TK180-SP90-250-20T-TK		250			
TK180-SP90-250-20B-TK					
TK180-SP90-300-20T-TK					
TK180-SP90-300-20B-TK					
TK180-SP90-350-20T-TK			350		
TK180-SP90-350-20B-TK					
TK180-SP90-400-20T-TK	400				
TK180-SP90-400-20B-TK					
TK180-SP90-450-20T-TK		450			
TK180-SP90-450-20B-TK					
TK180-SP90-500-20T-TK				500	
TK180-SP90-500-20B-TK					
TK180-SP90-550-20T-TK			550		
TK180-SP90-550-20B-TK					
TK180-SP90-600-20T-TK	600				
TK180-SP90-600-20B-TK					
TK180-SP110-125-20T-TK		110			125
TK180-SP110-125-20B-TK					
TK180-SP110-150-20T-TK				150	
TK180-SP110-150-20B-TK					
TK180-SP110-200-20T-TK			200		
TK180-SP110-200-20B-TK					
TK180-SP110-250-20T-TK	250				
TK180-SP110-250-20B-TK					
TK180-SP110-300-20T-TK					300
TK180-SP110-300-20B-TK					
TK180-SP110-350-20T-TK				350	
TK180-SP110-350-20B-TK					
TK180-SP110-400-20T-TK			400		
TK180-SP110-400-20B-TK					
TK180-SP110-450-20T-TK	450				
TK180-SP110-450-20B-TK					
TK180-SP110-500-20T-TK		500			
TK180-SP110-500-20B-TK					
TK180-SP110-550-20T-TK				550	
TK180-SP110-550-20B-TK					
TK180-SP110-600-20T-TK			600		
TK180-SP110-600-20B-TK					

■ Stay (thickness 15 mm)

Model number	Stay height A	Stay width B	For cable carrier model number		
TK180-SP75-125-15T-TK	75	125	TK180R ■■		
TK180-SP75-125-15B-TK					
TK180-SP75-150-15T-TK				150	
TK180-SP75-150-15B-TK					
TK180-SP75-200-15T-TK					200
TK180-SP75-200-15B-TK					
TK180-SP75-250-15T-TK					
TK180-SP75-250-15B-TK					
TK180-SP75-300-15T-TK		300			
TK180-SP75-300-15B-TK					
TK180-SP75-350-15T-TK				350	
TK180-SP75-350-15B-TK					
TK180-SP75-400-15T-TK					400
TK180-SP75-400-15B-TK					
TK180-SP90-125-15T-TK	90				
TK180-SP90-125-15B-TK					
TK180-SP90-150-15T-TK		150			
TK180-SP90-150-15B-TK					
TK180-SP90-200-15T-TK				200	
TK180-SP90-200-15B-TK					
TK180-SP90-250-15T-TK					250
TK180-SP90-250-15B-TK					
TK180-SP90-300-15T-TK					
TK180-SP90-300-15B-TK					
TK180-SP90-350-15T-TK		350			
TK180-SP90-350-15B-TK					
TK180-SP90-400-15T-TK				400	
TK180-SP90-400-15B-TK					

■ Bore dimensions

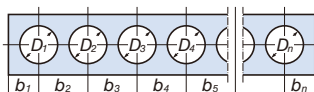

Example: Bore diameter (from left) 15/23/23/16  
Distance between stay bores (from left) 25.5/23/27/23.5/26

Bore diameter	$D_1$	$D_2$	$D_3$	$D_4$	
	15	23	23	16	
Distance between stay bores	$b_1$	$b_2$	$b_3$	$b_4$	$b_5$
	25.5	23	27	23.5	26

Note: "From left" means as viewed from the direction of the A-A arrow view in the dimensional drawing.

# TKH250

## Structure

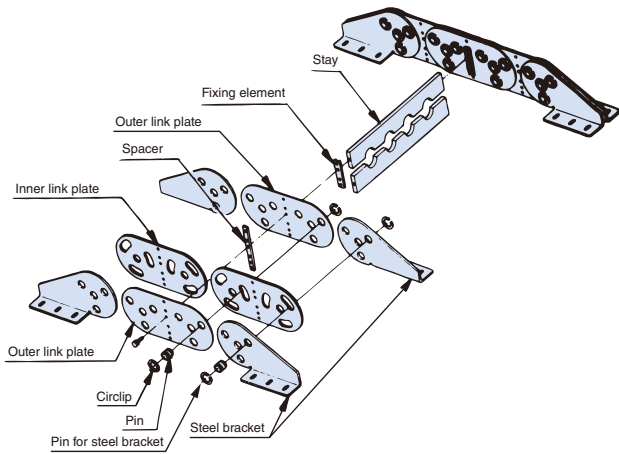

## Stay dimensions

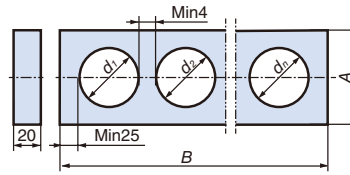

Bending radius R (mm)	Stay width B (mm)					
	350	400	450	500	550	600
350	○	○	○	○	○	○
450	○	○	○	○	○	○
600	-	○	○	○	○	○
750	-	-	○	○	○	○

Cable/hose maximum outer diameter d (mm)	Stay maximum bore diameter (mm)	Stay height A (mm)
φ60	φ66	90
φ80	φ88	110
φ110	φ121	150
Exceeds φ110	Contact a Tsubaki representative for further information.	

- Notes:
- The TKH Series is suited to low operating frequencies with long travel lengths, large cable/hose diameters, and/or heavy loads. The TKI and TKV Series are recommended for high operating frequencies.
  - In the following cases, install reinforcement bars alternately with stays.
    - When using support rollers
    - When stay height  $A = 90$
    - When stay width  $B < 350$
    - Reinforcement bars may be installed when the cable carrier is made to order.
  - Stay width  $B > 600$  can also be used in certain cases. Contact a Tsubaki representative for further information.
  - The L-shaped fixing element type is used when stay width  $B > 600$ .

## Dimension drawings/steel bracket dimensions

**Moving end bracket**

Bending radius R (mm)	Mounting height H' (mm)
350	950
450	1150
600	1450
750	1750

**Fixed end bracket**

Bending radius R (mm)	Bending angle (°)	
	Moving end side (α)	Fixed end side (β)
350	41	41
450	31	31
600	23	23
750	18	18

Note: Design and install according to the mounting height  $H'$  dimension.

Outside mounting		Inside mounting	
Moving end bracket	Fixed end bracket	Moving end bracket	Fixed end bracket
MO	FO	MI	FI

## Stay widths (TK Series/TKH Series)

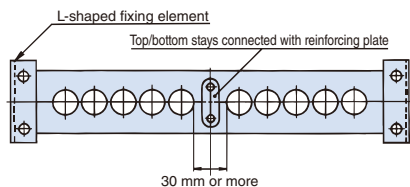

- Notes:
- Stays can also be manufactured in widths ( $B$  dimension) greater than those listed in the stay dimensions table.
  - For supports with  $B > 600$  mm, the stay is installed with L-shaped fixing elements and not tapped holes as a general rule. For split stays, the top and bottom stays are also connected with a reinforcing plate.
  - The  $B$  dimension can also be manufactured at sizes not listed in the table.
  - Select the  $A$  dimension from the standard stays.



### Basic specifications

Maximum travel speed (m/min)	60	
Operating temperature range (°C)	-10 to 150	
Materials	Chain	Steel (Trivalent chromate plating)
	Bracket	Steel (Trivalent chromate plating)
	Stay	Aluminum
Standard length (No. of links)	6	

**Note:** About support rollers  
First consider the cable carrier without support rollers. If conditions/specifications are not satisfied, add the support rollers.

### Load diagram

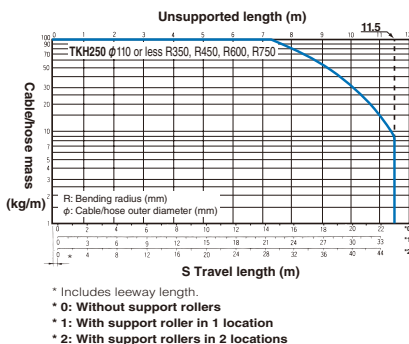

### Calculating no. of links

$$\text{Number of links} = \frac{S}{2} + \pi R + 2K$$

**Note:** When fixed end is at the center of the travel length. Always round up the value after calculating.  
\* The number of links must be an odd number.

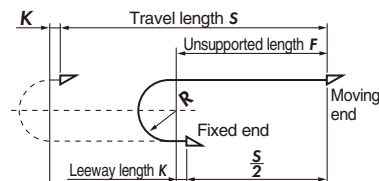

**S:** Travel length (mm)  
**R:** Bending radius (mm)  
**P:** Pitch = 250 mm  
**K:** Leeway length = 270 mm or greater

### Model number

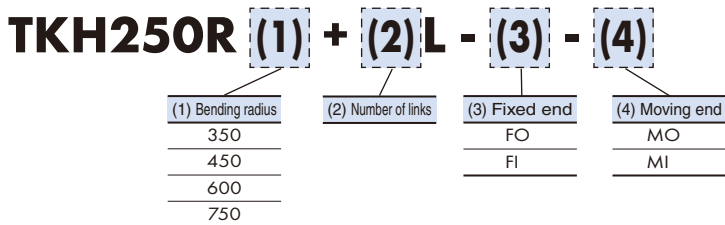

#### Steel bracket (including pin and circlip)

Model number	For cable carrier model number
TKH250-MO	TKH250R ■■
TKH250-MI	
TKH250-FO	
TKH250-FI	

#### Stay (thickness 20 mm)

**Example:**  
**TKH250-SP110-450 B-TK**

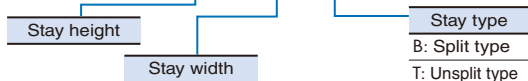

#### Bore dimensions

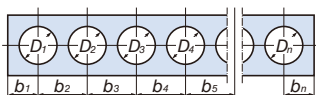

**Example:** Bore diameter (from left) 40/50/50/40  
Distance between stay bores (from left) 45/90/90/80/45

	D <sub>1</sub>	D <sub>2</sub>	D <sub>3</sub>	D <sub>4</sub>	
Bore diameter	40	50	50	40	
Distance between stay bores	b <sub>1</sub>	b <sub>2</sub>	b <sub>3</sub>	b <sub>4</sub>	b <sub>5</sub>
	45	90	90	80	45

**Note:** "From left" means as viewed from the direction of the A-A arrow view in the dimensional drawing.

Model number	Stay height A	Stay width B	For cable carrier model number	
TKH250-SP90-350T-TK	90	350	TKH250R ■■	
TKH250-SP90-350B-TK		400		
TKH250-SP90-400T-TK		450		
TKH250-SP90-400B-TK		500		
TKH250-SP90-450T-TK		550		
TKH250-SP90-450B-TK		600		
TKH250-SP90-500T-TK		110		350
TKH250-SP90-500B-TK				400
TKH250-SP90-550T-TK				450
TKH250-SP90-550B-TK				500
TKH250-SP90-600T-TK	550			
TKH250-SP90-600B-TK	600			
TKH250-SP110-350T-TK	150		350	
TKH250-SP110-350B-TK			400	
TKH250-SP110-400T-TK			450	
TKH250-SP110-400B-TK			500	
TKH250-SP110-450T-TK		550		
TKH250-SP110-450B-TK		600		
TKH250-SP110-500T-TK		TKH250R ■■	350	
TKH250-SP110-500B-TK			400	
TKH250-SP110-550T-TK			450	
TKH250-SP110-550B-TK			500	
TKH250-SP110-600T-TK	550			
TKH250-SP110-600B-TK	600			
TKH250-SP150-350T-TK	TKH250R ■■		350	
TKH250-SP150-350B-TK			400	
TKH250-SP150-400T-TK			450	
TKH250-SP150-400B-TK			500	
TKH250-SP150-450T-TK		550		
TKH250-SP150-450B-TK		600		
TKH250-SP150-500T-TK		TKH250R ■■	350	
TKH250-SP150-500B-TK			400	
TKH250-SP150-550T-TK			450	
TKH250-SP150-550B-TK			500	
TKH250-SP150-600T-TK	550			
TKH250-SP150-600B-TK	600			

# TKS070

## Structure

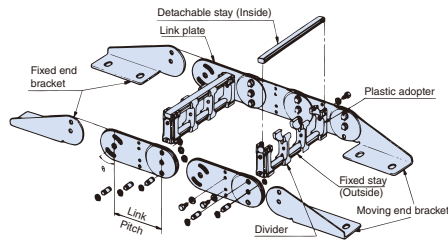

## Cross-section dimensions

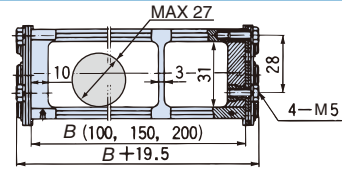

A-A arrow view

Cable/hose maximum outer diameter $d_{MAX}$ (mm)	27		
Frame width B (mm)	100	150	200
Minimum number required	0	1	2
Maximum number installable	5	8	12

## Dimension drawings/steel bracket dimensions

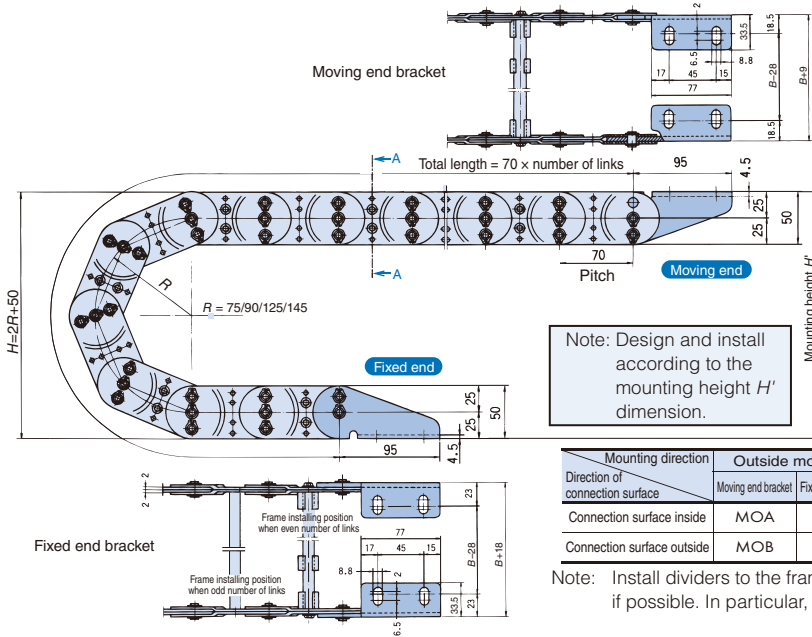

Bending radius R (mm)	Mounting height H' (mm)
75	210
90	240
125	310
145	350

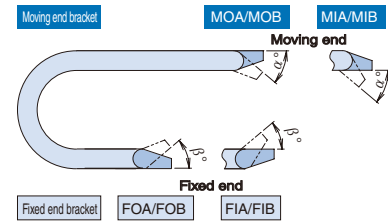

Bending radius R (mm)	Bending angle (°)	
	Moving end side ( $\alpha$ )	Fixed end side ( $\beta$ )
75	0	54
90	0	45
125	0	31
145	0	27

Note: Design and install according to the mounting height H' dimension.

Mounting direction Direction of connection surface	Outside mounting		Inside mounting	
	Moving end bracket	Fixed end bracket	Moving end bracket	Fixed end bracket
Connection surface inside	MOA	FOA	MIA	FIA
Connection surface outside	MOB	FOB	MIB	FIB

Note: Install dividers to the frame and ensure that one cable or hose goes through one opening if possible. In particular, ensure that cables and hoses do not lay on each other.

## Basic specifications

Maximum travel speed (m/min)	60	
Operating temperature range (°C)	-10 to 80	
Materials	Chain	Steel (Trivalent chromate plating)
	Bracket	Steel (Trivalent chromate plating)
	Frame	Aluminum Steel/engineering plastic
Standard length (No. of links)	50	

## Load diagram

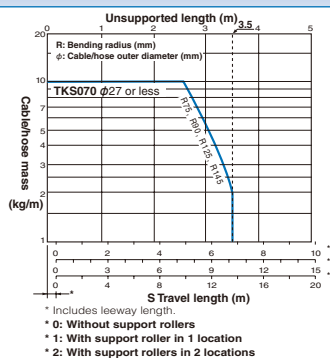

## Calculating no. of links

$$\text{Number of links} = \frac{S}{P} + \frac{\pi R}{P} + 2K$$

Note: When fixed end is at the center of the travel length. Always round up the value after calculating.

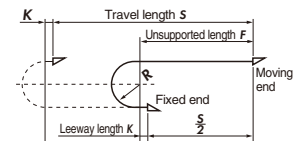

S: Travel length (mm)  
R: Bending radius (mm)  
P: Pitch = 70 mm  
K: Leeway length = 105 mm or greater

## Model number

TKS070SP (1) R (2) + (3) L - (4) - (5)

(1) Frame width	(2) Bending radius	(3) Number of links	(4) Fixed end	(5) Moving end
100	75		FOA	MOA
150	90		FIA	MIA
200	125		FOB	MOB
	145		FIB	MIB

Note: Frames and steel brackets are delivered installed.

### Frame (no dividers)

Model number	Frame width B	For cable carrier model number
TKS070-SP100	100	TKS070SP100R ■■
TKS070-SP150	150	TKS070SP150R ■■
TKS070-SP200	200	TKS070SP200R ■■

### Divider

Model number	For cable carrier model number
TKS070-ST	TKS070SP ■■ R ■■

### Steel bracket (including pin and circlip)

Model number	For cable carrier model number
TKS070-MOA	TKS070SP ■■ R ■■
TKS070-MOB	
TKS070-MIA	
TKS070-MIB	
TKS070-FOA	
TKS070-FOB	
TKS070-FIA	
TKS070-FIB	

# TKS095

## Structure

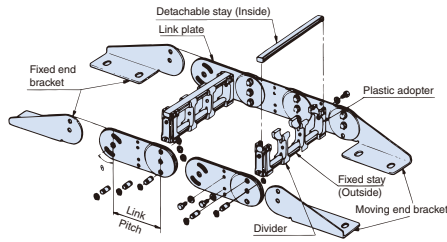

## Cross-section dimensions

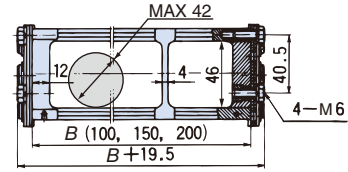

A-A arrow view

Cable/hose maximum outer diameter $d_{MAX}$ (mm)		42		
Frame width B (mm)		100	150	200
Divider	Minimum number required	0	1	2
	Maximum number installable	4	7	11

## Dimension drawings/steel bracket dimensions

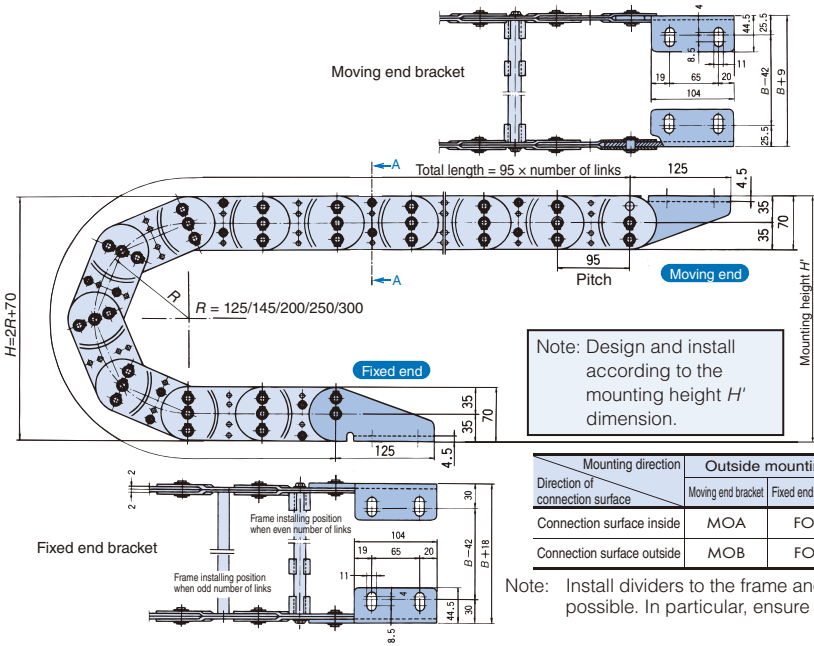

Bending radius R (mm)	Mounting height H' (mm)
125	330
145	370
200	480
250	580
300	680

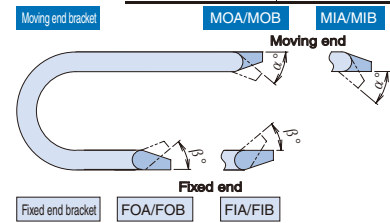

Bending radius R (mm)	Bending angle (°)	
	Moving end side ( $\alpha$ )	Fixed end side ( $\beta$ )
125	0	44
145	0	37
200	0	26
250	0	21
300	0	17

Note: Install dividers to the frame and ensure that one cable or hose goes through one opening if possible. In particular, ensure that cables and hoses do not lay on each other.

## Basic specifications

Maximum travel speed (m/min)	60	
Operating temperature range (°C)	-10 to 80	
Materials	Chain	Steel (Trivalent chromate plating)
	Bracket	Steel (Trivalent chromate plating)
	Frame	Aluminum Steel/engineering plastic
Standard length (No. of links)	25	

## Load diagram

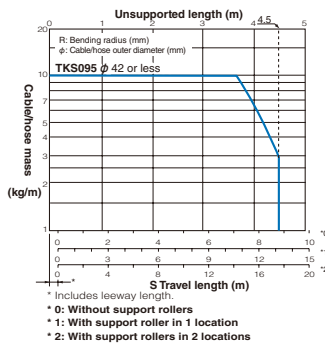

## Calculating no. of links

$$\text{Number of links} = \frac{S}{P} + \frac{\pi R + 2K}{P}$$

Note: When fixed end is at the center of the travel length. Always round up the value after calculating.

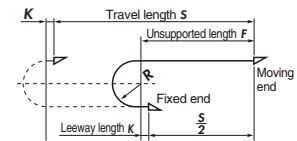

S: Travel length (mm)  
 R: Bending radius (mm)  
 P: Pitch = 95 mm  
 K: Leeway length = 145 mm or greater

## Model number

TKS095SP (1) R (2) + (3) L - (4) - (5)

(1) Frame width	(2) Bending radius	(3) Number of links	(4) Fixed end	(5) Moving end
100	125		FOA	MOA
150	145		FIA	MIA
200	200		FOB	MOB
	250			
	300		FIB	MIB

Note: Frames and steel brackets are delivered installed.

### ■ Frame (no dividers)

Model number	Frame width B	For cable carrier model number
TKS095-SP100	100	TKS095SP100R ■■
TKS095-SP150	150	TKS095SP150R ■■
TKS095-SP200	200	TKS095SP200R ■■

### ■ Divider

Model number	For cable carrier model number
TKS095-ST	TKS095SP ■■R ■■

### ■ Steel bracket (including pin and circlip)

Model number	For cable carrier model number
TKS095-MOA	TKS095SP ■■R ■■
TKS095-MOB	
TKS095-MIA	
TKS095-MIB	
TKS095-FOA	
TKS095-FOB	
TKS095-FIA	
TKS095-FIB	

# TKF055

## Structure

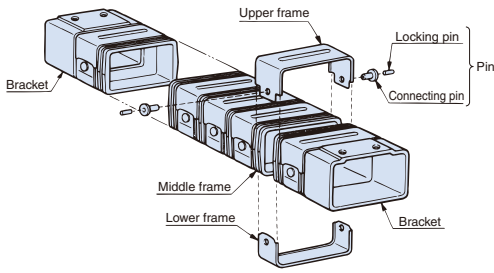

## Cross-section dimensions

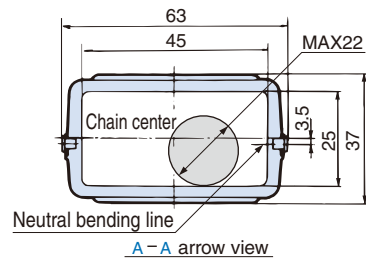

## Dimension drawings/bracket dimensions

### Chain

Dimensions in ( ) are for the B and C type brackets.

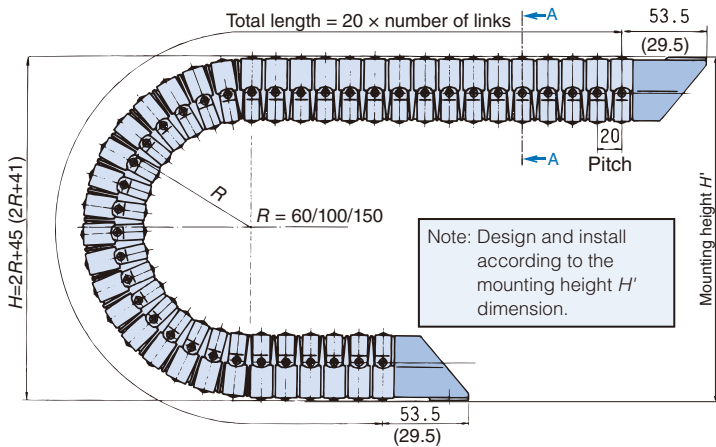

Note: Design and install according to the mounting height  $H'$  dimension.

Bending radius R (mm)	Mounting height $H'$ (mm)	
	A type	B/C type
60	185 to 195	181 to 191
100	265 to 275	261 to 271
150	365 to 375	361 to 371

### Bracket

#### (1) A type

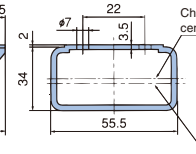
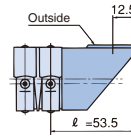

TKF055-KGAO/KGAI  
KGAO: Outside mounting  
KGAI: Inside mounting



#### (2) B type

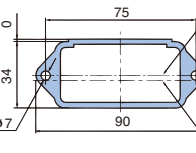
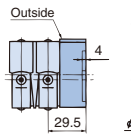

TKF055-KGB



#### (3) C type

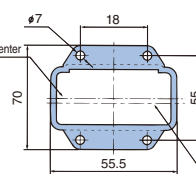
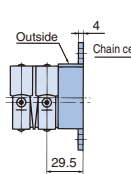

TKF055-KGC

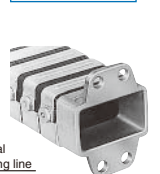

## Basic specifications

Maximum travel speed (m/min)	60	
Operating temperature range (°C)	-10 to 80	
Materials	Chain	Galvanized steel plate (upper/lower frame) Engineering plastic (middle frame)
	Bracket	Aluminum
Standard length (No. of links)	R60 = 90 R100 = 96 R150 = 104	

Note: The TKF series cannot use support rollers.

## Load diagram

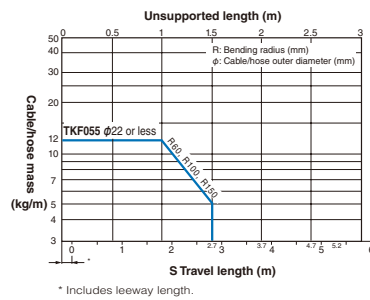

## Calculating no. of links

$$\text{Number of links} = \frac{S}{2} + \pi R + \frac{2K}{P}$$

Note: When fixed end is at the center of the travel length. Always round up the value after calculating.

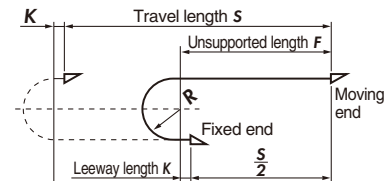

$S$ : Travel length (mm)  
 $R$ : Bending radius (mm)  
 $P$ : Pitch = 20 mm  
 $K$ : Leeway length = 120 mm or greater

## Model number

TKF055R (1) + (2)L - (3) - (4)

(1) Bending radius	(2) Number of links	(3) Fixed end	(4) Moving end
60		KGAO	KGAO
100		KGAI	KGAI
150		KGB	KGB
		KGC	KGC

### Bracket

Model number	For cable carrier model number
TKF055-KGAO	TKF055R ■■
TKF055-KGAI	
TKF055-KGB	
TKF055-KGC	

Notes: 1. Brackets are delivered installed.

2. The mounting holes of the A type bracket are delivered installed on the outside for the KGAO and the inside for the KGAI.

See page 20 for ordering information

See page 150 for product mass

# TKF085

## Structure

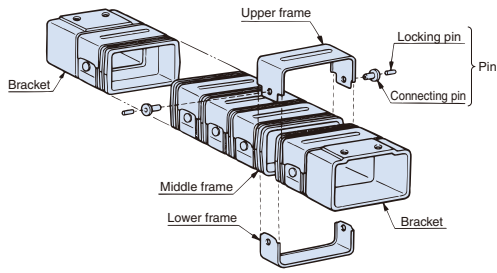

## Cross-section dimensions

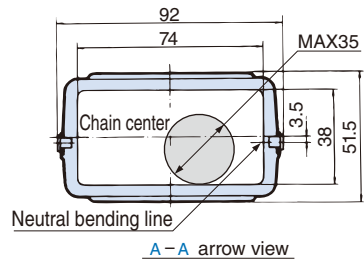

## Dimension drawings/steel bracket dimensions

### Chain

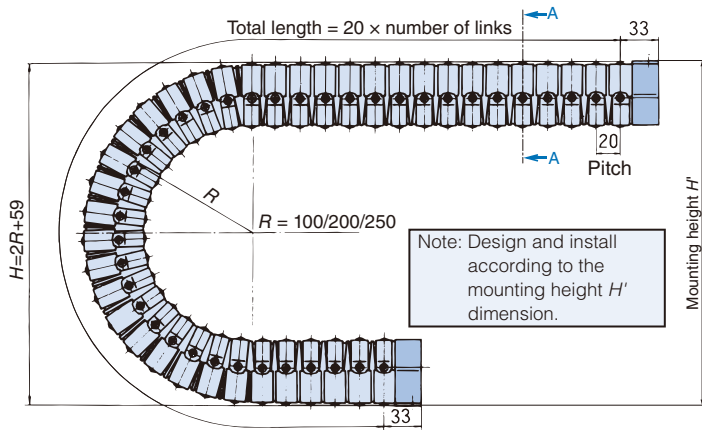

Bending radius R (mm)	Mounting height H' (mm)
100	279 to 289
200	479 to 489
250	579 to 589

### Bracket

#### (1) A type

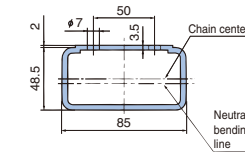
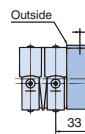

TKF085-KGAO/KGAI  
KGAO: Outside mounting  
KGAI: Inside mounting



#### (2) B type

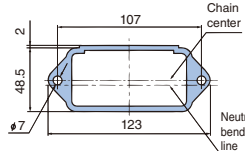
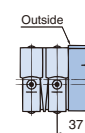

TKF085-KGB



#### (3) C type

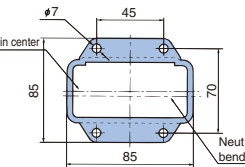
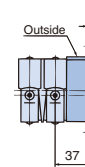

TKF085-KGC

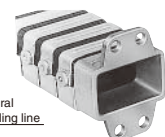

## Basic specifications

Maximum travel speed (m/min)	60	
Operating temperature range (°C)	-10 to 80	
Materials	Chain	Galvanized steel plate (upper/lower frame) Engineering plastic (middle frame)
	Bracket	Aluminum
Standard length (No. of links)	R100 = 121 R200 = 137 R250 = 145	

Note: The TKF series cannot use support rollers.

## Load diagram

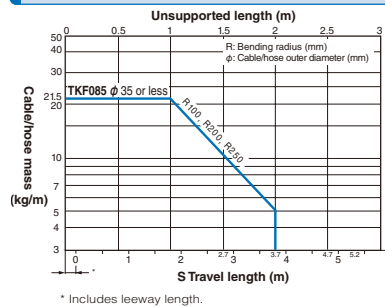

## Calculating no. of links

$$\text{Number of links} = \frac{S}{2} + \frac{\pi R + 2K}{P}$$

Note: When fixed end is at the center of the travel length. Always round up the value after calculating.

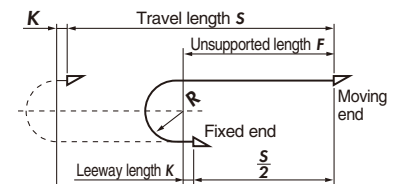

S: Travel length (mm)  
R: Bending radius (mm)  
P: Pitch = 20 mm  
K: Leeway length = 120 mm or greater

## Model number

**TKF085R (1) + (2)L - (3) - (4)**

(1) Bending radius	(2) Number of links	(3) Fixed end	(4) Moving end
100		KGAO	KGAO
200		KGAI	KGAI
250		KGB	KGB
		KGC	KGC

### Steel bracket

Model number	For cable carrier model number
TKF085-KGAO	TKF085R ■■
TKF085-KGAI	
TKF085-KGB	
TKF085-KGC	

Notes: 1. Steel brackets are delivered installed.

2. The mounting holes of the A type bracket are delivered installed on the outside for the KGAO and the inside for the KGAI.

See page 20 for ordering information

See page 150 for product mass

# TKF115

## Structure

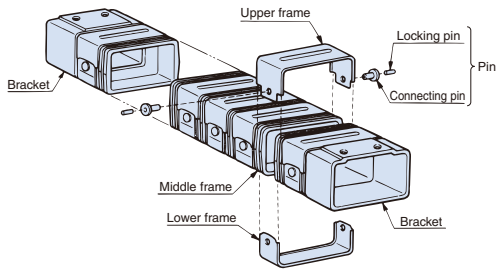

## Cross-section dimensions

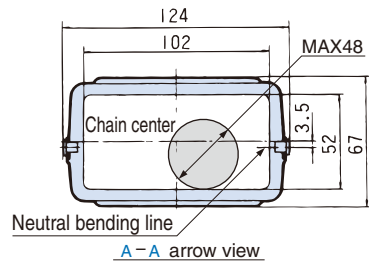

## Dimension drawings/bracket dimensions

### Chain

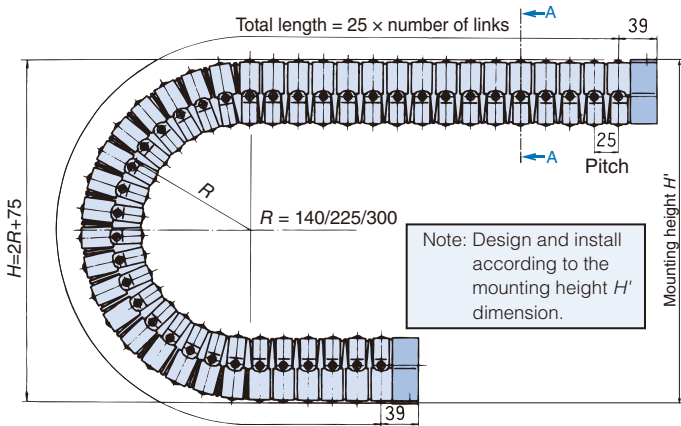

Bending radius R (mm)	Mounting height H' (mm)
140	375 to 385
225	545 to 555
300	695 to 705

### Bracket

#### (1) A type

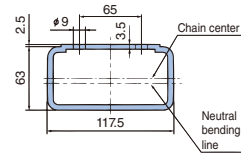
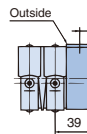

#### (2) B type

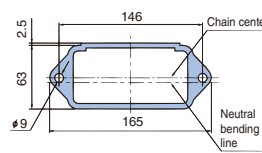
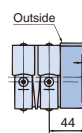

#### (3) C type

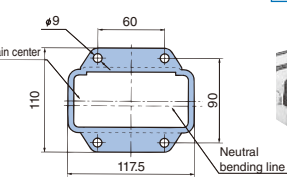
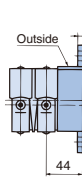

## Basic specifications

Maximum travel speed (m/min)	60	
Operating temperature range (°C)	-10 to 80	
Materials	Chain	Galvanized steel plate (upper/lower frame) Engineering plastic (middle frame)
	Bracket	Aluminum
Standard length (No. of links)	R140 = 123 R225 = 133 R300 = 143	

Note: The TKF series cannot use support rollers.

## Load diagram

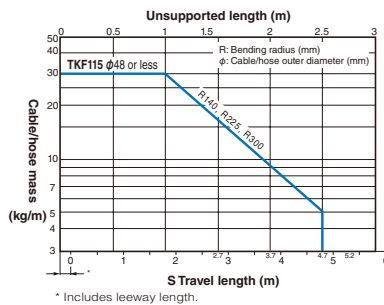

## Calculating no. of links

$$\text{Number of links} = \frac{S}{2} + \pi R + 2K$$

Note: When fixed end is at the center of the travel length. Always round up the value after calculating.

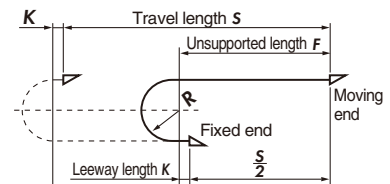

S: Travel length (mm)  
R: Bending radius (mm)  
P: Pitch = 25 mm  
K: Leeway length = 140 mm or greater

## Model number

**TKF115R (1) + (2)L - (3) - (4)**

(1) Bending radius	(2) Number of links	(3) Fixed end	(4) Moving end
140		KGAO	KGAO
225		KGAI	KGAI
300		KGB	KGB
		KGC	KGC

### Bracket

Model number	For cable carrier model number
TKF115-KGAO	TKF115R ■■
TKF115-KGAI	
TKF115-KGB	
TKF115-KGC	

Notes: 1. Brackets are delivered installed.  
2. The mounting holes of the A type bracket are delivered installed on the outside for the KGAO and the inside for the KGAI.

See page 20 for ordering information

See page 150 for product mass

# TKF175

## Structure

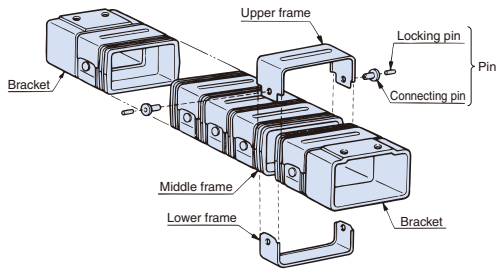

## Cross-section dimensions

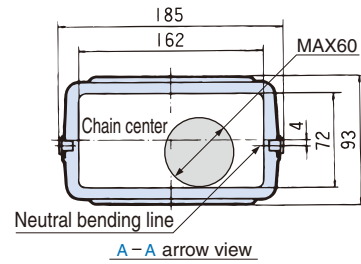

## Dimension drawings/bracket dimensions

### Chain

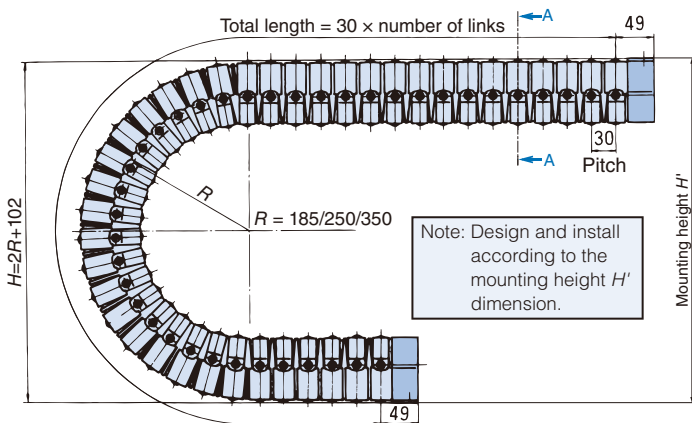

Bending radius R (mm)	Mounting height H' (mm)
185	492 to 502
250	622 to 632
350	822 to 832

### Bracket

#### (1) A type

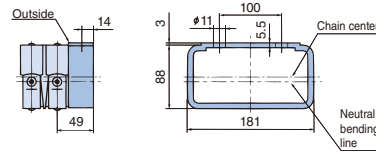

TKF175-KGAO/KGAI  
KGAO: Outside mounting  
KGAI: Inside mounting



#### (2) B type

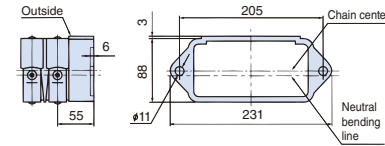

TKF175-KGB



#### (3) C type

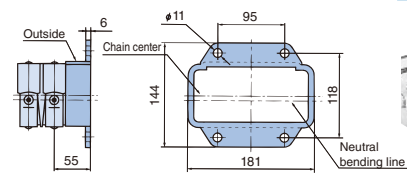

TKF175-KGC



## Basic specifications

Maximum travel speed (m/min)	60	
Operating temperature range (°C)	-10 to 80	
Materials	Chain	Galvanized steel plate (upper/lower frame) Engineering plastic (middle frame)
	Bracket	Aluminum
Standard length (No. of links)	R185 = 117 R250 = 124 R350 = 135	

Note: The TKF series cannot use support rollers.

## Load diagram

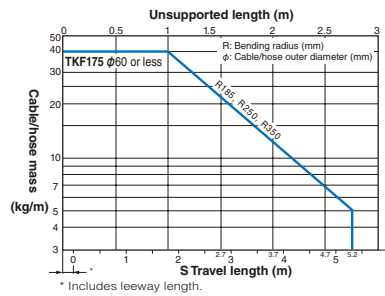

## Calculating no. of links

$$\text{Number of links} = \frac{S}{P} + \frac{\pi R}{P} + 2K$$

Note: When fixed end is at the center of the travel length. Always round up the value after calculating.

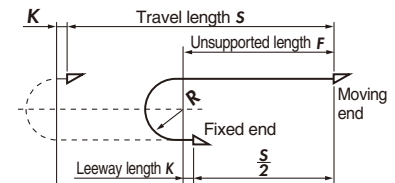

S: Travel length (mm)  
R: Bending radius (mm)  
P: Pitch = 30 mm  
K: Leeway length = 150 mm or greater

## Model number

**TKF175R (1) + (2)L - (3) - (4)**

(1) Bending radius	(2) Number of links	(3) Fixed end	(4) Moving end
185		KGAO	KGAO
250		KGAI	KGAI
350		KGB	KGB
		KGC	KGC

### Bracket

Model number	For cable carrier model number
TKF175-KGAO	TKF175R ■■
TKF175-KGAI	
TKF175-KGB	
TKF175-KGC	

Notes: 1. Brackets are delivered installed.

2. The mounting holes of the A type bracket are delivered installed on the outside for the KGAO and the inside for the KGAI.

See page 20 for ordering information

See page 150 for product mass

# TKV130

Can be used for high speed/high frequency.

## Structure

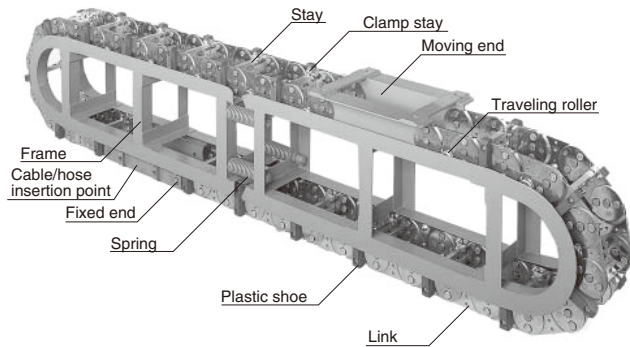

## Stay dimensions

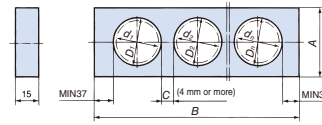

Cable/hose maximum outer diameter $d$ (mm)	Stay height $A$ (mm)
$\phi 46$	65
$\phi 55$	75
$\phi 60$	90

Bending radius $R$ (mm)	Stay width $B$ (mm)					
	150	200	250	300	350	400
200	○	○	○	○	○	○
250	-	○	○	○	○	○
300	-	-	○	○	○	○
400	-	-	-	○	○	○

Note: The  $B$  dimension can be also manufactured at 400 and greater. Consult a Tsubaki representative for further information. (The stay width and height are manufactured at the ordered dimensions.)

## Dimension drawings

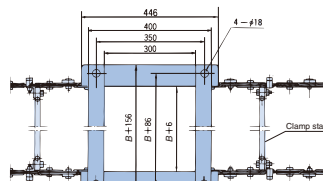
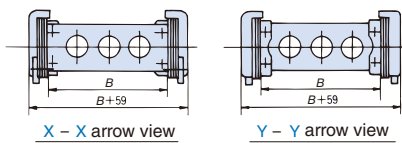
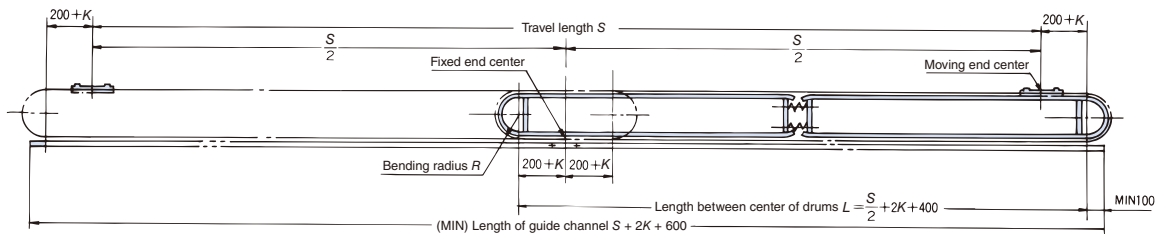

Link pitch: 130 mm  
 Maximum travel length: 30 m  
 Maximum outer diameter of cable and hose: 60 mm  
 Maximum cable/hose mass: 50 kg/m

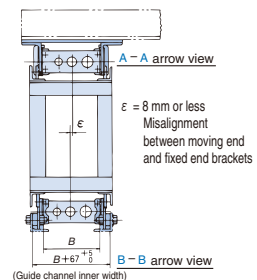
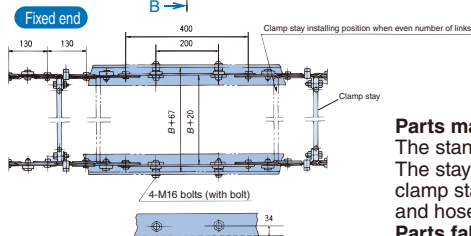
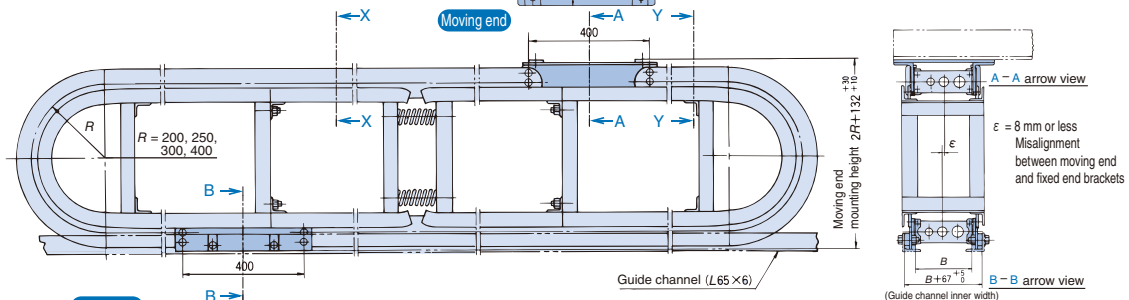

**Parts manufactured by Tsubaki: Frames, links, stays (connecting plates)**  
 The standard coating color is Munsell 2.5B6/2.  
 The stay on the moving end and fixed end both fasten the cables and hoses as clamp stays. Notify the Tsubaki representative of the actual outer diameter of cables and hoses.  
**Parts fabricated by the customer: Guide channels, connecting element for moving end bracket, terminal box**

## Basic specifications

Maximum travel speed (m/min)	150	
Operating temperature range (°C)	-10 to 80	
Materials	Chain	Steel
	Stay	Aluminum

## Ordering information

Notes: 1. Discussions with a Tsubaki representative are necessary to select and order to the TKV Series. Contact a Tsubaki representative for further information.  
 2. In the TKV Series, a lightweight type (TKV095) is also available in addition to the TKV130.



# TKI Series

Suitable for high frequency/long travel length application.

## Structure

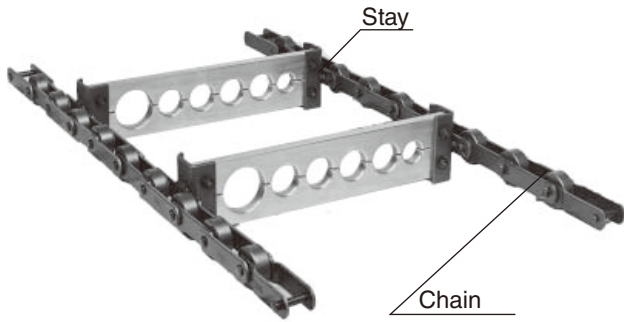

## Stay dimensions

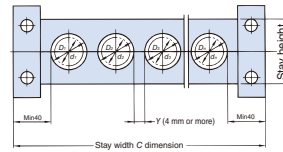

Relationship between standard stay height and cable/hose outer diameter

Stay height (mm)	Stay maximum bore diameter (mm)	Cable/hose maximum outer diameter (mm)
65	φ50	φ46
75	φ60	φ55
90	φ66	φ60
110	φ88	φ80

Relationship between standard stay width (C) and bending radius (R)

Bending radius R (mm)	Stay height (mm)	Standard stay width C (mm)
175	65 to 110	(Min 100) in increments of 50 mm to (Max 500)
200		(Min 100) in increments of 50 mm to (Max 600)
250		(Min 150) in increments of 50 mm to (Max 700)
300		(Min 150) in increments of 50 mm to (Max 900)
350		(Min 200) in increments of 50 mm to (Max 1,000)
400		(Min 200) in increments of 50 mm to (Max 1,200)
500	(Min 250) in increments of 50 mm to (Max 1,500)	

## Dimension drawings/bracket dimensions

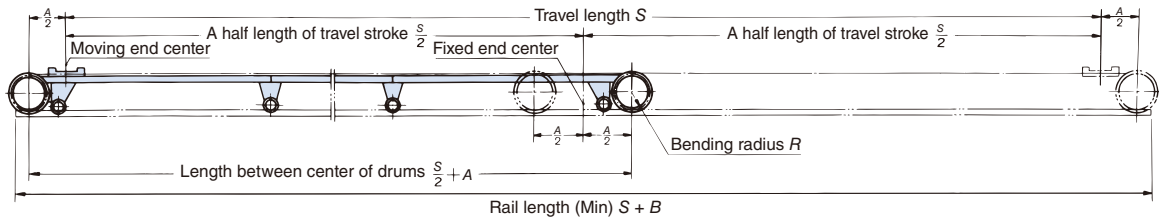

Maximum travel length: 100 m, maximum outer diameter of cable and hose: φ 80 mm, maximum cable/hose mass: 100 kg/m

The standard coating color is Munsell 2.5B6/2.

The stay on the moving end and fixed end both fasten the cables and hoses as clamp stays.

Notify the Tsubaki representative of the actual outer diameter of cables and hoses.

Parts fabricated by the customer: (1) Rails, (2) Chain support channel, (3) Connecting element for moving end bracket, (4) Terminal box

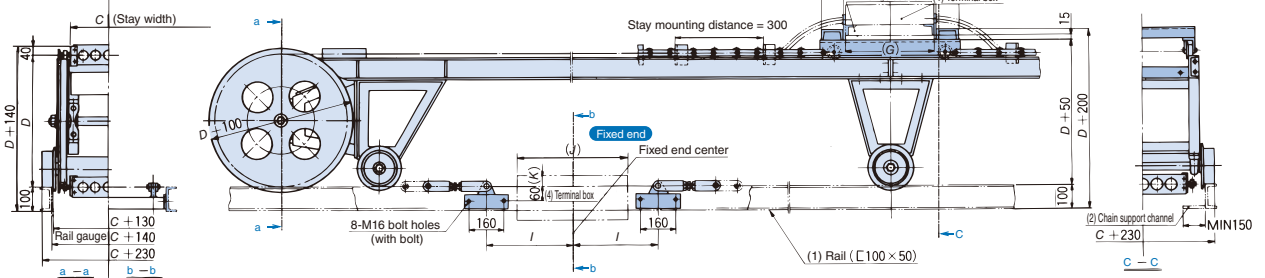

## Dimensions

Bending radius R (mm)	Drum diameter D (mm)	A (mm)	B (mm)	E (mm)	F (mm)	(G) (mm)	I (mm)	(J) (mm)	(K) (mm)
175	350	1800	2000	620	420	max 410	390	max 500	max 40
200	400								
250	500								
300	600								

Bending radius R (mm)	Drum diameter D (mm)	A (mm)	B (mm)	E (mm)	F (mm)	(G) (mm)	I (mm)	(J) (mm)	(K) (mm)
350	700	1800	2000	620	420	MAX 410	390	MAX 500	MAX 40
400	800	2000	2500	820	620	MAX 610	440	MAX 600	MAX 60
500	800								

## Basic specifications

Maximum travel speed (m/min)	120	
Operating temperature range (°C)	-10 to 150	
Materials	Chain	Steel
	Stay	Aluminum

## Ordering information

Note: Discussions with a Tsubaki representative are necessary to select and order to the TKI Series. Contact a Tsubaki representative for further information.



# Cable Carrier TOTALTRAX

## TOTALTRAX

TOTALTRAX ..... 115

# TOTALTRAX

Cables and hoses with attached end connectors are delivered installed in the cable carrier as a set. Installation on machines or equipment following delivery is quick and simple.

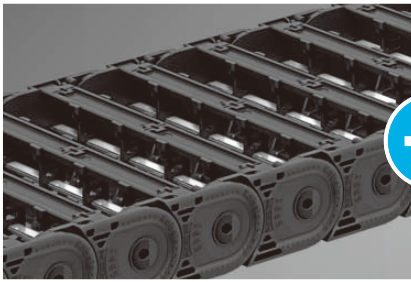

**Cable carrier**



**Cable**



**Connector**



## TOTALTRAX

Cable carrier + Cable/hose ready-to-assembled delivery service

### Benefits of TOTALTRAX

Tsubaki has been supplying cable carrier products to customers worldwide for over 50 years. As the next step, we utilizing our technical prowess cultivated over the years to offer solutions to customers for systems that combine cable carriers and cables/hoses. Tsubaki can provide complete systems with cable carriers, cables, hoses, connectors, guide channels, etc. TOTALTRAX can contribute greatly to solving your problems.

### Ordering process

- |   |   |  |
|---|---|--|
| <p><b>1. Select the cable carrier</b></p> <p>Review the operating environment, operating conditions, and installation method.</p> <p style="text-align: center;">↓</p> <p><b>Decide on the cable carrier</b></p> <ul style="list-style-type: none"> <li>• Open type or closed type</li> <li>• Plastic or steel</li> </ul> | <p><b>2. Select cables and connectors</b></p> <p>Nominal cross-sectional area, number of cores, connector shape, and layout</p> <p style="text-align: center;">↓</p> <p><b>You can select your own cables, hoses, and connectors.</b></p> | <p><b>3. Decide on the TOTALTRAX types</b></p> <p style="text-align: center;">Complete selecting</p> <p style="text-align: center;">↓</p> <p><b>Provide quotation and quotation drawings and calculate price/lead time</b></p> |
|---|---|--|

### Advantages of unifying suppliers

Order at one company + one-shot order + one-shot delivery + guaranteed quality  
 = **Ready-to-assembled delivery service "TOTALTRAX"**

# Cable Carrier Accessories

## Guide Channels for Gliding Arrangement



Guide Channels for Gliding Arrangement ..... 117

## Support Rollers



Support Rollers ..... 119



# Guide Channels for Gliding Arrangement

(Applicable models: TKP45H25, TKP58H39, TKP62H34, TKC34H25, TKC47H36)

## Structure

This part is composed of two types of guide channels: the H2M guide channel (front side) and U2M guide channel (back side).

This part can be used alone, however, there are two fastening bases (SB kit and JB kit) that can be used to easily install guide channels to the mounting surface quickly and precisely.

Guide channel clamps (RCL06) can be used to easily align guide channel joints at connections. Guide channels and guide channel clamps can also be used alone.

Notes: 1. Guide channels are made of aluminum, anodized, and painted silver.  
2. Fasten guide channels every meter.

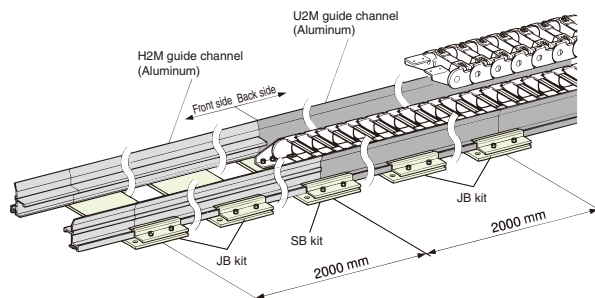

### JB kit

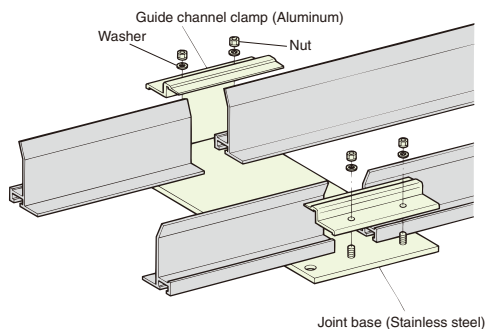

Notes: ★ 1. Cable carriers and fixed end brackets are sold separately.  
★ 2. Guide channels are not included in the JB kit and SB kit.

3. The setting base has a structure to which the fixed end bracket of the cable carrier can be installed. The other dimensions are the same as the joint base.
4. The guide channels will wear down quickly when the travel speed is high. Contact a Tsubaki representative for further information.
5. The guide channels will also wear down quickly in environments where dust, debris, or other matter is allowed to accumulate.
6. Do not install and use outdoors.
7. The guide channels will shrink and expand when used in locations with large temperature differences. Allow sufficient leeway at the guide channel joints for shrinking and expansion.

### SB kit

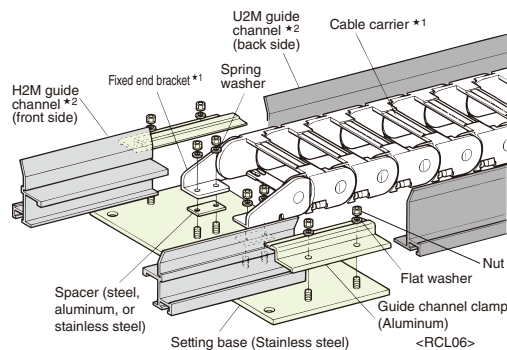

## Dimension drawings

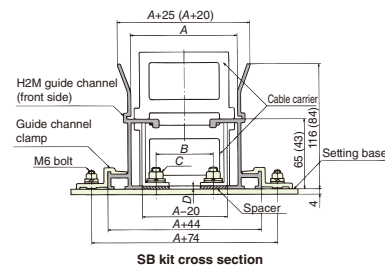
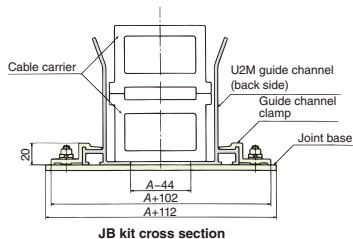
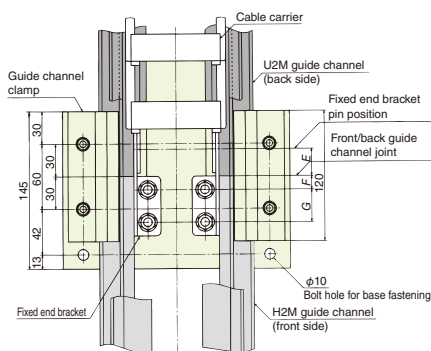

Figures in ( ) are dimensions for the TKP45H25 and TKC34H25.

Cable carrier	A (mm)	B (mm)	C (mm)	D (mm)	E (mm)	F (mm)	G (mm)	Guide channel model number		Fastening base model number	
								H guide channel (H2M)	U guide channel (U2M)	JB kit	SB kit
TKP45H25-30W38	62	23	M6	8	17	8	24	TKP45H25-H2M	TKP45H25-U2M	TKP45H25W38-JB	TKP45H25W38-SB
TKP45H25-30W58	84	44	M6	8	17	8	24			TKP45H25W58-JB	TKP45H25W58-SB
TKP45H25-30W78	104	64	M6	8	17	8	24			TKP45H25W78-JB	TKP45H25W78-SB
TKP45H25-30W103	129	89	M6	8	17	8	24			TKP45H25W103-JB	TKP45H25W103-SB
TKP58H39-30W50	77	37	M6	15	21	10.5	24	TKP58H39-H2M	TKP58H39-U2M	TKP58H39W50-JB	TKP58H39W50-SB
TKP58H39-30W75	102	62	M6	15	21	10.5	24			TKP58H39W75-JB	TKP58H39W75-SB
TKP58H39-30W100	127	87	M6	15	21	10.5	24			TKP58H39W100-JB	TKP58H39W100-SB
TKP58H39-30W125	152	112	M6	15	21	10.5	24			TKP58H39W125-JB	TKP58H39W125-SB
TKP58H39-30W50 with gliding shoe	81	37	M6	10	21	10.5	24	TKP58H39-H2M	TKP58H39-U2M	TKP58H39W50GS-JB	TKP58H39W50GS-SB
TKP58H39-30W75 with gliding shoe	106	62	M6	10	21	10.5	24			TKP58H39W75GS-JB	TKP58H39W75GS-SB
TKP58H39-30W100 with gliding shoe	131	87	M6	10	21	10.5	24			TKP58H39W100GS-JB	TKP58H39W100GS-SB
TKP58H39-30W125 with gliding shoe	156	112	M6	10	21	10.5	24			TKP58H39W125GS-JB	TKP58H39W125GS-SB
TKP62H34W150	178	123	M8	12	25	12.5	30	TKP62H34-H2M	TKP62H34-U2M	TKP62H34W150-JB	TKP62H34W150-SB
TKP62H34W200	228	173	M8	12	25	12.5	30			TKP62H34W200-JB	TKP62H34W200-SB
TKC34H25W50	80	30	M8	3	20	8	24	TKC34H25-H2M	TKC34H25-U2M	TKC34H25W50-JB	TKC34H25W50-SB
TKC34H25W90	120	70	M8	3	20	8	24			TKC34H25W90-JB	TKC34H25W90-SB
TKC34H25W130	160	110	M8	3	20	8	24			TKC34H25W130-JB	TKC34H25W130-SB
TKC47H36W80	116	63	M8	12	25	12.5	30			TKC47H36W80-JB	TKC47H36W80-SB
TKC47H36W160	196	143	M8	12	25	12.5	30	TKC47H36W160-JB	TKC47H36W160-SB		

Note: The TKP45H25 and TKC34H25 guide channels are common parts. The TKP58H39, TKP62H34, and TKC47H36 guide channels are common parts.

## Operating range

Operating range of aluminum guide channels

- (1) Maximum travel speed: 60 m/min or less (as a countermeasure for wear)
- (2) Not for outdoor use.
- (3) Clearance is required between guide channels in high-temperature environments because the entire length will change due to the temperature.

Linear coefficient of expansion:  $2.4 \times 10^{-5}$  (20°C to 100°C)

Amount of change = Entire length (mm) × Temperature difference (°C) × 0.000024

## Calculating the guide channel length

When fixed end is at the center of the length

$$H \text{ guide channel length} = \frac{S}{2} - E$$

E: Refer to installation dimensions table, R: Cable carrier bending radius

$$U \text{ guide channel length} = \frac{S}{2} + K + R + E + 100$$

S: Travel length, 100: Guide channel leeway length, K: Leeway length

Guide channels have a standard length of 2000 mm. Order rails in increments of 2000 mm and give the calculated result some leeway.

## Model number

Example: Using the TKP45H25-30W38R50 with a travel length of 10 m

	Model number		
H2M guide channel	TKP45H25- <b>H2M</b>	3	[S (set)]
U2M guide channel	TKP45H25- <b>U2M</b>	3	[S (set)]
SB kit	TKP45H25W38- <b>SB</b>	1	[S (set)]
JB kit	TKP45H25W38- <b>JB</b>	12	[S (set)]

Notes: 1. The H2M guide channel and U2M guide channel make up one set. (\* Standard length: 2000 mm/guide channel)

2. Configuration: SB kit: Setting base (SB), guide channel clamps, spacers, nuts, and washers

JB kit: Joint base (JB), guide channel clamps, nuts, and washers

## Model number

### ■ Guide channels for gliding arrangement

Model number	For cable carrier model number
TKP45H25-H2M	TKP45H25-30W■■■R■■
TKP45H25-U2M	
TKP58H39-H2M	TKP58H39-30W■■■R■■
TKP58H39-U2M	
TKP62H34-H2M	TKP62H34-30W■■■R■■
TKP62H34-U2M	
TKC34H25-H2M	TKC34H25W■■■R■■
TKC34H25-U2M	
TKC47H36-H2M	TKC47H36W■■■R■■
TKC47H36-U2M	

### ■ JB kit (joint base)

Model number	For cable carrier model number
TKP45H25W38-JB	TKP45H25-30W38R■■
TKP45H25W58-JB	TKP45H25-30W58R■■
TKP45H25W78-JB	TKP45H25-30W78R■■
TKP45H25W103-JB	TKP45H25-30W103R■■
TKP58H39W50-JB	TKP58H39-30W50R■■
TKP58H39W75-JB	TKP58H39-30W75R■■
TKP58H39W100-JB	TKP58H39-30W100R■■
TKP58H39W125-JB	TKP58H39-30W125R■■
TKP58H39W50GS-JB	TKP58H39-30W50R■■ with gliding shoe (R125, R150, R200)
TKP58H39W75GS-JB	TKP58H39-30W75R■■ with gliding shoe (R125, R150, R200)
TKP58H39W100GS-JB	TKP58H39-30W100R■■ with gliding shoe (R125, R150, R200)
TKP58H39W125GS-JB	TKP58H39-30W125R■■ with gliding shoe (R125, R150, R200)
TKP62H34W150-JB	TKP62H34W150R■■
TKP62H34W200-JB	TKP62H34W200R■■
TKC34H25W50-JB	TKC34H25W50R■■
TKC34H25W90-JB	TKC34H25W90R■■
TKC34H25W130-JB	TKC34H25W130R■■
TKC47H36W80-JB	TKC47H36W80R■■
TKC47H36W160-JB	TKC47H36W160R■■

### ■ SB kit (setting base)

Model number	For cable carrier model number
TKP45H25W38-SB	TKP45H25-30W38R■■
TKP45H25W58-SB	TKP45H25-30W58R■■
TKP45H25W78-SB	TKP45H25-30W78R■■
TKP45H25W103-SB	TKP45H25-30W103R■■
TKP58H39W50-SB	TKP58H39-30W50R■■
TKP58H39W75-SB	TKP58H39-30W75R■■
TKP58H39W100-SB	TKP58H39-30W100R■■
TKP58H39W125-SB	TKP58H39-30W125R■■
TKP58H39W50GS-SB	TKP58H39-30W50R■■ with gliding shoe (R125, R150, R200)
TKP58H39W75GS-SB	TKP58H39-30W75R■■ with gliding shoe (R125, R150, R200)
TKP58H39W100GS-SB	TKP58H39-30W100R■■ with gliding shoe (R125, R150, R200)
TKP58H39W125GS-SB	TKP58H39-30W125R■■ with gliding shoe (R125, R150, R200)
TKP62H34W150-SB	TKP62H34W150R■■
TKP62H34W200-SB	TKP62H34W200R■■
TKC34H25W50-SB	TKC34H25W50R■■
TKC34H25W90-SB	TKC34H25W90R■■
TKC34H25W130-SB	TKC34H25W130R■■
TKC47H36W80-SB	TKC47H36W80R■■
TKC47H36W160-SB	TKC47H36W160R■■

### ■ Guide channel clamps

Model number	Applicable bases
RCL06	Applicable to all SB and JB bases



# Support Rollers (Applicable Models: TK/TKH/TKS Series)

Support roller designs for the TKC Series are in stock. Contact a Tsubaki representative for further information. Support plates are also available for the TKC Series.

## Dimension drawings

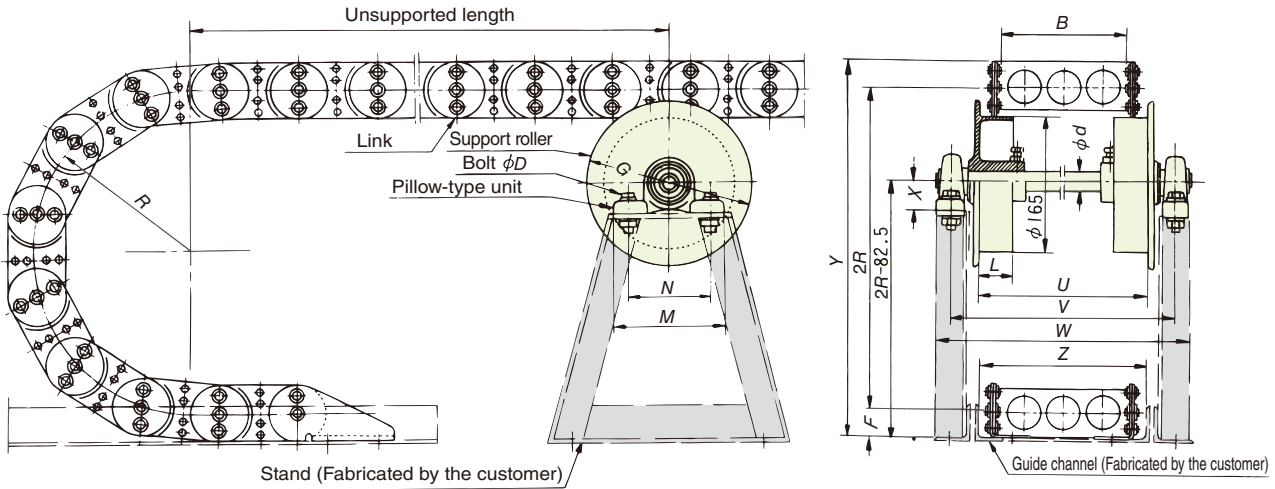

Model	Min. stay dimension B (mm)	Min. bending radius R (mm)	d (mm)	G (mm)	M (mm)	N (mm)	U (mm)	V (mm)	W (mm)
TK070, TKS070	100	125	25	205	140	105	B + 45	B + 115	B + 153
TK095, TKS095		200							
TK130		285							
TK180	125	250		365	184	137	B + 55	B + 125	B + 163
TKH250	350	350	40				B + 75	B + 176	B + 230

Model	L (mm)	F (mm)	X (mm)	Y (mm)	Z (mm)	Bolt diameter D (mm)
TK070, TKS070	45	25	36.5	2R + 50	B + 40	M12
TK095, TKS095		35		2R + 70		
TK130		48		2R + 96		
TK180		70		2R + 140		
TKH250	55	110	49.2	2R + 220	B + 70	M16

- Notes: 1. When ordering support rollers, inform a Tsubaki representative of the cable carrier model, bending radius, and stay width (frame width).  
 2. Designs for support rollers for TK070 and TKS070 R75 and R90 are also in stock.  
 3. Stands differ depending on the installation conditions. Inform a Tsubaki representative of the mounting dimensions so that stands can be manufactured.  
 4. Install so the flange inner width (U dimension) of the support roller is parallel to the reciprocating direction of the moving end.  
 5. All support rollers are made to order.  
 6. Clearly specify if the stay has an L-shaped fixing element.  
 7. The stainless steel type is a special product. Contact a Tsubaki representative for further information.  
 8. If the moving end bracket is installed on the inside, ensure that it does not make contact with the support roller.

## Model number

### ■ For the TK Series

Model number	For cable carrier model number
TK070-SPR	TK070R■■
TK095-SPR	TK095R■■
TK130-SPR	TK130R■■
TK180-SPR	TK180R■■

### ■ For the TKS Series

Model number	For cable carrier model number
TKS070-SPR	TKS070R■■■
TKS095-SPR	TKS095R■■■

### ■ For the TKH Series

Model number	For cable carrier model number
TKH250-SPR	TKH250R■■■



# Cable Carriers Technical Handbook

## Applications

Applications ..... 121

## Examples of Cable Carrier Installations

Examples of Cable Carrier Installations ..... 123

## Cable Carrier Special Types

Gliding Arrangement ..... 127

Circular Travel Arrangements ..... 133

Other Special Types ..... 134

## Cable Carrier Internal Cross-Section Dimensions

Cable Carrier Internal Cross-Section Dimensions ..... 136

## Table of Product Masses

Table of Product Masses ..... 143

## Cable Carrier Selection

Cable Carrier Selection ..... 151

## Cable Carrier Handling

Cable Carrier Handling ..... 157

## Cable Carrier Connecting/Assembly

Cable Carrier Connecting/Assembly ..... 160

## Cable Carrier Usage Limitations

Cable Carrier Usage Limitations ..... 163

---

Cable Carrier Inquiries Sheet ..... 164

Safety Precautions/Warranty ..... 166

# Applications

## LCD/semiconductors/inspection machines

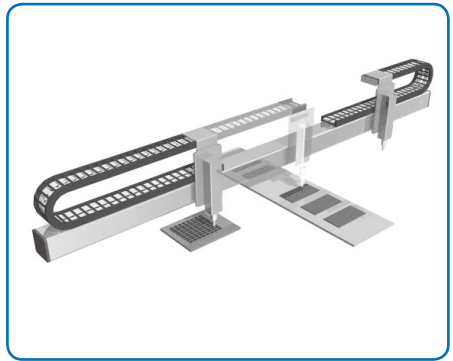
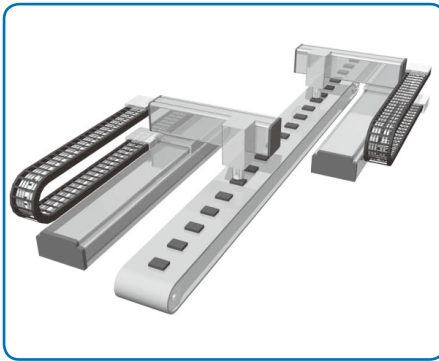
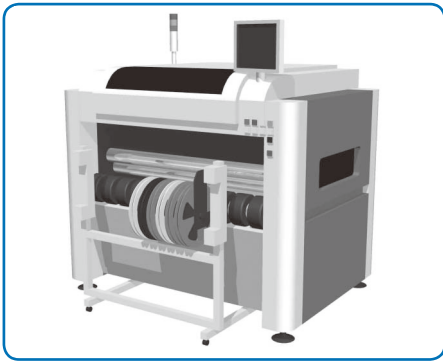

## Machine tools

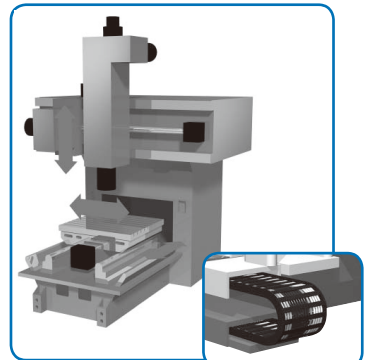
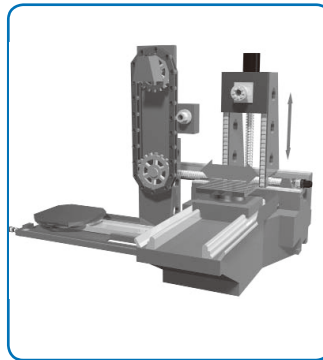
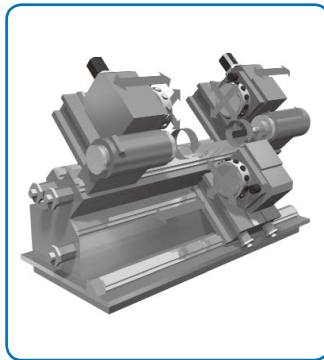
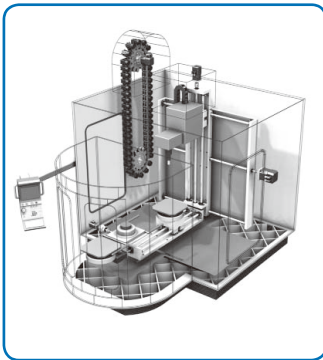

## Injection molding machines

## ATMs

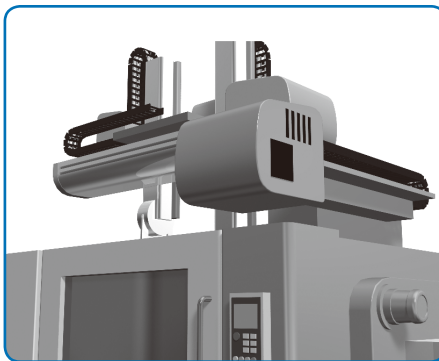
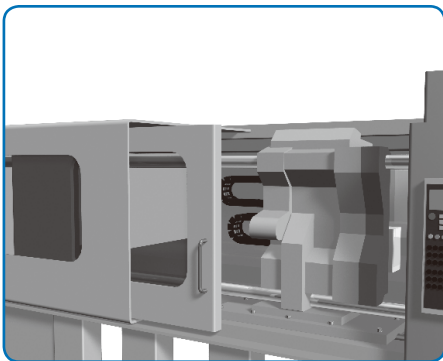

## Medical equipment

## Claw crane arcade games

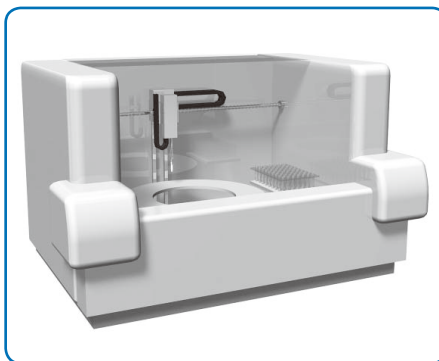
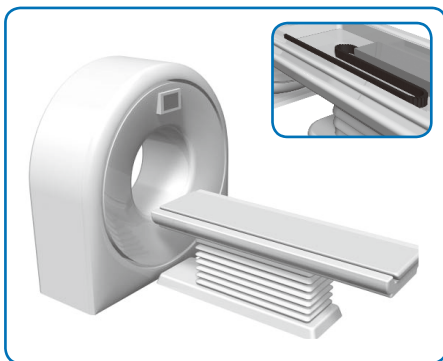

Automobile manufacturing lines

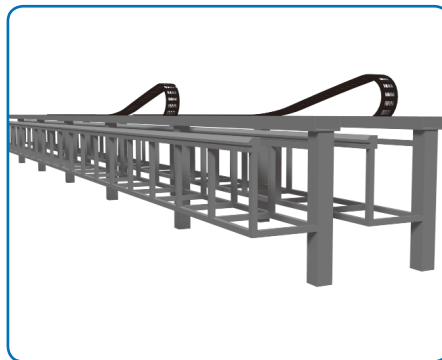
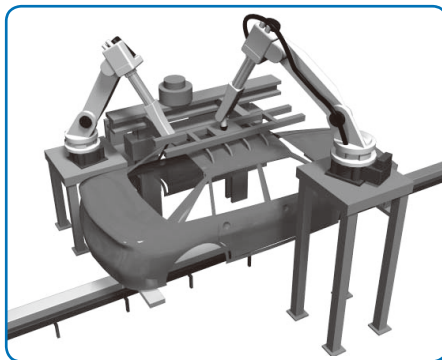
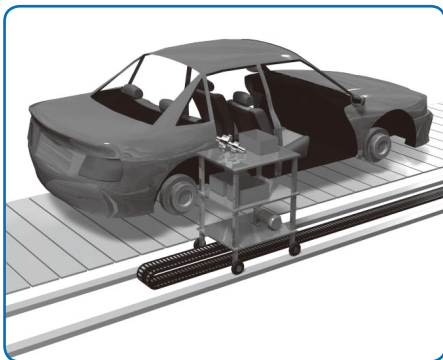

Iron and steel equipment

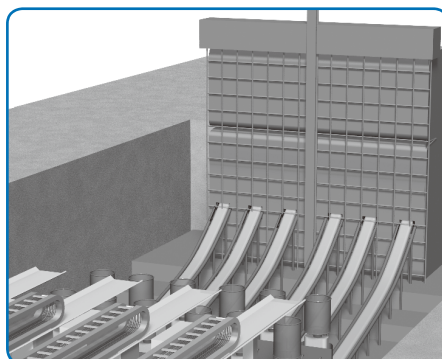
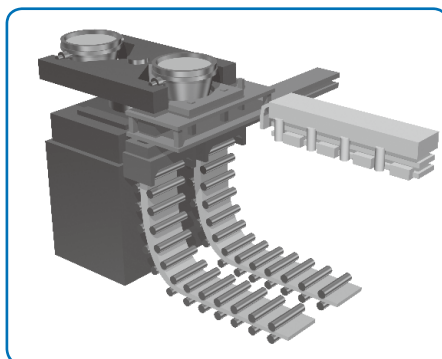
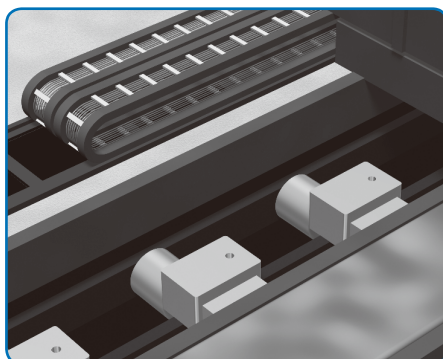

Seaport cranes

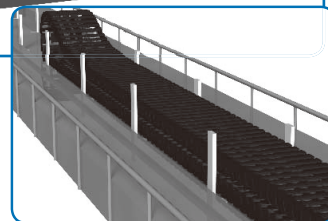
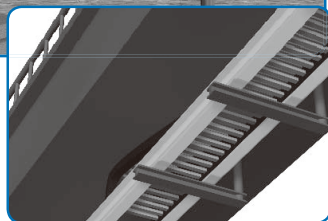
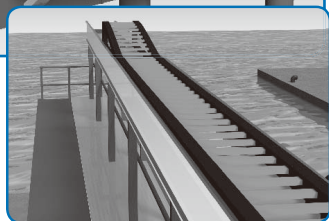
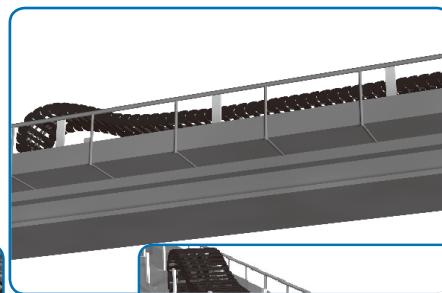
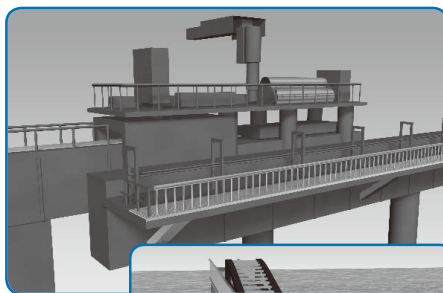

Power sliding doors

Flood-defense gates

Passenger boarding bridges

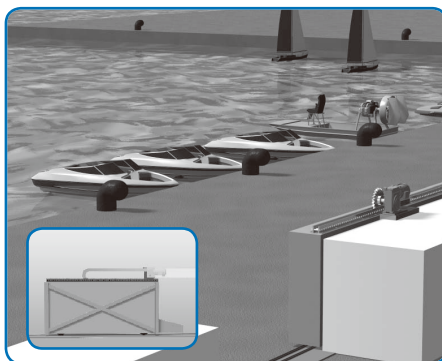
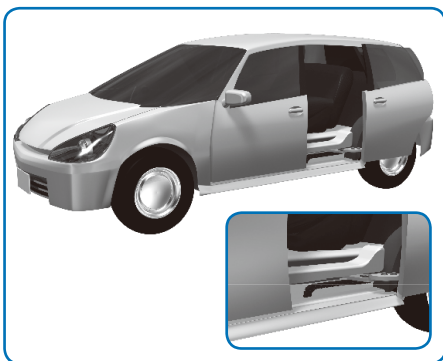

# Examples of Cable Carrier Installations

## 1. Standard arrangement

Applicable to all models

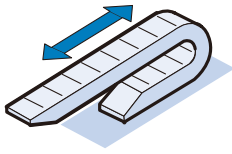

S: Travel length  
K: Leeway length  
F: Unsupported length  
R: Bending radius

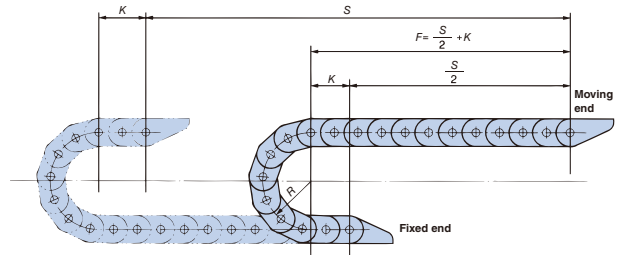

## 2. Support roller arrangement

Applicable to TK Series/TKH Series/TKS Series/TKP Series/TKR Series/TKC Series

Note: Not applicable to the TKF Series.

(Travel speed 150 m/min or less)

◆ For a support roller in one location ( $S_1$ : travel length): The allowable travel length is 1.5-times the travel length when there is no support roller (except the TKR Series\*).

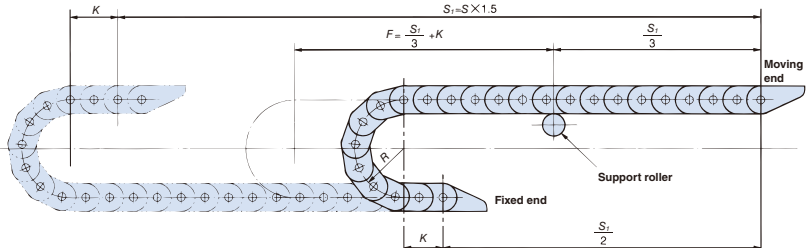
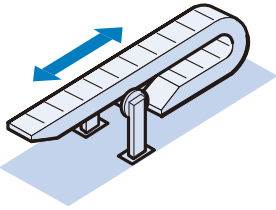

◆ For support rollers in two locations ( $S_2$ : travel length): The allowable travel length is 2-times the travel length when there is no support roller (except the TKR Series\*).

\* The installation distance between support rollers (L) for the TKR Series is as follows:

- TKR15H22: L = 0.35 m or less
- TKR20H28: L = 0.7 m or less
- TKR26H40: L = 0.7 m or less
- TKR28H52: L = 0.9 m or less
- TKR37H28: L = 0.7 m or less

Note: Three or more support rollers may be required depending on the travel length.

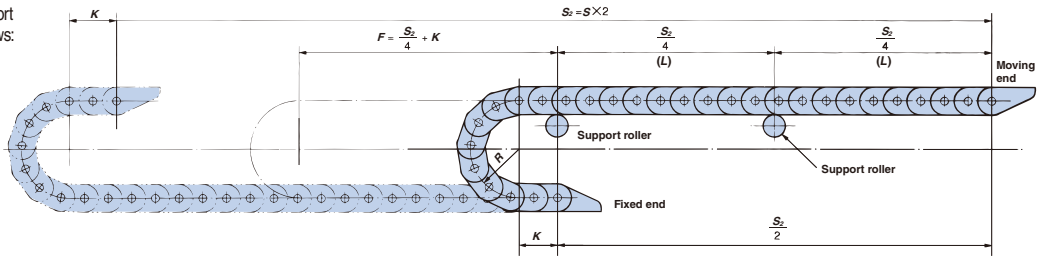

## 3. With support plates

Applicable to the TKC Series

(Travel speed 60 m/min or less)

( $S_2$ : travel length): The allowable travel length is 2-times the travel length when there is no support plate.

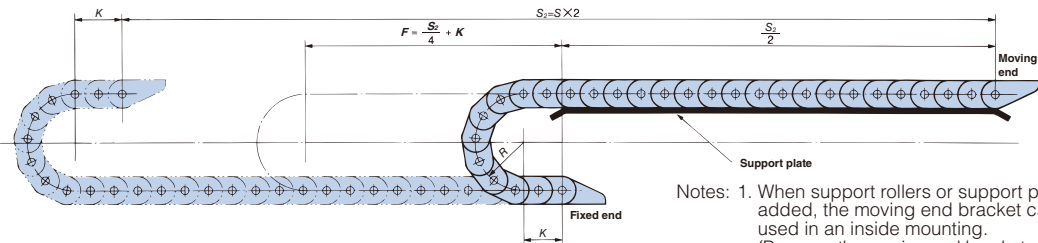

Notes: 1. When support rollers or support plates are added, the moving end bracket cannot be used in an inside mounting. (Because the moving end bracket will interfere with the rollers and plates.)  
2. Contact a Tsubaki representative when considering cable carriers other than the TKC Series.

## 4. Gliding arrangement

Applicable to the TKP Series/TKC Series

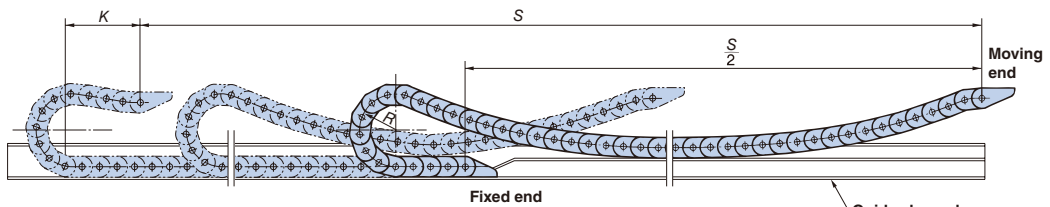

1. Features:

2. Applicable models:
3. Travel length:
4. Additional load:
5. Travel speed:
6. Guide method:

- A special installation method used for a long length that exceeds the load diagram.
- The moving end bracket is made to order and differs from the standard part in general. The mounting height of the moving end differs from the standard installation.

} Refer to the gliding arrangement page. (Page 127)

- A rail with step is required to guide a cable carrier that sags when it runs.
- The gaps to the left and right of the cable carrier and guide channels must be narrower than the standard installation.

5. Horizontal-vertical combined arrangement

Applicable to all models

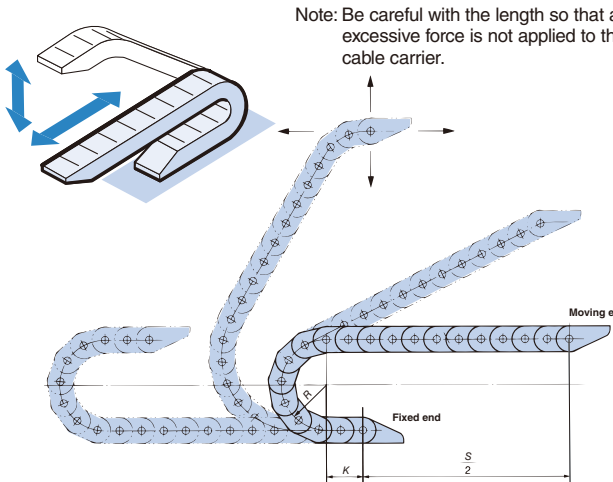

Note: Be careful with the length so that an excessive force is not applied to the cable carrier.

1. Features:

- Used when the cable carrier moves in two dimensions: forward/backward and up/down.
- Suitable for when the cable carrier moves forward/backward and the moving end height is raised higher than standard.
- Uses the standard product.

2. Travel length:

Same as standard arrangement (Support rollers cannot be used.)

3. Additional load:

4. Travel speed:

5. Guide method:

Same as standard arrangement

6. Notes:

The length of the cable carrier is longer than the standard installation. Decide on the length by taking into consideration the sloping section. In particular, be careful of the leeway length when the cable carrier moves back.

6. Vertical arrangement

Applicable to all models except the TKS Series

- ◆ Use this arrangement when the cable carrier moves in the vertical (up/down) direction.
- ◆ Guide channels are required on both sides to prevent the cable carrier from swaying or collapsing.

6-1. Vertical arrangement (standing)

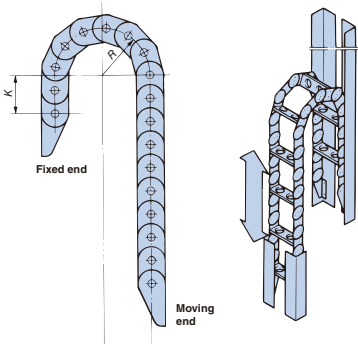

1. Features:

- An installation method in which the cable carrier is made to stand up.
- Not suited to long travel lengths because the mass of the cables and hoses is concentrated at the top of the bending radius.

2. Travel length:

Same as standard arrangement

3. Additional load:

Contact a Tsubaki representative for further information.

4. Travel speed:

Same as standard arrangement

5. Guide method:

- Both the moving and fixed sides require guide channels of a sufficient length to prevent the cable carrier from falling over. Contact a Tsubaki representative if the guide channels must be shortened.

- If the distance between the moving end and fixed end is greater than standard mounting height, the cable carrier will have an irregular shape and not a vertical arrangement (standing). Adjust the length of cables and hoses so they fit well in the cable carrier and then clamp both ends.

- The cable carrier has pretension to a certain degree in linear sections. Ensure sufficient space for the cable carrier because this pretension may appear after installation depending on the operating conditions.

6. Notes:

The TK Series and TKH Series use made-to-order pins to lessen pretension in the unsupported length section. The stay dimension (height) may be larger than standard for the TK Series and TKH Series.

6-2. Vertical arrangement (hanging)

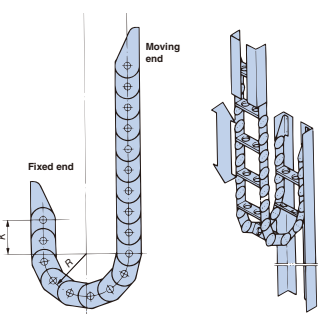

1. Features:

- An installation method in which the cable carrier is hanging.
- The load on the cable carrier becomes a tensile load so the load diagram cannot be used. Refer to the vertical arrangement (hanging) types table.

2. Travel length:

Refer to the following table.

3. Additional load:

Refer to the following table.

4. Travel speed:

Same as standard arrangement

5. Guide method:

- Adjust the length of cables and hoses so that the mass is not concentrated at the bottom of the bending radius and then clamp both ends. Ensure that cables and hoses are not riding up on the stays.

- Install guide channels on both sides to prevent swaying. Make the fixed end side the same length as the standard arrangement and make the moving end side 2 or 3 links longer than standard. Contact a Tsubaki representative if the guide channels must be shortened.

- The cable carrier has pretension to a certain degree in linear sections. Ensure sufficient space for the cable carrier because this pretension may appear after installation depending on the operating conditions.

6. Notes:

The TK Series and TKH Series use made-to-order pins to lessen pretension in the unsupported length section. The stay dimension (height) may be larger than normal for the TK Series and TKH Series.

■ Vertical arrangement (hanging) types table (Contact a Tsubaki representative about models not in this table.)

Model	Maximum travel length (m)	Maximum additional load (kg/m)	Maximum travel speed (m/min)	Model	Maximum travel length (m)	Maximum additional load (kg/m)	Maximum travel speed (m/min)	Model	Maximum travel length (m)	Maximum additional load (kg/m)	Maximum travel speed (m/min)
TKP13H10	6.0	0.6	300	TKR15H22	4.0	1.5	300	TKO70	8.0	15	60
TKP17H11	7.0	0.4	300	TKR20H28	9.0	2	300	TKO95	7.0	30	60
TKP18H14	7.0	1	300	TKR26H40	12.0	3	300	TK130	9.0	50	60
TKP18H15	7.0	1	300	TKR28H52	8.0	4	300	TK180	11.5	50	60
TKP25H15	5.5	1	300	TKR37H28	9.0	2	300	TKH250	87.0	50	60
TKP35H22	5.0	2	300	TKC28H30	19.0	2	300	TKFO55	8.0	2	60
TKP35H32	13.0	2	300	TKC34H25	8.5	5	300	TKFO85	9.0	4	60
TKP45H25	14.0	4	300	TKC47H36	11.0	8	300	TKF115	5.0	8	60
TKP58H39	10.0	6	300	TKC64H50	9.0	16	300	TKF175	3.5	11	60
TKP62H34	5.0	7.5	300	TKC85H68	4.5	35	300				
TKP68H46	10.0	6	300	TKC91H56	9.0	16	300				
TKP90H50	7.0	16	300	TKC91H80	10.5	40	300				
TKP91H56	9.0	16	300								
TKP91H80	11.0	40	300								
TKP125H74	5.5	22	300								

Notes: 1. When fixed end is at the center of the travel length.  
2. **Excluding the MW Type.**  
(Contact a Tsubaki representative regarding usage with the MW Type.)

# Examples of Cable Carrier Installations

## 7. Top-fixed arrangement (bottom movement)

Applicable to all models

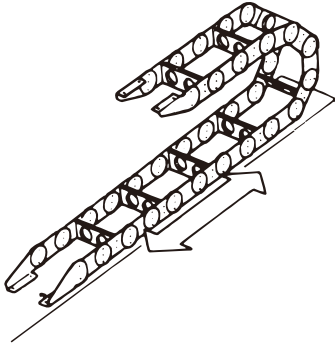

1. Features: The arrangement has the moving end on the bottom, which is the reverse of the standard arrangement.
2. Travel length: Same as standard arrangement
3. Additional load: Same as standard arrangement
4. Travel speed: Same as standard arrangement
5. Guide method:
  - Moving guide channels are required that move at the same time as the moving end on the bottom.
  - Contact a Tsubaki representative if the guide channels with a sufficient length cannot be installed.
  - When the guide channels cannot move, install traveling rollers on the cable carrier or install the cable carrier on the floor.
6. Notes: The TK Series, TKS Series, and TKH Series use made-to-order pins to lessen pretension in the unsupported length section.

## 8. Side mount arrangement

Applicable to the TK Series/TKP Series/TKC Series

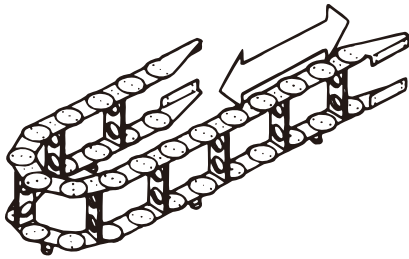

1. Features: The cable carrier is used on its side. This arrangement is suitable for when the connection surface for the steel brackets is lateral, when the travel length is long, and when there are space restrictions in the height direction.
2. Travel length: Refer to the following table.
3. Additional load: Refer to the following table.
4. Travel speed: Refer to the following table.
5. Guide method:
  - Guide channels are required at the bottom and both sides of the cable carrier. Contact a Tsubaki representative if the guide channels cannot be installed.
  - For the TK Series and TKH Series, install side rollers to guide the guide channels on both sides.
  - For the TK Series and TKH Series, casters or shoes are required on the bottom of the chain.

The plastic links of the TKP Series and TKC Series are made of engineering plastic and can slide as they are.
6. Notes: The TK Series and TKH Series use made-to-order pins to lessen pretension in the unsupported length section.

Side mount arrangement table (Contact a Tsubaki representative about models not in this table.)

Model	Maximum travel length (m)	Maximum additional load (kg/m)	Maximum travel speed (m/min)
TKP13H10	13	0.6	60
TKP17H11	15	0.4	60
TKP18H14	15	1	60
TKP18H15	15	1	60
TKP25H15	11	1	60
TKP35H22	11	2	60
TKP35H32	28	2	60
TKP45H25	48	2	60
TKP58H39	34	3	60
TKP62H34	21	3	60
TKP68H46	34	3	60
TKP90H50	42	4	60
TKP91H56	45	4	60
TKP91H80	64	8	60
TKP125H74	30	6	60

Model	Maximum travel length (m)	Maximum additional load (kg/m)	Maximum travel speed (m/min)
TKC28H30	41	2	60
TKC34H25	31	2	60
TKC47H36	43	3	60
TKC64H50	45	4	60
TKC85H68	31	6	60
TKC91H56	45	4	60
TKC91H80	56	8	60

Model	Maximum travel length (m)	Maximum additional load (kg/m)	Maximum travel speed (m/min)
TK070	30	14	30
TK095	30	18	30
TK130	60	24	30
TK180	80	26	30
TKH250	100	44	30

Note: **Excluding the MW Type.**  
(Contact a Tsubaki representative regarding usage with the MW Type.)

## 9. Horizontal circular travel arrangement

Applicable to the TK Series/TKP Series/TKC Series (Partial)

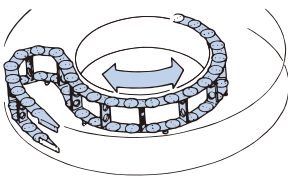

Fill in the inquiries sheet (page 165) for product selection.

1. Features:
  - Use this arrangement to guide cables and hoses that move back and forth in a circular travel on a flat channel.
  - The cable carrier is made-to-order and can bend in both directions. (The standard product cannot be used because it does not bend in the reverse direction.)
2. Maximum rotation angle: Approximately 360° (The maximum rotation angle may be larger or smaller depending on the conditions.)
3. Additional load: Refer to the side mount arrangement table above.
4. Travel speed: 30 m/min or less
5. Guide method:
  - Inside/outside guide channels and fixed guide channels, etc., are required.
  - For the TK Series, casters, guide shoes, guide rollers, and guide frames, etc., may be required.

## 10. Vertical circular travel arrangement

Applicable to the TK Series/TKP Series

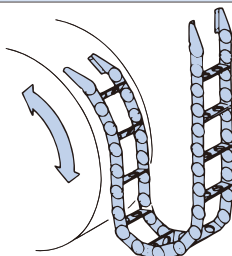

Fill in the inquiries sheet (page 165) for product selection.

1. Features:
  - Use this arrangement to guide cables and hoses that move back and forth vertically in a circular travel inside a vertical surface.
  - The cable carrier is made-to-order and can bend in both directions. (The standard product cannot be used because it cannot bend in the reverse direction.)
2. Maximum rotation angle: 180° to 200° (The maximum rotation angle may be greater depending on the conditions.)
3. Additional load: Refer to the vertical arrangement (hanging) types table.
4. Travel speed: 60 m/min or less
5. Guide method:
  - A drum with flange and fixed guide channels, etc., are required.
  - For the TK Series, guide rollers, etc., may be required.

11. Hanging with support bolts

Applicable to the TK Series

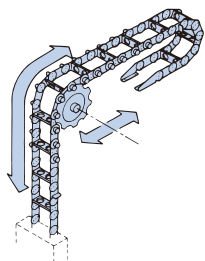

1. Features:
- Use this arrangement for a hanging switch box, etc., that must move vertically and in two dimensions (vertically and horizontally).
  - The center pin of the link plate is a made-to-order pin and driven by sprockets. The unsupported length is within the load diagram.
2. Travel length: Within the load diagram.
3. Additional load: 60 m/min or less
4. Travel speed: Sprockets are required.
5. Guide method: The stay dimension (height) may need to be larger than standard.
6. Notes:

12. Side roller type

Applicable to the TK Series (Excluding the TK070)

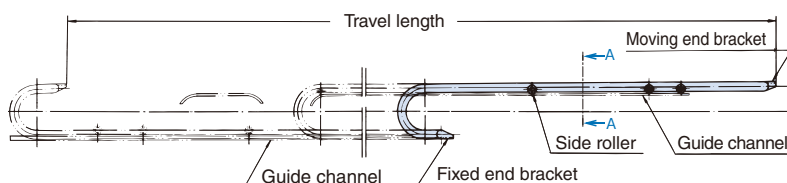
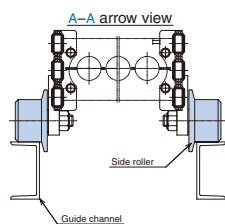

1. Features:
- Use this type when the travel length is long, when the additional load is large but 2 support rollers cannot be selected, and when attempting to decrease the unsupported length to improve service life.
  - Install side rollers in 1 to 5 locations on the sides of the chain.
2. Travel length: TK180: 50 m or less • TK130: 42 m or less • TK095: 24 m or less • And approximately 4-times or less of standard
3. Additional load: Within the load diagram.
4. Travel speed: 30 m/min or less
5. Guide method: Guide channels matched to the height of the cable carrier are required. Cut out positions where the side rollers go down.

13. Traveling roller type

Applicable to the TK Series (TK095, TK130, TK180 (R300 and higher))

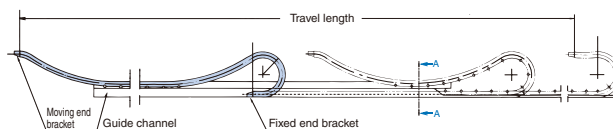
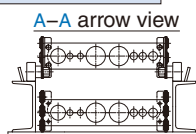

1. Features:
- Use this type when the travel length is long but support rollers or guide channels in the side roller type cause interference and when effectively using the installation space, such as for a traversing machine.
  - Install traveling rollers to the chain.
  - The cable carrier is made-to-order and bends in both directions.
2. Travel length: Same as support rollers in 2 locations in the catalog (cannot be larger than that).
3. Additional load: Within the load diagram.
4. Travel speed: 30 m/min or less
5. Guide method: Guide channels for running are required.

14. Nested arrangement

Applicable to the TK Series/TKH Series/TKP Series/TKC Series

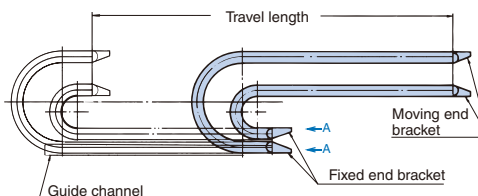
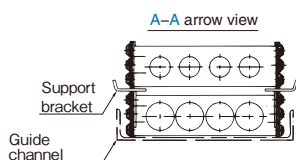

1. Features:
- Use this arrangement when the width of the installation space is insufficient and cables/hoses cannot be arranged side by side.
  - Multiple cable carriers with different bending radii can be nested. The same widths should be used.
  - For the TK Series and TKH Series, install brackets to support the inner cable carrier on the inside of the outer cable carrier.
  - For the TKC Series and TKP Series, the cable carriers can be directly stacked.
2. Travel length: Same as standard arrangement. However, support rollers cannot normally be used.
3. Additional load: Within the load diagram.
4. Travel speed: Same as standard arrangement
5. Guide method:
- TK Series and TKH Series are the same as standard.
  - TKC Series and TKP Series are the same as the gliding arrangement.
- The gap to the left and right of the cable carrier and guide channels must be narrower than the standard installation and use guide channels with higher sidewalls.
6. Notes: It is difficult to install support rollers for the outer cable carrier.



# Gliding Arrangement (Applicable Models: TKP Series/TKC Series)

## Gliding arrangement (gliding applications)

Gliding arrangements are designed to slide atop a guide channel when lengths exceeding the unsupported length shown in the load diagram are required.

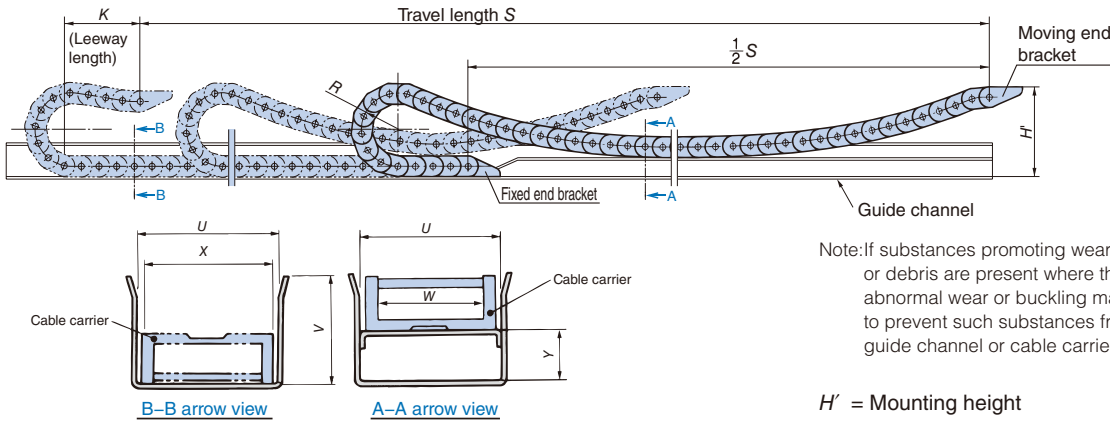

## Precautions for use

- Always install guide channels.  
The special Tsubaki guide channels on page 117 are convenient. Refer to the above figure to fabricate your own.
- Pay attention to the dimension  $H'$  (mounting height).  
This dimension  $H'$  differs from that in the layout in the standard arrangement. Use the dimensions on pages 129 and 130 for the mounting. If this dimension is too high or too low, the cable carrier may buckle or float up causing damage the cable carrier.
- Ensure ample leeway length (dimension  $K$ ).  
The leeway length differs from that in the layout in the standard arrangement. Set the number of links to be larger than or equal to the dimensions listed pages on 129 and 130. If this dimension is small, the links will be bent excessively to the reverse side when the moving end is at the position where the unsupported length is the shortest causing damage to the cable carrier.
- Made-to-order moving end bracket is required (except some models).  
**The made-to-order moving end bracket is made to bend in both directions.**  
For only the TKP45H25/TKP58H39/TKP68H46 (when using the steel brackets), the projection allowance of the pin differs from the standard model.

Model		Pin protrusion
TKP45H25	W38	Inner width $W + 40$
	Other width than the above	Inner width $W + 42$
TKP58H39		Inner width $W + 45$
TKP68H46 (When using steel brackets)		Inner width $W + 46$

- Use the FOA fixed end bracket.  
If the fixed end bracket is the FI, FIA, or FIB, the mounting section of the fixed end bracket and the top of the cable carrier will make contact as shown in the following figure (middle), so these brackets cannot be used for the gliding arrangement. The FOB or FC fixed end brackets also cannot be used because the fixed end bracket and guide channel will make contact as shown in the following figure (right).

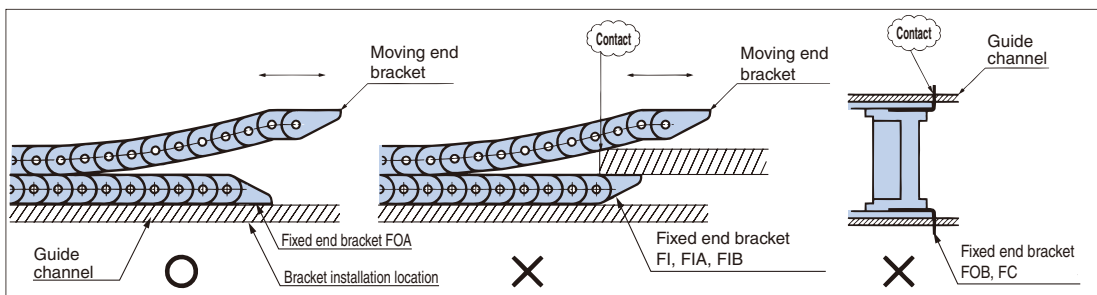

- Be careful not to place the machine to the left of the moving end bracket.  
If the machine is placed to the left of the moving end bracket, the machine and cable carrier may interfere with each other when the cable carrier travels to the left (refer to the following figure).

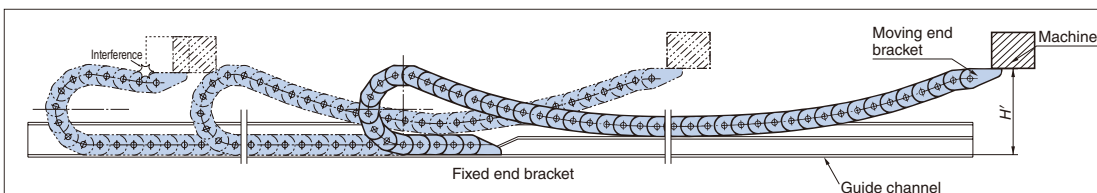



## Gliding arrangement/gliding shoes series (Patented)

The gliding arrangement/gliding shoes series contributes to overall reduced costs due to longer service life, power savings and lower running costs with long travel lengths and high-speed movement and a reduction in the environmental burden.



### Feature 1: Long service life

Adopting plastic materials with excellent slide characteristics and wear resistance\*, and the effect of increased wear allowance (amount of permissible wear), enable a longer service life for the cable carrier.

\*: Flame resistance standard: Plastics that conform to UL 94HB are used.

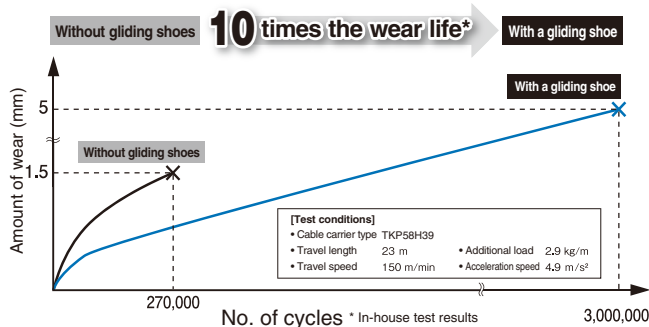
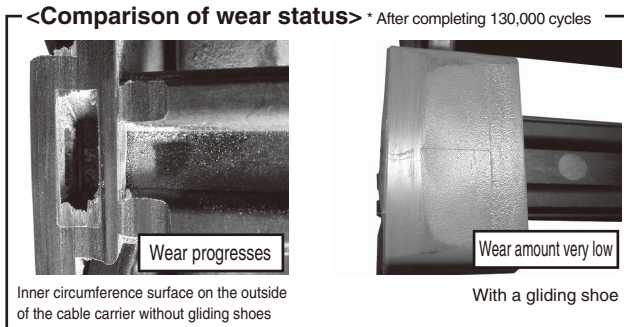

### Feature 2: Power-saving

Sliding friction of the cable carrier will be reduced; contributes to power-saving of the mechanical side drive force.

**Reduced 30% or more**

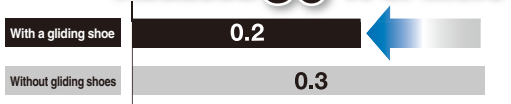

Coefficient of friction  $\mu$  \* The values are estimates, not guaranteed values.

### Feature 3: Lower running cost

If the gliding shoes have reached their wear life but there is no damage to the cable carrier chain link, it can continue to be used simply by replacing only the gliding shoes. Compared to when no gliding shoe is mounted, the cost for parts required for replacement and the man-hours can dramatically be reduced.

Note: See page 163 for allowable wear of gliding shoes.

## Models compatible with gliding shoes

Product series	Model	Pitch (mm)	Inner height (mm)	Inner width (mm)	Bending radius (mm)	Gliding shoe installation
TKP Series	TKP58H39	58	39	50/75/100/125	75/90/125/150/200	Option
	TKP68H46	68	46	75/100/125/150/175	75/100/125/150/200/250	Option
	TKP91H56 *	91	56	150/175/200/225/250/275/300/325/350/400/450/500	200/250/300	Necessary
	TKP91H80 *	91	80	150/175/200/225/250/275/300/325/350/400/450/500	200/250/300/350/400	Necessary
TKC Series	TKC91H56 *	91	56	150/200/250/300/350/400	200/250/300	Necessary
	TKC91H80 *	91	80	150/200/250/300/350/400	200/250/300/350/400	Necessary

\*: Fixed end brackets (plastic brackets) are made-to-order items (with gliding shoes).

# Gliding Arrangement

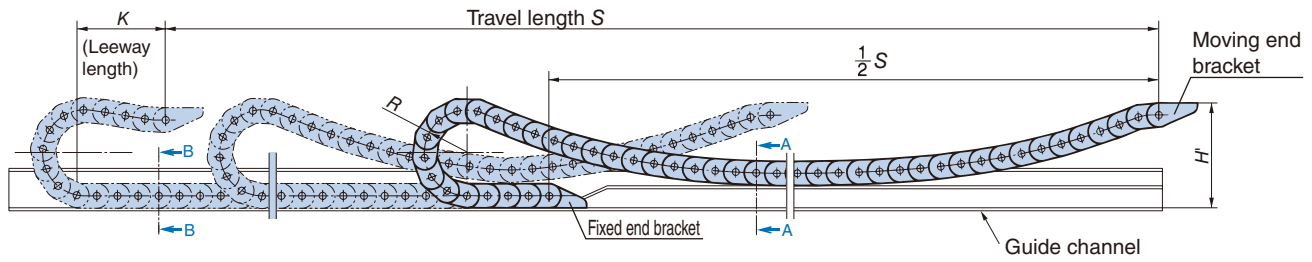

■ Gliding arrangements table (Open type)

Model	Pitch P (mm)	Inner height H (mm)	Bending radius R (mm)	Leeway length K (mm)	Maximum travel length $S_{max}$ (m)	Maximum additional load (kg/m)	Maximum travel speed (m/min)	Mounting height H' (mm)	Gliding shoe installation ●: Required △: Optional -: None	Plastic link/ gliding shoe allowable wear (mm) ( ) is gliding shoe	Moving end bracket		Inner width W (mm)	X (mm)	U <sup>+2</sup> <sub>-1</sub> (mm)	V (mm)	Y (mm)		
											Materials	Type							
TKP35H22 *3	35	22	37	100	20 to 40 *1 40 and longer *2	1.0	40	150	—	1.0	Engineering plastic	Standard	25 38 50	W+12	W+18	60	30		
			Made-to-order					63				77	83						
TKP45H25 *3	45	25	50	30 to 60 *1 60 and longer *2	2.0	120	190	—	1.5	Steel	Made-to-order	38	56	62	70	36			
							75					140					230		
							95					140					230		
							125					250					230		
							150					400					230		
							200					700					230		
TKP58H39 *3	58	39	60	45 to 75 *1 75 and longer *2	3.0	150	200	—	1.5 (5.0)	Steel	Made-to-order	50	W+21	W+27	100	With gliding shoe W+25	With gliding shoe W+31	52	
							75					190							200
							90					190							250
							125					220							250
							150					400							250
							200					600							250
TKP62H34	62.5	34	75	50 to 80 *1 80 and longer *2	3.0	120	200	—	1.0	Steel	Standard	150 200	W+22	W+28	108	54			
			Made-to-order																
							90				190						250		
							125				220						250		
							150				400						250		
TKP68H46 *3	68	46	75	45 to 75 *1 75 and longer *2	3.0	150	200	△	1.5 (5.0)	Engineering plastic or Steel	Made-to-order	75	W+22	W+28	126	With gliding shoe W+26	With gliding shoe W+32	63	
							100					190							200
							125					220							250
							150					400							250
							200					600							250
							250					750							300
TKP90H50	90	50	130	80 to 120 *1 120 and longer *2	4.0	150	300	—	1.5	Steel	Made-to-order	100	W+30	W+36	156	78			
							200					350					350		
							250					600					350		
TKP91H56 *6	91	56	200	80 to 120 *1 120 and longer *2	6.0	200	380	●	(7.0)	Engineering plastic + steel bush	Made-to-order*5	150 to 500 *8 (25 mm increments)	W+42	W+50	188	94			
							250					600					380		
							300					750					380		
TKP91H80 *6	91	80	200	100 to 120 *1 120 and longer *2	8.0	200	400	●	(7.0)	Engineering plastic + steel bush	Made-to-order*5	150 to 500 *8 (25 mm increments)	W+56	W+64	236	118			
							250					500					400		
							300					750					400		
							350					1000					400		
							400					1200					400		
TKP125H74	125	74	185	90 to 120 *1 120 and longer *2	6.0	150	400	—	1.5	Steel	Made-to-order	150	W+40	W+46	212	106			
							250					600					400		
							350					1000					400		

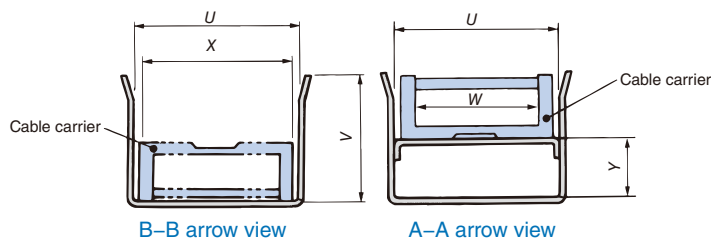

■ Gliding arrangements table (Closed type)

Model	Pitch P (mm)	Inner height H (mm)	Bending radius R (mm)	Leeway length K (mm)	Maximum travel length S <sub>max</sub> (m)	Maximum additional load (kg/m)	Maximum travel speed (m/min)	Mounting height H' (mm)	Gliding shoe installation ●: Required -: None	Plastic link/ gliding shoe allowable wear (mm) ( ) is gliding shoe	Moving end bracket		Inner width W (mm)	X (mm)	U <sub>-1</sub> <sup>2</sup> (mm)	V (mm)	Y (mm)
											Materials	Type					
TKC34H25	34	25	70	110	50 50 to 70 *1 70 and longer *2	2.0	150	200	—	1.0	Steel	Standard	50	W+20	W+30	80	40
			100	110				Made-to-order				90					
			150	200				Made-to-order				130					
TKC47H36	47	36	100	150	70 70 to 80 *1 80 and longer *2	3.0	200	250	—	1.0	Steel	Standard	80	W+26	W+36	110	55
			150	150				Made-to-order				160					
			200	400				Made-to-order									
			250	600				Made-to-order									
TKC64H50	64	50	135	200	80 80 to 120 *1 120 and longer *2	4.0	200	300	—	1.5	Steel	Made-to-order	110	W+30	W+40	150	75
			200	300				Made-to-order				220					
			250	500				Made-to-order									
			300	750				Made-to-order									
TKC85H68	85	68	180	260	90 90 to 120 *1 120 and longer *2	6.0	200	400	—	1.5	Steel	Made-to-order	150	W+36	W+46	200	100
			250	500				Made-to-order				200					
			350	1000				Made-to-order				300					
TKC91H56 *6	91	56	200	300	80 80 to 120 *1 120 and longer *2	6.0	200	380	●	(7.0)	Engineering plastic + steel bush	Made-to-order*5	150 to 400 *9 (50 mm increments)	W+42	W+50	188	94
			250	600				Made-to-order*5									
			300	750				Made-to-order*5									
TKC91H80 *6	91	80	200	380	100 100 to 120 *1 120 and longer *2	8.0	200	400	●	(7.0)	Engineering plastic + steel bush	Made-to-order*5	150 to 400 *9 (50 mm increments)	W+56	W+64	236	118
			250	500				Made-to-order*5									
			300	750				Made-to-order*5									
			350	1000				Made-to-order*5									
			400	1200				Made-to-order*5									

- ★1. Differs depending on the additional load. Contact a Tsubaki representative for further information.
- ★2. May be used depending on installation conditions. Contact a Tsubaki representative for further information.
- ★3. The inside openable stay type of the TKP35H22, TKP45H25, TKP58H39, and TKP68H46 cannot be used.
- ★4. TKP Series MW Type (low friction/anti-wear series) is not recommended.
- ★5. Fixed end brackets (plastic brackets) are made-to-order items (with gliding shoes).
- ★6. Fixed end brackets are made-to-order items (with gliding shoes).
- ★7. Use fixed end brackets covered by guide channel for TKP91 and TKC91.
- ★8. Inner width: 150/175/200/225/250/275/300/325/350/400/450/500 mm
- ★9. Inner width: 150/200/250/300/350/400 mm

### Calculating no. of links

$$\text{Number of links} = \frac{\frac{S}{2} + \pi R + 2K}{P}$$

When fixed end is at the center of the travel length. Always round up the value after calculating.

Calculation example: Using the TKP45H25-30W58R50 with a travel length of 10 m

$$P = 45, R = 50, K = 140, S = 10000$$

$$\text{Number of links} = \frac{\frac{10000}{2} + \pi \times 50 + 2 \times 140}{45} = 120.8 \Rightarrow 121$$

# Gliding Arrangement

## Model number

### TKP Series

# TKP45H25-30W58R125+120L-FOA-MOAGA

(1) Product name

Number of links

(2) Fixed end

(3) Moving end

(1) Product name	(2) Fixed end	(3) Moving end	
TKP35H22-30W R37	FO	MO/MI	
TKP35H22-30W R50		MOGA/MIGA	
TKP35H22-30W R75			
TKP35H22-30W R100			
TKP45H25-30W R R	FO/FOA		MOAGA/MIAGA/MOBGA/MIBGA/MCGA
TKP58H39-30W R R	FO/FOA	MOAGA/MIAGA/MOBGA/MIBGA/MCGA	
TKP62H34W R75	FOA	MOA/MIA	
TKP62H34W R90		MOAGA/MIAGA	
TKP62H34W R125			
TKP62H34W R150			
TKP62H34W R200			
TKP68H46-30W R R			FU/FOA
TKP90H50W R R	FOA		MOAGA/MIAGA
TKP91H56W R R -GA *	FUGA/FUCRGA	MUGA/MUCRGA	
TKP91H80W R R -GA *	FUGA/FUCRGA	MUGA/MUCRGA	
TKP125H74W R R	FOA	MOAGA/MIAGA	

\*: The TKP91H56 and TKP91H80 cable carrier is delivered with gliding shoes installed.

### Fixed end bracket/fitting

Model number	For cable carrier model number
TKP35H22W -FO	TKP35H22-30W R R
TKP45H25W -FO	TKP45H25-30W R R
TKP45H25-FOA	
TKP58H39W -FO	TKP58H39-30W R R
TKP58H39-FOA	
TKP62H34-FOA	TKP62H34W R R
TKP68H46W -FU	TKP68H46-30W R R
TKP68H46-FOA	
TKP90H50-FOA	TKP90H50W R R
TKP91H56W -FUGA	TKP91H56W R R -GA
TKP91H56W -FUCRGA	
TKP91H80W -FUGA	TKP91H80W R R -GA
TKP91H80W -FUCRGA	
TKP125H74-FOA	TKP125H74W R R

### Moving end bracket/fitting

Model number	For cable carrier model number
TKP35H22W -MO	TKP35H22W R R (R37, R50)
TKP35H22W -MI	
TKP35H22W -MOGA	TKP35H22W R R (R75, R100)
TKP35H22W -MIGA	
TKP45H25-MOAGA	TKP45H25-30W R R
TKP45H25-MIAGA	
TKP45H25-MOBGA	
TKP45H25-MIBGA	
TKP45H25-MCGA	
TKP58H39-MOAGA	
TKP58H39-MIAGA	
TKP58H39-MOBGA	
TKP58H39-MIBGA	
TKP58H39-MCGA	
TKP62H34-MOA	TKP62H34W R R (R75, R90)
TKP62H34-MIA	
TKP62H34-MOAGA	
TKP62H34-MIAGA	TKP62H34W R R (R125, R150, R200)
TKP68H46W -MUGA	
TKP68H46-MOAGA	
TKP68H46-MIAGA	TKP68H46-30W R R
TKP90H50-MOAGA	
TKP90H50-MIAGA	
TKP91H56W -MUGA	TKP91H56W R R -GA
TKP91H56W -MUCRGA	
TKP91H80W -MUGA	
TKP91H80W -MUCRGA	
TKP125H74-MOAGA	TKP125H74W R R
TKP125H74-MIAGA	

### Gliding shoe

Model number	For cable carrier model number
TKP58H39-GS	TKP58H39-30W R R (R125, R150, R200)
TKP58H39-GSR75	TKP58H39-30W R75
TKP58H39-GSR90	TKP58H39-30W R90
TKP68H46-GS	TKP68H46-30W R R (R125, R150, R200, R250)
TKP68H46-GSR75	TKP68H46-30W R75
TKP68H46-GSR100	TKP68H46-30W R100
TKP91H56-GS	TKP91H56W R R -GA
TKP91H80-GS	TKP91H80W R R -GA

Note: 2 gliding shoes are required per link.

### Gliding shoe install

Model number	For cable carrier model number
TKP58-GS-ASSY	TKP58H39-30W R R
TKP68-GS-ASSY	TKP68H46-30W R R

Notes: 1. The model number for work to install gliding shoes on the chain links.

2. The same quantity is required as the number of gliding shoes to install on the chain links.

See page 19 for ordering information

See pages 143 to 145 for product mass

## Model number

## TKC Series

**TKC47H36W80R150+120L-FOA-MOAGA**

(1) Product name

Number of links

(2) Fixed end

(3) Moving end

(1) Product name	(2) Fixed end	(3) Moving end
TKC34H25W■■R70	FOA	MOA/MIA/MC
TKC34H25W■■R100		MOAGA/MIAGA/MCGA
TKC34H25W■■R150		
TKC47H36W■■R100	FOA	MOA/MIA/MC
TKC47H36W■■R150		MOAGA/MIAGA/MCGA
TKC47H36W■■R200		
TKC47H36W■■R250		
TKC64H50W■■R■■	FOA	MOAGA/MIAGA/MCGA
TKC85H68W■■R■■	FOA	MOAGA/MIAGA/MCGA
TKC91H56W■■R■■-GA *	FUGA/FUCRGA	MUGA/MUCRGA
TKC91H80W■■R■■-GA *	FUGA/FUCRGA	MUGA/MUCRGA

★: The TKC91H56 and TKC91H80 cable carrier is delivered with gliding shoes installed.

## ■ Fixed end bracket/fitting

Model number	For cable carrier model number
TKC34H25-FOA	TKC34H25W■■R■■
TKC47H36-FOA	TKC47H36W■■R■■
TKC64H50-FOA	TKC64H50W■■R■■
TKC85H68-FOA	TKC85H68W■■R■■
TKC91H56W■■-FUGA	TKC91H56W■■R■■-GA
TKC91H56W■■-FUCRGA	
TKC91H80W■■-FUGA	
TKC91H80W■■-FUCRGA	

## ■ Gliding shoe

Model number	For cable carrier model number
TKC91H56-GS	TKC91H56W■■R■■-GA
TKC91H80-GS	TKC91H80W■■R■■-GA

Note: 2 gliding shoes are required per link.

## ■ Moving end bracket/fitting

Model number	For cable carrier model number
TKC34H25-MOA	TKC34H25W■■R70
TKC34H25-MIA	
TKC34H25-MC	
TKC34H25-MOAGA	TKC34H25W■■R■■ (R100, R150)
TKC34H25-MIAGA	
TKC34H25-MCGA	
TKC47H36-MOA	
TKC47H36-MIA	TKC47H36W■■R100
TKC47H36-MC	
TKC47H36-MOAGA	
TKC47H36-MIAGA	TKC47H36W■■R■■ (R150, R200, R250)
TKC47H36-MCGA	
TKC64H50-MOAGA	
TKC64H50-MIAGA	
TKC64H50-MCGA	TKC64H50W■■R■■
TKC85H68-MOAGA	TKC85H68W■■R■■
TKC85H68-MIAGA	
TKC85H68-MCGA	
TKC91H56W■■-MUGA	TKC91H56W■■R■■-GA
TKC91H56W■■-MUCRGA	
TKC91H80W■■-MUGA	TKC91H80W■■R■■-GA
TKC91H80W■■-MUCRGA	

See page 19 for ordering information

See page 149 for product mass



# Circular Travel Arrangements (Applicable Models: TKP Series/TKC Series/TK Series) (Patented)

## Circular travel arrangements

Circular travel arrangements can be used to connect cables and hoses to the rotating section of robots and other devices. Part of the structure of plastic cable carriers in circular travel arrangements differs from standard products. The external dimensions are the same as those of standard products. Contact a Tsubaki representative when using them.

◆ Chain links

Modifications are made to standard parts to allow them to bend in both directions.

◆ Brackets/steel brackets

For either the moving end bracket or the fixed end bracket, modifications are made to standard parts to allow them to bend in both directions.

However, standard parts may also be usable as is depending on the installation layout and model.

Parts manufactured by Tsubaki: Cable carrier (chain links, steel brackets, etc.)

Parts fabricated by the customer: Guide channels (inner circumference, outer circumference), distance

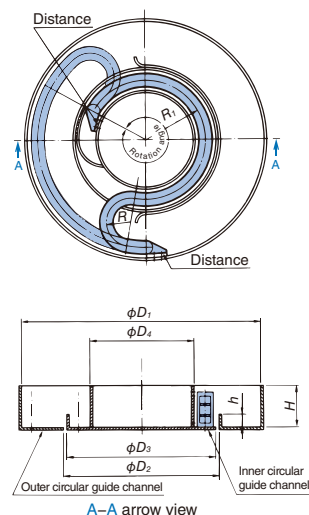

## Types/dimensions

■ If the inner circular drum diameter ( $\phi D_4$ ) has been determined

	Reverse bending radius $R_1$ (mm)	Outer circular drum diameter $D_1$ (mm)	$D_2$ (mm)	$D_3$ (mm)	Outer circular wall height $H$ (mm)	Guide height $h$ (mm)	Maximum travel speed (m/min)
TKP35H22 special type	$D_1/2+25$	$D_1+4R+100$	$D_1+106$	$D_1+100$	$W+25$	20	30
TKP45H25 special type	$D_1/2+30$	$D_1+4R+120$	$D_1+126$	$D_1+120$	$W+40$	30	
TKP58H39 special type	$D_1/2+35$	$D_1+4R+140$	$D_1+146$	$D_1+140$	$W+50$	50	
TKP68H46 special type	$D_1/2+40$	$D_1+4R+160$	$D_1+166$	$D_1+160$	$W+55$	50	
TKP62H34 special type	$D_1/2+40$	$D_1+4R+160$	$D_1+166$	$D_1+160$	$W+55$	50	
TKP90H50 special type	$D_1/2+50$	$D_1+4R+200$	$D_1+206$	$D_1+200$	$W+60$	50	
TKP125H74 special type	$D_1/2+65$	$D_1+4R+260$	$D_1+266$	$D_1+260$	$W+70$	50	

■ If the outer circular drum diameter ( $\phi D_1$ ) has been determined

	Reverse bending radius $R_1$ (mm)	Inner circular drum diameter $D_4$ (mm)	$D_2$ (mm)	$D_3$ (mm)	Outer circular wall height $H$ (mm)	Guide height $h$ (mm)	Maximum travel speed (m/min)
TKP35H22 special type	$D_1/2-2R-25$	$D_1-4R-100$	$D_1-4R+6$	$D_1-4R$	$W+25$	20	30
TKP45H25 special type	$D_1/2-2R-30$	$D_1-4R-120$	$D_1-4R+6$	$D_1-4R$	$W+40$	30	
TKP58H39 special type	$D_1/2-2R-35$	$D_1-4R-140$	$D_1-4R+6$	$D_1-4R$	$W+50$	50	
TKP68H46 special type	$D_1/2-2R-40$	$D_1-4R-160$	$D_1-4R+6$	$D_1-4R$	$W+55$	50	
TKP62H34 special type	$D_1/2-2R-40$	$D_1-4R-160$	$D_1-4R+6$	$D_1-4R$	$W+55$	50	
TKP90H50 special type	$D_1/2-2R-50$	$D_1-4R-200$	$D_1-4R+6$	$D_1-4R$	$W+60$	50	
TKP125H74 special type	$D_1/2-2R-65$	$D_1-4R-260$	$D_1-4R+6$	$D_1-4R$	$W+70$	50	

■ TKC34H25W130R70 sub-standard product

	Reverse bending radius $R_1$ (mm)	Outer circular drum diameter $D_1$ (mm)	$D_2$ (mm)	$D_3$ (mm)	$D_4$ (mm)	Outer circular wall height $H$ (mm)	Guide height $h$ (mm)	Maximum travel speed (m/min)
TKC34H25W130R70 special type	170	690	400	394	290	160	40	40
	140	630	340	334	230	160	40	
	205	750	470	464	350	160	40	

## Reference

Track of inner circular travel

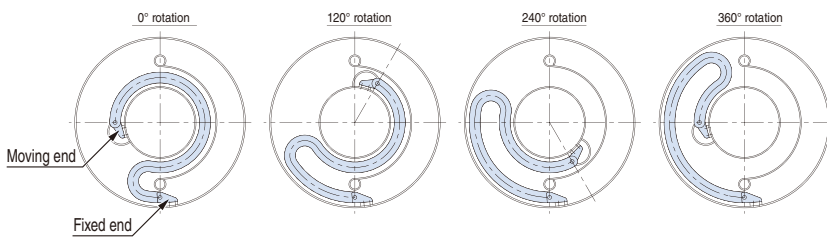

Track of outer circular travel

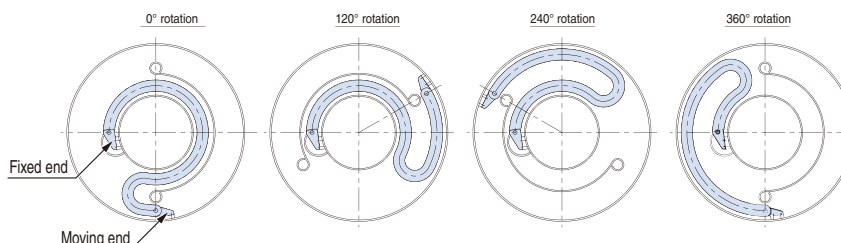

# Other Special Types

In addition to the gliding arrangement and circular travel arrangements, Tsubaki also manufactures cable carriers with special specifications to meet the needs of our customers. Contact a Tsubaki representative for further information.

## Straight type

Applicable to the TKP Series (Some models are excluded)

Standard cable carriers are manufactured so that the unsupported length section has pretension slightly when there is no load to take into consideration the additional load. The straight type is a special type that eliminates this pretension in the unsupported length section.

This is effective for when the pretension of the cable carrier is a problem in the installation space or when it negatively affects the appearance of the cable carrier.

Contact a Tsubaki representative about using the straight type.



Remark: Sagging will occur in the standard and straight types depending on the unsupported length and additional load.

## Aramid cover type (Patented)

Applicable to the Plastic Series / TKF Series (Some models are excluded)

This type protects the cable carrier, cables, and hoses from chips (cutting debris) produced by machine tools and metal fabrication tools.

### Advantages of aramid covers

1. Excellent heat resistance
2. Good resistance to cutting
3. Resistance to various chemicals and solvents  
(Contact a Tsubaki representative for the types of chemicals.)
4. High strength
5. Easy installation

### Aramid cover type

1. Temperature range: 200°C maximum (Chain 400°C/hook and loop fastener 200°C)
2. Fabric color: Yellow (aluminum vapor deposition also supported)
3. Fabric ends: Aramid stitching
4. Cover closing: Hook and loop fastener (A more robust fastener type is also available.)

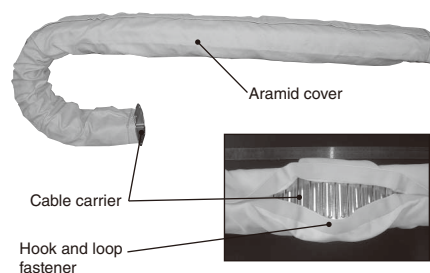

Contact a Tsubaki representative about using the aramid cover type.



## Antistatic type

Applicable to the TKP Series/TKC Series (Some models are excluded)

An antistatic type can be manufactured as a static electricity countermeasure for the Cable Carrier Plastic Series.

Contact a Tsubaki representative about using the antistatic type.

### Volume resistivity (estimate)

Antistatic type	$1 \times 10^8 \text{ to } 10^9 \Omega \cdot \text{cm}$
Standard type (estimate)	$1 \times 10^{13} \text{ to } 10^{15} \Omega \cdot \text{cm}$

## PVDF type

Applicable to the TKP Series/TKC Series (Some models are excluded)

The PVDF type that uses special fluoroplastics as a countermeasure for outgassing is manufactured for situations, such as in a vacuum, where the production of gas from the Cable Carrier Plastic Series is not desired.

This type also has excellent chemical resistance. Contact a Tsubaki representative about using and selecting this type.

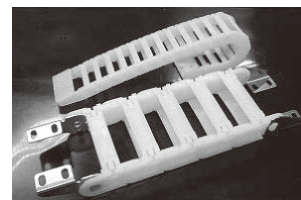

## Special color type

Applicable to the TKP Series/TKC Series (Some models are excluded)

The chain link color (black) of the Cable Carrier Plastic Series can be changed.

This is effective for the food industry where black is not desirable, when black would ruin the exterior of the product, and as a safety measure for a moving cable carrier.

Contact a Tsubaki representative about using the special color type.

## Flame-resistant type

Applicable to the TKP Series (Some models are excluded)

The Tsubaki Cable Carrier Plastic Series uses **UL standard: UL 94HB** class plastics based on the UL standard for the flame-resistant safety inspection of plastic products.

However, **UL standard: UL 94V-O** flame-resistant type products are also manufactured to meet requirements for higher flame resistance.

Contact a Tsubaki representative about using the flame-resistant type.

# Other Special Types

Contact a Tsubaki representative about using special types.

Note: It may not be possible to manufacture some special types depending on the cable carrier model.

## Stainless steel cover type

Applicable to the TK Series/TKH Series/TKS Series

This type adds stainless steel covers to the inner circumference and the outer circumference of cable carriers to prevent cables and hoses from being exposed to chips and dust.

- As a general rule, install a cover for the entire space when large chips and scraps will fall on the stainless steel covers because the covers will be scratched.
- There are gaps at both sides of the covers and between link plates.
- The center section cannot be fixed because the cover and link plates must slide. Install cover retainers to links without stays and ensure the stainless steel cover can move in length direction without coming off the chain.
- Always fix the stainless steel cover at both ends. Stainless steel covers are delivered without mounting holes. Drill holes according to the steel brackets and terminal box and fix appropriately. (Fabricated by the customer)

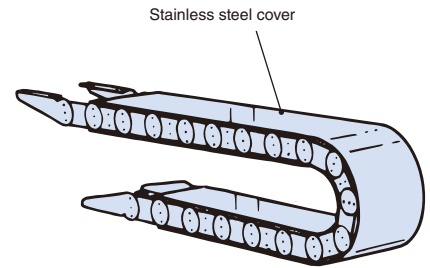

## Multiple chain type

Applicable to the TK Series/TKH Series/TKS Series

This type provides 2 strands of links as 3 or more strands.

- Use this type when there are many cables and hoses and the standard stay width is exceeded or the selection conditions are exceeded with a large mass. (However, the 3-row type is the same as the standard.)
- This type can also be used to separate and install types of cables and hoses. (Ex: Signal cables and power cables)

If support rollers are required, the center links must also be supported by the support rollers.

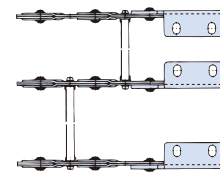

## Stainless steel type

Applicable to the TKP Series/TK Series/TKC Series/TKH Series

The steel parts used in the cable carrier can be changed to stainless steel parts when the cable carrier will be used in a corrosive atmosphere.

Applicable models:

- TK Series and TKH Series: Chains, stays, steel brackets
- TKP Series and TKC Series: Steel brackets

Used materials	
Chain plates	} SUS304
Steel brackets	
Pins	: SUS630
Stays	: Aluminum or SUS304

## Anti-dust series

Applicable to the TK Series/TKH Series

This series prevents clogging due to debris and chips, poor articulation due to the adherence of debris, and flopping during operation by widening the space between the 2 link plates that make up the cable carrier. Even in environments with flying and accumulating debris, this type can deliver smooth operation and improve durability in optimal conditions.

Note: Load is the same as the standard type.

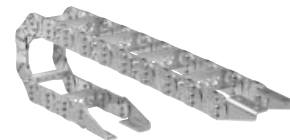

## Special surface treatment series

Applicable to the TK Series/TKH Series/TKS Series

This series features excellent corrosion resistance due to a special surface treatment applied to the link plates and connecting pins of the cable carrier.

This special surface treatment contributes to preventing the progression of corrosion in factories filled with fumes and steam, improving durability, and reducing the replacement frequency.

Note: Dimensions and load diagram are the same as the standard type. The cable carrier can be replaced without modifying the installation of existing products.

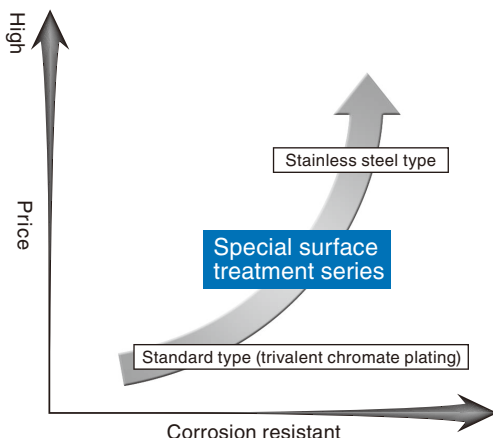

## Salt spray test result

Time until corrosion progresses is 3-times or longer than that of the standard type

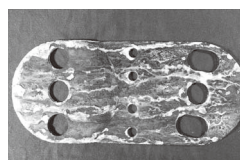

Standard type link plate



Special surface treatment series link plate

\* Example of in-house test results

Note: Full stainless steel cable carriers can also be manufactured for environments that demand a higher degree of corrosion resistance. (Excluding the frame of the TKS Series)



# Cable Carrier Internal Cross-Section Dimensions

## Cable carrier internal cross-section dimensions

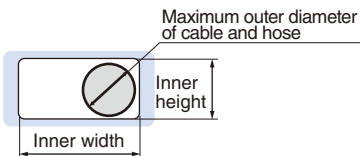

The maximum outer diameter of cable and hose does not take into consideration the allowable bending radius of cables and hoses. Select cable carriers by taking into account the allowable bending radius of the cables and hoses that will actually be installed. When installing a horizontal divider, always install 2 or more vertical dividers.

## TKP Series Internal Cross-Section Dimensions

### TKP13H10 to TKP25H15 internal cross-section dimensions

Pages 35 to 44

#### TKP13H10

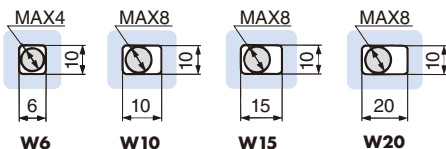

#### TKP17H11

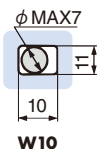

#### TKP18H14/TKP18H15

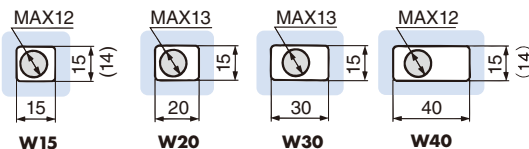

#### TKP25H15

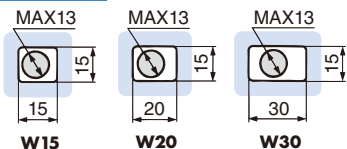

### TKP35H22 internal cross-section dimensions

Page 45

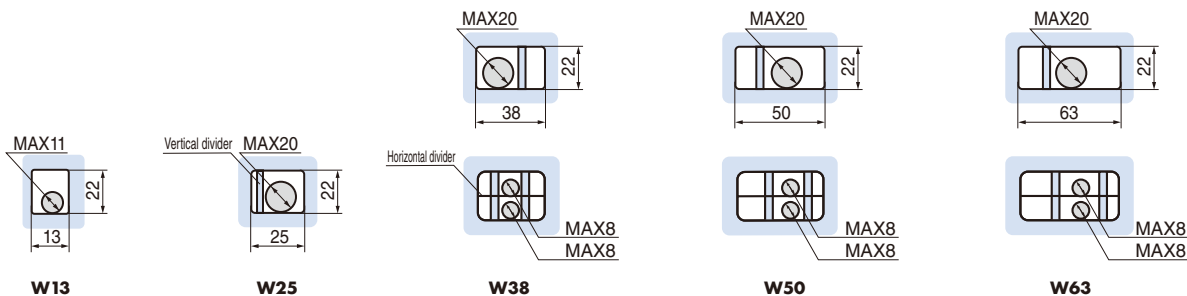

### TKP35H32 internal cross-section dimensions

Page 47

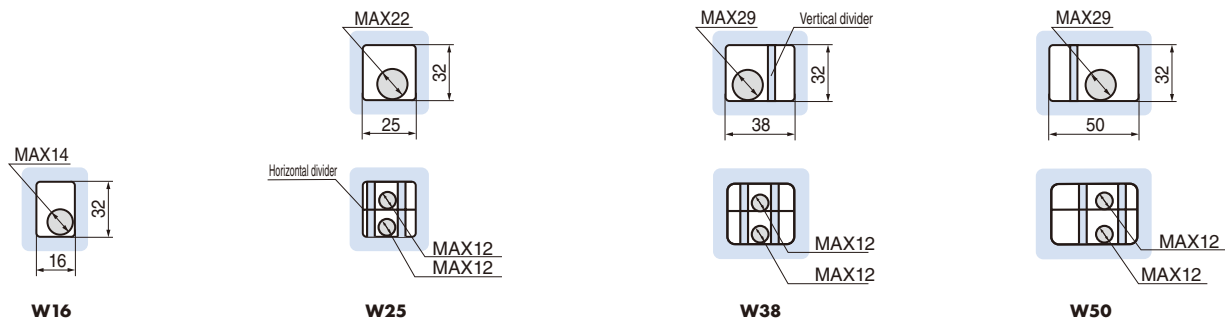

Note: Multi-layered separation with 3 or more layers is also possible. Refer to page 47 for further information.

### TKP45H25 internal cross-section dimensions

Page 49

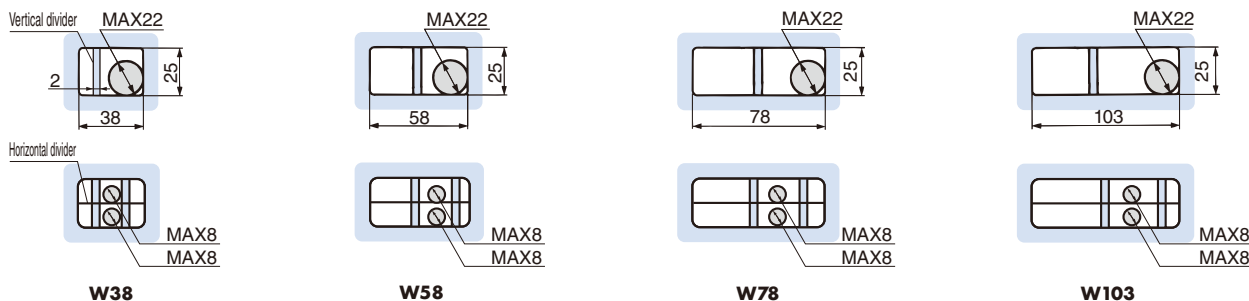

# Cable Carrier Internal Cross-Section Dimensions

## TKP58H39 internal cross-section dimensions

Page 51

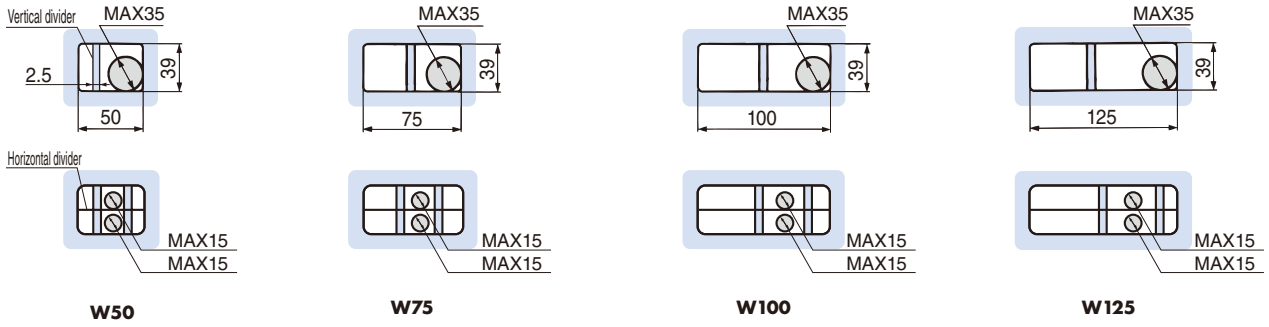

Note: 3-layered separation is also possible. Refer to page 51 for further information.

## TKP62H34 internal cross-section dimensions

Page 53

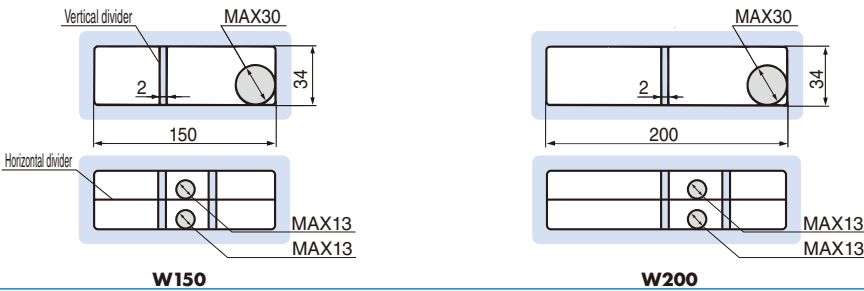

Note: 3-layered separation is also possible. Refer to page 53 for further information.

## TKP68H46 internal cross-section dimensions

Page 55

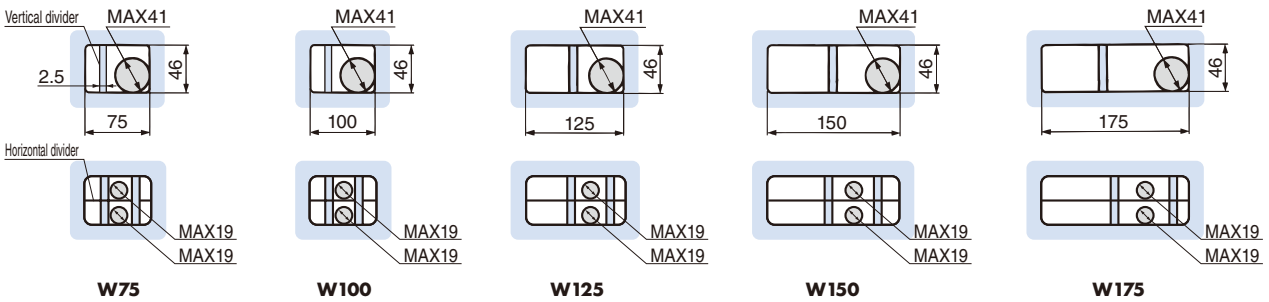

Note: Multi-layered separation with 3 or more layers is also possible. Refer to page 55 for further information.

## TKP90H50 internal cross-section dimensions

Page 57

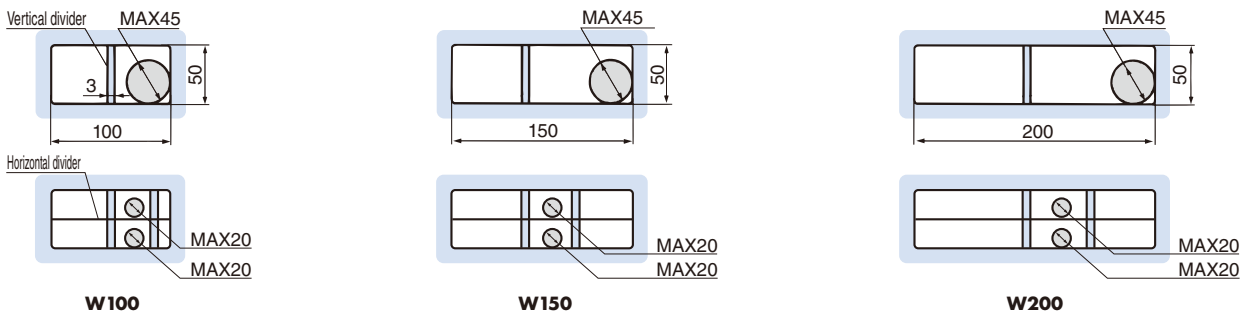

Note: 3-layered separation is also possible. Refer to page 57 for further information.

## TKP125H74 internal cross-section dimensions

Page 63

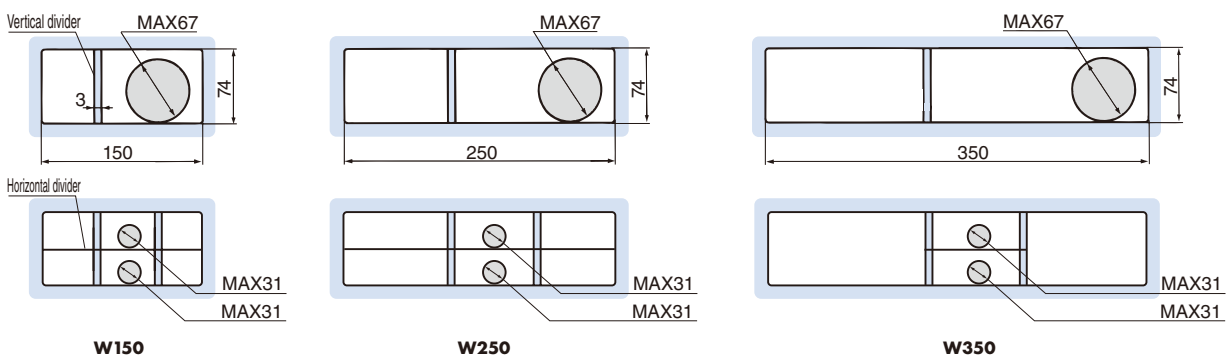

Note: 3-layered separation is also possible. Refer to page 63 for further information.

TKP91H56 internal cross-section dimensions

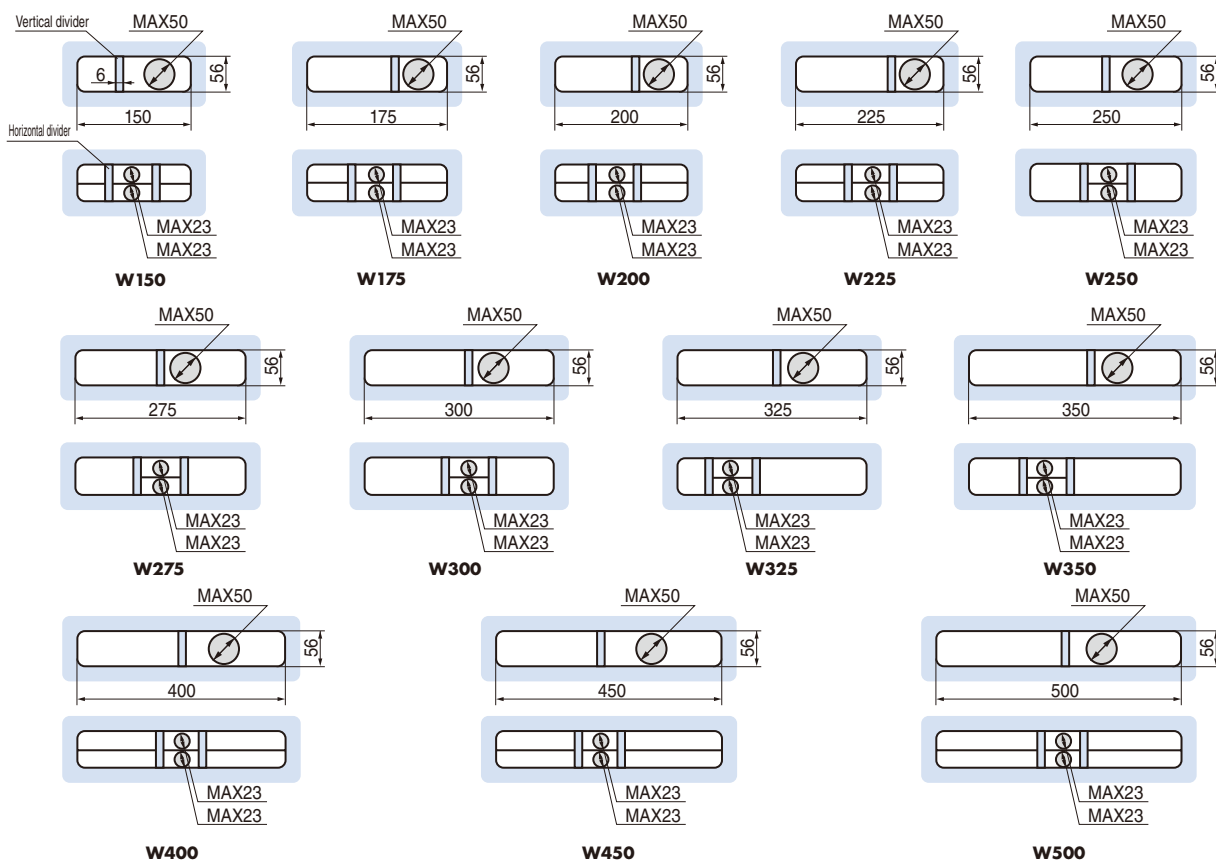

Note: Multi-layered separation with 3 or more layers is also possible. Refer to page 59 for further information.

TKP91H80 internal cross-section dimensions

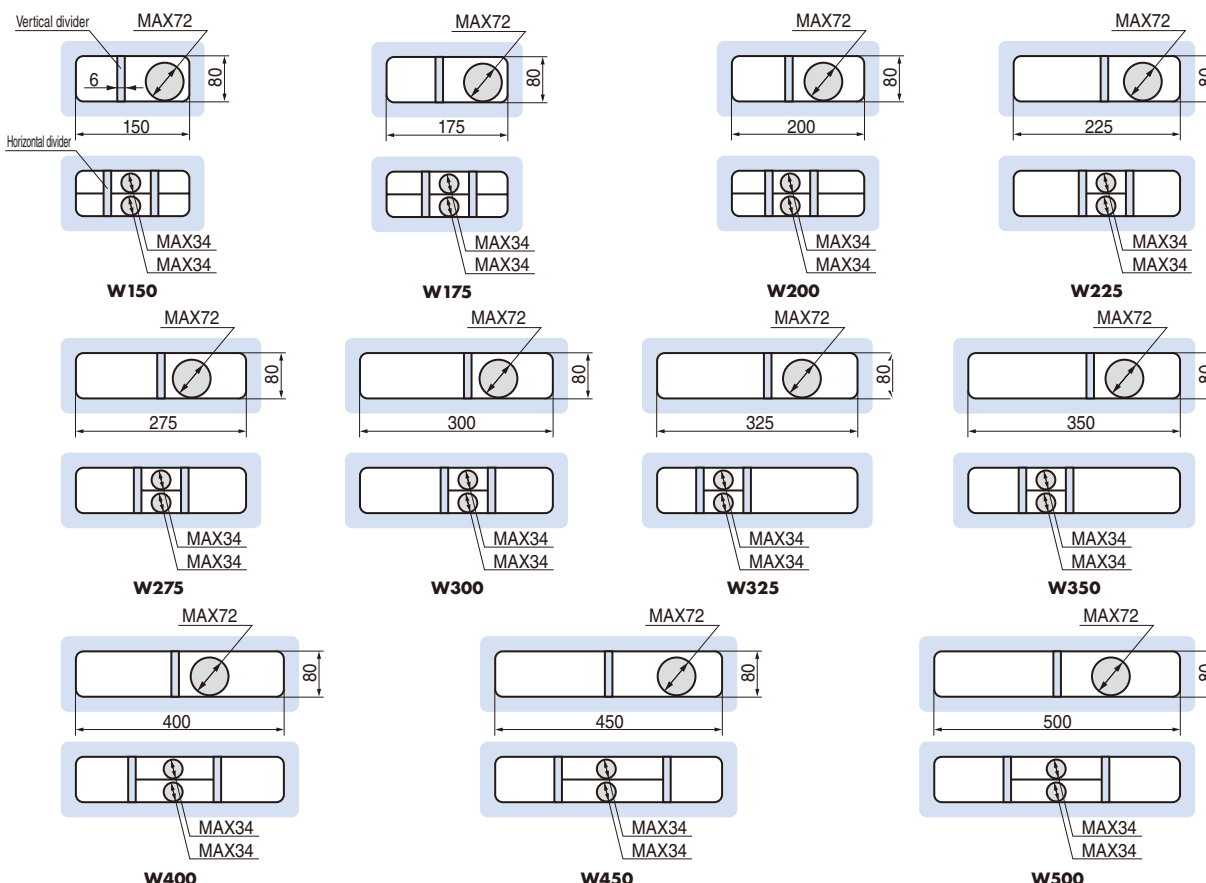

Note: Multi-layered separation with 3 or more layers is also possible. Refer to page 61 for further information.

# Cable Carrier Internal Cross-Section Dimensions

## TKR Series Internal Cross-Section Dimensions

### TKR15H22 internal cross-section dimensions

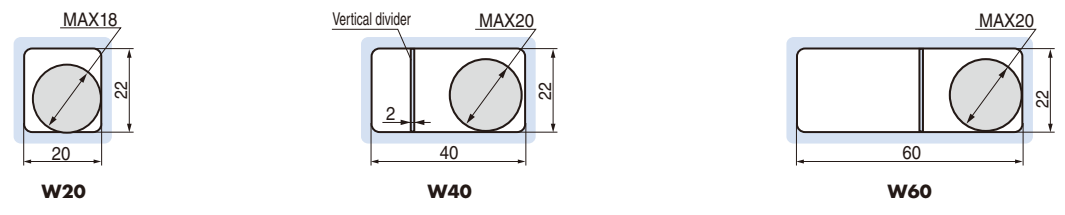

### TKR20H28 internal cross-section dimensions

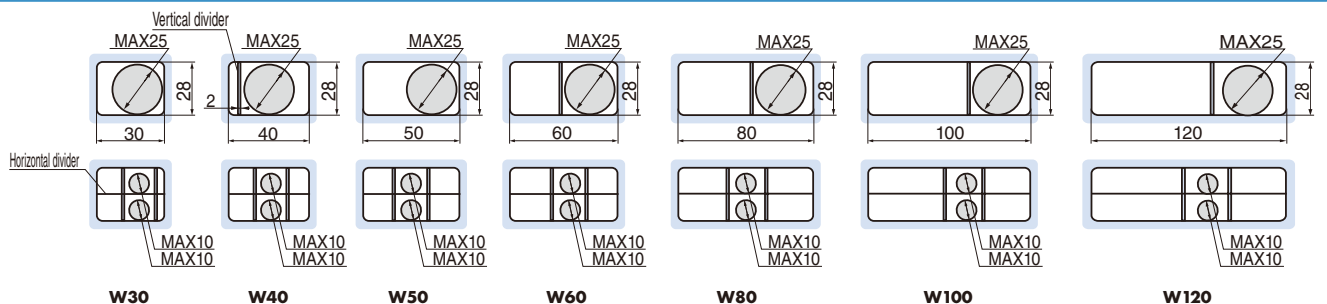

Note: 3-layered separation is also possible. Refer to page 69 for further information.

### TKR26H40 internal cross-section dimensions

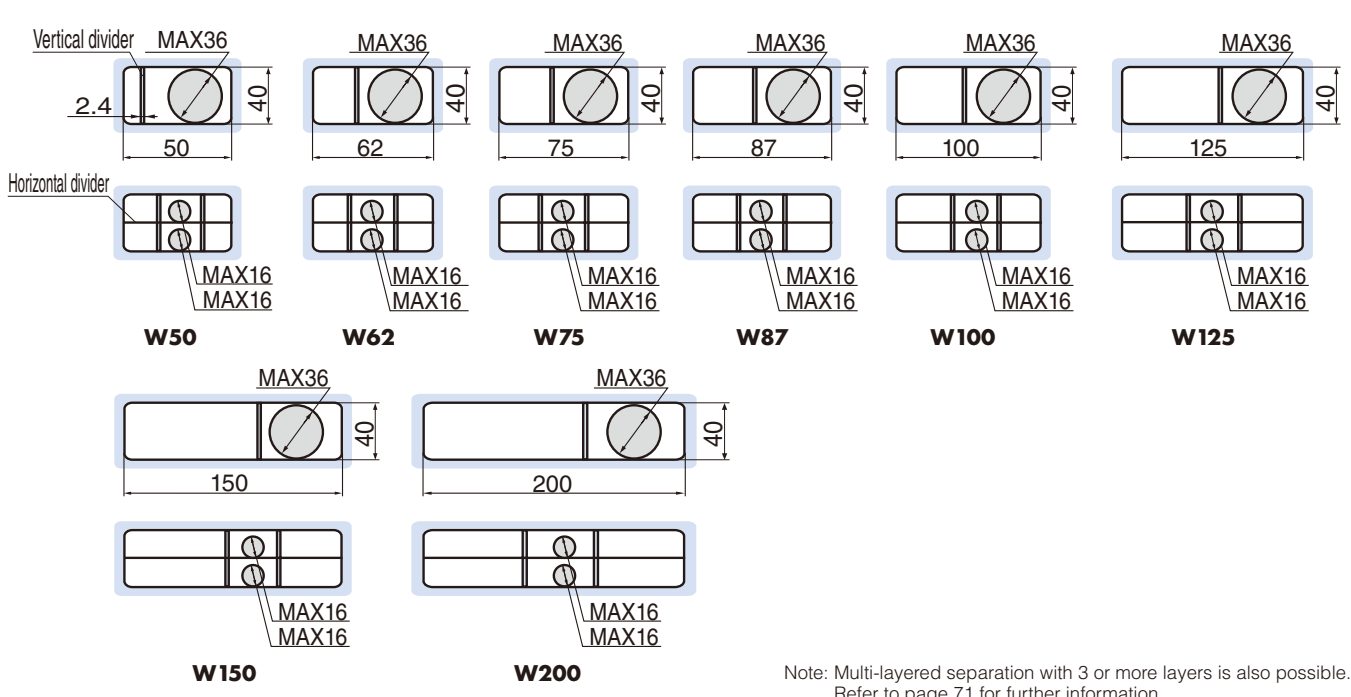

Note: Multi-layered separation with 3 or more layers is also possible. Refer to page 71 for further information.

TKR28H52 internal cross-section dimensions

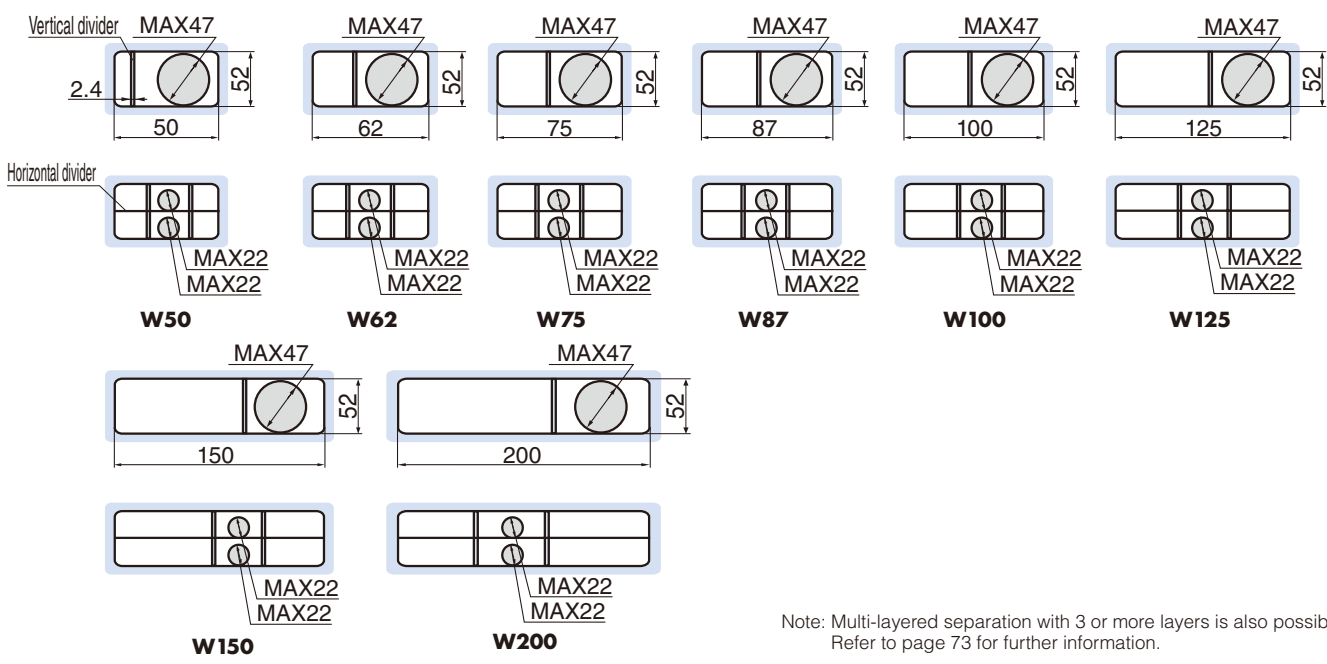

Note: Multi-layered separation with 3 or more layers is also possible. Refer to page 73 for further information.

TKR37H28 internal cross-section dimensions

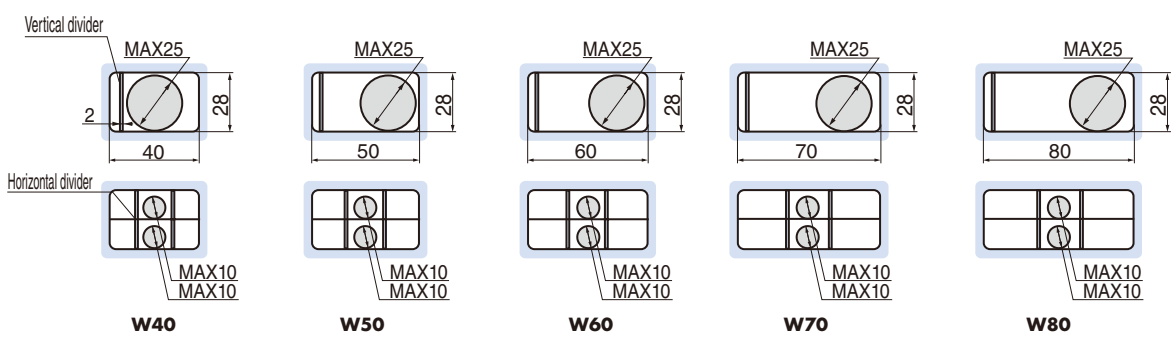

Note: 3-layered separation is also possible. Refer to page 75 for further information.

# Cable Carrier Internal Cross-Section Dimensions

## TKC Series Internal Cross-Section Dimensions

### TKC28H30 internal cross-section dimensions

Page 79



**W28**

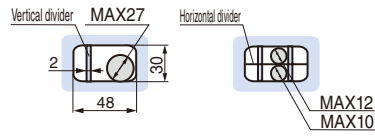

**W48**

### TKC34H25 internal cross-section dimensions

Page 81

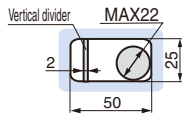

**W50**

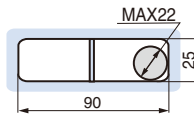

**W90**

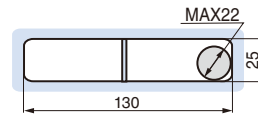

**W130**

### TKC47H36 internal cross-section dimensions

Page 83

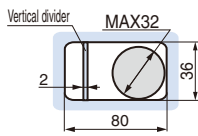

**W80**

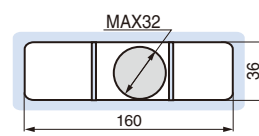

**W160**

### TKC64H50 internal cross-section dimensions

Page 85

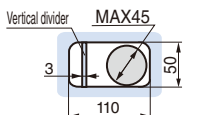

**W110**

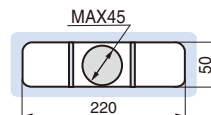

**W220**

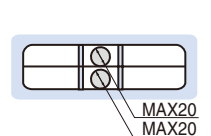
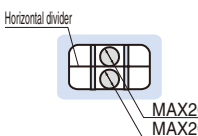

Note: 3-layered separation is also possible. Refer to page 85 for further information.

### TKC85H68 internal cross-section dimensions

Page 87

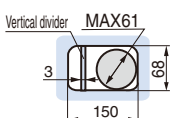

**W150**

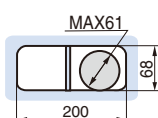

**W200**

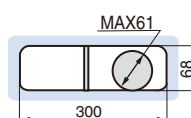

**W300**

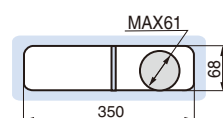

**W350**

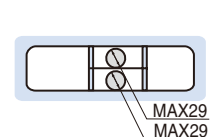
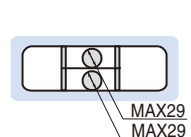
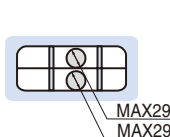
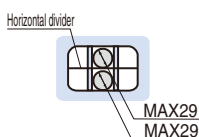

Note: 3-layered separation is also possible. Refer to page 87 for further information.

### TKC91H56 internal cross-section dimensions

Page 89

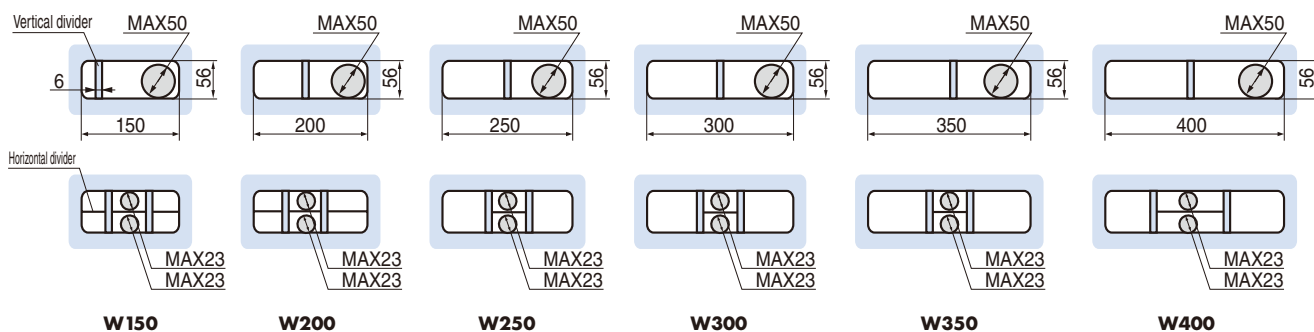

Note: Multi-layered separation with 3 or more layers is also possible. Refer to page 89 for further information.

### TKC91H80 internal cross-section dimensions

Page 91

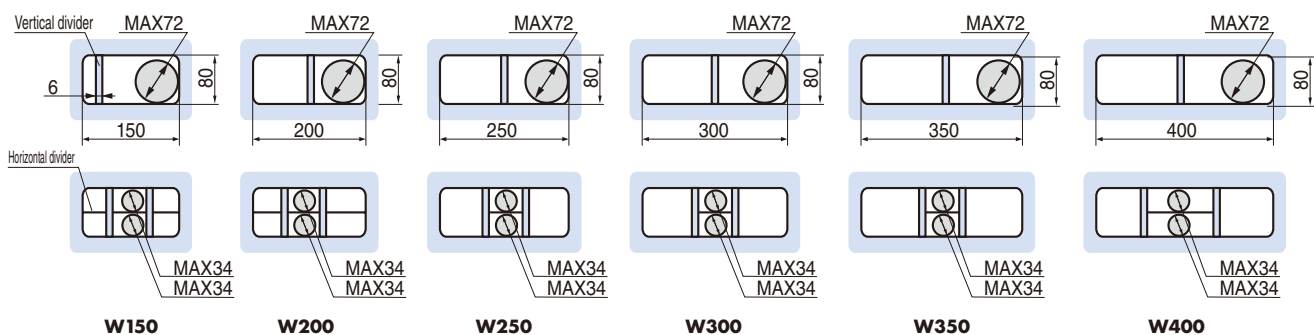

Note: Multi-layered separation with 3 or more layers is also possible. Refer to page 91 for further information.

## TKF Series Internal Cross-Section Dimensions

### TKF055 to TKF175 internal cross-section dimensions

Pages 107 to 110

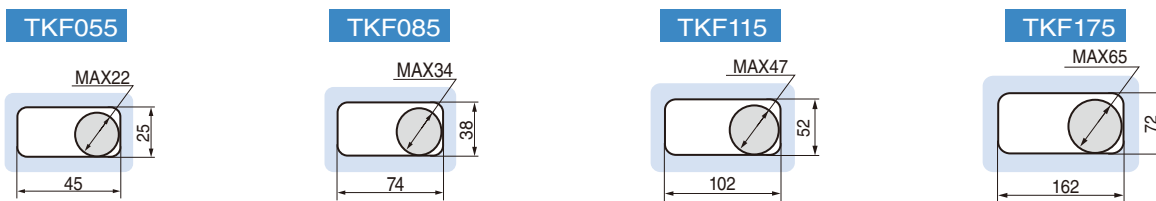

# Table of Product Masses

## TKP Series

Model number/ product name	Mass (kg/m)	Mass (g/each)	
TKP13H10-30W6R ■■	0.2	—	
TKP13H10-30W10R ■■TC		—	
TKP13H10-30W15R ■■		—	
TKP13H10-30W20R ■■TC		—	
TKP13H10W6-MO		1	—
TKP13H10W6-MI			—
TKP13H10W6-FO	—		
TKP13H10W6-FI	—		
TKP13H10W10TC-MO	2		—
TKP13H10W10TC-MI			—
TKP13H10W10TC-FO		—	
TKP13H10W10TC-FI		—	
TKP13H10W15-MO		3	—
TKP13H10W15-MI			—
TKP13H10W15-FO	—		
TKP13H10W15-FI	—		
TKP13H10W20TC-MO	3		—
TKP13H10W20TC-MI			—
TKP13H10W20TC-FO		—	
TKP13H10W20TC-FI		—	
TKP13H10-20W6R ■■		0.2	—
TKP13H10-20W10R ■■			—
TKP13H10-20W15R ■■	—		
TKP13H10-20W20R ■■	—		
TKP13H10W6-MO	1		—
TKP13H10W6-MI			—
TKP13H10W6-FO		—	
TKP13H10W6-FI		—	
TKP13H10W10-MO		2	—
TKP13H10W10-MI			—
TKP13H10W10-FO	—		
TKP13H10W10-FI	—		
TKP13H10W15-MO	3		—
TKP13H10W15-MI			—
TKP13H10W15-FO		—	
TKP13H10W15-FI		—	
TKP13H10W20-MO		3	—
TKP13H10W20-MI			—
TKP13H10W20-FO	—		
TKP13H10W20-FI	—		
TKP17H11-30W10R17	0.1		—
TKP17H11W10-MO	2		—
TKP17H11W10-MI		—	
TKP17H11W10-FO		—	
TKP17H11W10-FI		—	
TKP18H14-30W15R ■■TC		0.3	—
TKP18H15-30W20R ■■			—
TKP18H15-30W30R ■■	—		
TKP18H14-30W40R ■■TC	—		
TKP18H14W15TC-MO	7		—
TKP18H14W15TC-MI			—
TKP18H14W15TC-FO		—	
TKP18H14W15TC-FI		—	
TKP18H15W20-MO		5	—
TKP18H15W20-MI			—
TKP18H15W20-FO	—		
TKP18H15W20-FI	—		
TKP18H15W30-MO	6		—
TKP18H15W30-MI			—
TKP18H15W30-FO		—	
TKP18H15W30-FI		—	
TKP18H14W40TC-MO		6	—
TKP18H14W40TC-MI			—
TKP18H14W40TC-FO	—		
TKP18H14W40TC-FI	—		
TKP18H15-20W15R ■■	0.3		—
TKP18H15-20W20R ■■			—
TKP18H15-20W30R ■■		—	
TKP18H15-20W40R ■■		—	
TKP18H15W15-MO		5	—
TKP18H15W15-MI			—
TKP18H15W15-FO	—		
TKP18H15W15-FI	—		
TKP18H15W20-MO	5		—
TKP18H15W20-MI			—
TKP18H15W20-FO		—	
TKP18H15W20-FI		—	
TKP18H15W30-MO		6	—
TKP18H15W30-MI			—
TKP18H15W30-FO	—		
TKP18H15W30-FI	—		
TKP18H15W40-MO	6		—
TKP18H15W40-MI			—
TKP18H15W40-FO		—	
TKP18H15W40-FI		—	

Model number/ product name	Mass (kg/m)	Mass (g/each)		
TKP25H15-30W15R ■■	0.3	—		
TKP25H15-30W20R ■■		—		
TKP25H15-30W30R ■■		—		
TKP25H15W15-MO		6	—	
TKP25H15W15-MI			—	
TKP25H15W15-FO			—	
TKP25H15W15-FI	—			
TKP25H15W20-MO	8		—	
TKP25H15W20-MI			—	
TKP25H15W20-FO		—		
TKP25H15W20-FI		—		
TKP25H15W30-MO		15	—	
TKP25H15W30-MI			—	
TKP25H15W30-FO	—			
TKP25H15W30-FI	—			
TKP35H22-30W13R ■■	0.4		—	
TKP35H22-40W13R ■■			—	
TKP35H22-30W25R ■■		—		
TKP35H22-40W25R ■■		—		
TKP35H22-30W38R ■■		0.5	—	
TKP35H22-40W38R ■■			—	
TKP35H22-30W50R ■■	0.6		—	
TKP35H22-40W50R ■■			—	
TKP35H22-30W63R ■■			0.7	—
TKP35H22-40W63R ■■				—
TKP35H22W13-MO		13		—
TKP35H22W13-MI				—
TKP35H22W13-FO	—			
TKP35H22W13-FI	—			
TKP35H22W25-MO	15		—	
TKP35H22W25-MI			—	
TKP35H22W25-FO		—		
TKP35H22W25-FI		—		
TKP35H22W38-MO		18	—	
TKP35H22W38-MI			—	
TKP35H22W38-FO	—			
TKP35H22W38-FI	—			
TKP35H22W50-MO	20		—	
TKP35H22W50-MI			—	
TKP35H22W50-FO		—		
TKP35H22W50-FI		—		
TKP35H22W63-MO		24	—	
TKP35H22W63-MI			—	
TKP35H22W63-FO	—			
TKP35H22W63-FI	—			
TKP35H22-ST	—		1	
TKP35H22-HS38	—		3	
TKP35H22-HS50	—	3		
TKP35H22-HS63	—	4		
TKP35H32-30W16R ■■	0.2	—		
TKP35H32-30W25R ■■	0.6	—		
TKP35H32-40W25R ■■		—		
TKP35H32-30W38R ■■		0.7	—	
TKP35H32-40W38R ■■			—	
TKP35H32-30W50R ■■			0.8	—
TKP35H32-40W50R ■■				—
TKP35H32W16-MO	18			—
TKP35H32W16-MI				—
TKP35H32W16-FO		—		
TKP35H32W25-MO		24		—
TKP35H32W25-MI			—	
TKP35H32W25-FO			—	
TKP35H32W25-FI	—			
TKP35H32W25-MOCL	28		—	
TKP35H32W25-MICL			—	
TKP35H32W25-FOCL		30	—	
TKP35H32W25-FICL			—	
TKP35H32W38-MO			25	—
TKP35H32W38-MI				—
TKP35H32W38-FO	27			—
TKP35H32W38-FI				—
TKP35H32W38-MOCL		30		—
TKP35H32W38-MICL				—
TKP35H32W38-FOCL			32	—
TKP35H32W38-FICL				—
TKP35H32W50-MO	28			—
TKP35H32W50-MI				—
TKP35H32W50-FO		30		—
TKP35H32W50-FI				—
TKP35H32W50-MOCL			36	—
TKP35H32W50-MICL				—
TKP35H32W50-FOCL	38			—
TKP35H32W50-FICL				—
TKP35H32-ST		—		2
TKP35H32-HS25		—		1
TKP35H32-HS38		—	2	
TKP35H32-HS50		—	4	
TKP35H32W25-CL-P	—	4		
TKP35H32W38-CL-P	—	5		
TKP35H32W50-CL-P	—	8		

Model number/ product name	Mass (kg/m)	Mass (g/each)		
TKP45H25-30W38R ■■	0.9	—		
TKP45H25-40W38R ■■		—		
TKP45H25-30W58R ■■		1.1	—	
TKP45H25-40W58R ■■			—	
TKP45H25-30W78R ■■			1.3	—
TKP45H25-40W78R ■■				—
TKP45H25-30W103R ■■	1.5			—
TKP45H25-40W103R ■■				—
TKP45H25-MOA		—		—
TKP45H25-MIA		—		82
TKP45H25-MOB		—	—	
TKP45H25-MIB		—	—	
TKP45H25-MC	—	76		
TKP45H25-FOA	—	—		
TKP45H25-FIA	—	68		
TKP45H25-FOB	—	—		
TKP45H25-FIB	—	—		
TKP45H25-FC	—	54		
TKP45H25-MOAGA	—	—		
TKP45H25-MIAGA	—	91		
TKP45H25-MOBGA	—	—		
TKP45H25-MIBGA	—	—		
TKP45H25-MCGA	—	82		
TKP45H25W38-MO	—	59		
TKP45H25W38-MI	—	—		
TKP45H25W38-FO	—	49		
TKP45H25W38-FI	—	—		
TKP45H25W58-MO	—	67		
TKP45H25W58-MI	—	—		
TKP45H25W58-FO	—	57		
TKP45H25W58-FI	—	—		
TKP45H25W78-MO	—	75		
TKP45H25W78-MI	—	—		
TKP45H25W78-FO	—	75		
TKP45H25W78-FI	—	—		
TKP45H25W103-MO	—	85		
TKP45H25W103-MI	—	—		
TKP45H25W103-FO	—	85		
TKP45H25W103-FI	—	—		
TKP45H25-ST	—	2		
TKP45H25-HS38	—	3		
TKP45H25-HS58	—	4		
TKP45H25-HS78	—	6		
TKP45H25-HS103	—	8		
TKP58H39-30W50R ■■	1.6	—		
TKP58H39-40W50R ■■		—		
TKP58H39-30W75R ■■		1.7	—	
TKP58H39-40W75R ■■			—	
TKP58H39-30W100R ■■			1.8	—
TKP58H39-40W100R ■■				—
TKP58H39-30W125R ■■	1.9			—
TKP58H39-40W125R ■■				—
TKP58H39-MOA		—		127
TKP58H39-MIA		—		—
TKP58H39-MOB		—	128	
TKP58H39-MIB		—	—	
TKP58H39-MC	—	—		
TKP58H39-FOA	—	—		
TKP58H39-FIA	—	104		
TKP58H39-FOB	—	—		
TKP58H39-FIB	—	—		
TKP58H39-FC	—	96		
TKP58H39-MOAGA	—	—		
TKP58H39-MIAGA	—	127		
TKP58H39-MOBGA	—	—		
TKP58H39-MIBGA	—	—		
TKP58H39-MCGA	—	115		
TKP58H39W50-MO	—	115		
TKP58H39W50-MI	—	—		
TKP58H39W50-FO	—	95		
TKP58H39W50-FI	—	—		
TKP58H39W75-MO	—	130		
TKP58H39W75-MI	—	—		
TKP58H39W75-FO	—	110		
TKP58H39W75-FI	—	—		
TKP58H39W100-MO	—	145		
TKP58H39W100-MI	—	—		
TKP58H39W100-FO	—	125		
TKP58H39W100-FI	—	—		
TKP58H39W125-MO	—	160		
TKP58H39W125-MI	—	—		
TKP58H39W125-FO	—	140		
TKP58H39W125-FI	—	—		
TKP58H39-ST	—	4		
TKP58H39-HS50	—	4		
TKP58H39-HS75	—	6		
TKP58H39-HS100	—	8		
TKP58H39-HS125	—	10		



TKP Series

Model number/ product name	Mass (kg/m)	Mass (g/each)
TKP62H34W150R ■■	1.8	—
TKP62H34W200R ■■	2.1	—
TKP62H34-MOA	—	210
TKP62H34-MIA	—	—
TKP62H34-FOA	—	202
TKP62H34-FIA	—	—
TKP62H34-MOAGA	—	—
TKP62H34-MIAGA	—	210
TKP62H34-ST	—	4
TKP62H34-HS 150	—	12
TKP62H34-HS 200	—	14
TKP68H46-30W75R ■■	—	—
TKP68H46-40W75R ■■	1.9	—
TKP68H46-30W100R ■■	—	—
TKP68H46-40W100R ■■	2.0	—
TKP68H46-30W125R ■■	—	—
TKP68H46-40W125R ■■	2.1	—
TKP68H46-30W150R ■■	—	—
TKP68H46-40W150R ■■	2.2	—
TKP68H46-30W175R ■■	—	—
TKP68H46-40W175R ■■	2.4	—
TKP68H46W75-MU	—	133
TKP68H46W75-FU	—	127
TKP68H46W75-MUGA	—	133
TKP68H46W100-MU	—	143
TKP68H46W100-FU	—	137
TKP68H46W100-MUGA	—	143
TKP68H46W125-MU	—	154
TKP68H46W125-FU	—	147
TKP68H46W125-MUGA	—	154
TKP68H46W150-MU	—	163
TKP68H46W150-FU	—	157
TKP68H46W150-MUGA	—	163
TKP68H46W175-MU	—	174
TKP68H46W175-FU	—	167
TKP68H46W175-MUGA	—	174
TKP68H46-MOA	—	—
TKP68H46-MIA	—	200
TKP68H46-MC	—	206
TKP68H46-FOA	—	—
TKP68H46-FIA	—	174
TKP68H46-FC	—	182
TKP68H46-MOAGA	—	—
TKP68H46-MIAGA	—	209
TKP68H46-STAS	—	4
TKP68H46-STAL	—	4
TKP68H46-STBL	—	7
TKP68H46-STBE	—	7
TKP68H46-HS75	—	5
TKP68H46-HS100	—	7
TKP68H46-HS125	—	9
TKP68H46-HS150	—	11
TKP68H46-HS175	—	13
TKP68H46-EHS22	—	2
TKP68H46-EHS29	—	3
TKP68H46-EHS36	—	3
TKP68H46-EHS43	—	4
TKP68H46-EHS50	—	4
TKP68H46-EHS21.5	—	2
TKP68H46-EHS28.5	—	3
TKP68H46-EHS35.5	—	3
TKP68H46-EHS42.5	—	4
TKP68H46-EHS49.5	—	4
TKP68H46-EHS23.5	—	2
TKP68H46-EHS30.5	—	3
TKP68H46-EHS37.5	—	4
TKP68H46-EHS44.5	—	4
TKP68H46-EHS51.5	—	5
TKP68H46-EHS24	—	3
TKP68H46-EHS31	—	3
TKP68H46-EHS38	—	4
TKP68H46-EHS45	—	4
TKP68H46-EHS52	—	5
TKP68H46-EHS22.5	—	2
TKP68H46-EHS29.5	—	3
TKP68H46-EHS36.5	—	3
TKP68H46-EHS43.5	—	4
TKP68H46-EHS50.5	—	4
TKP90H50W100R ■■	2.6	—
TKP90H50W150R ■■	2.9	—
TKP90H50W200R ■■	3.1	—
TKP90H50-MOA	—	408
TKP90H50-MIA	—	—
TKP90H50-FOA	—	—
TKP90H50-FIA	—	374
TKP90H50-MOAGA	—	—
TKP90H50-MIAGA	—	403
TKP90H50-ST	—	7
TKP90H50-HS 100	—	10
TKP90H50-HS 150	—	12
TKP90H50-HS 200	—	14

Model number/ product name	Mass (kg/m)	Mass (g/each)
TKP91H56W150R ■■	4.3	—
TKP91H56W175R ■■	4.5	—
TKP91H56W200R ■■	4.6	—
TKP91H56W225R ■■	4.8	—
TKP91H56W250R ■■	5.0	—
TKP91H56W275R ■■	5.2	—
TKP91H56W300R ■■	5.4	—
TKP91H56W325R ■■	5.6	—
TKP91H56W350R ■■	5.7	—
TKP91H56W400R ■■	6.1	—
TKP91H56W450R ■■	6.5	—
TKP91H56W500R ■■	6.8	—
TKP91H56W150R ■■-GA	4.6	—
TKP91H56W175R ■■-GA	4.8	—
TKP91H56W200R ■■-GA	5.0	—
TKP91H56W225R ■■-GA	5.2	—
TKP91H56W250R ■■-GA	5.4	—
TKP91H56W275R ■■-GA	5.5	—
TKP91H56W300R ■■-GA	5.7	—
TKP91H56W325R ■■-GA	5.9	—
TKP91H56W350R ■■-GA	6.1	—
TKP91H56W400R ■■-GA	6.4	—
TKP91H56W450R ■■-GA	6.8	—
TKP91H56W500R ■■-GA	7.2	—
TKP91H56W150-MU	—	494
TKP91H56W150-FU	—	456
TKP91H56W150-MUCR	—	584
TKP91H56W150-FUCR	—	546
TKP91H56W150-MUGA	—	494
TKP91H56W150-FUGA	—	488
TKP91H56W150-MUCRGA	—	587
TKP91H56W150-FUCRGA	—	581
TKP91H56W175-MU	—	510
TKP91H56W175-FU	—	472
TKP91H56W175-MUCR	—	615
TKP91H56W175-FUCR	—	577
TKP91H56W175-MUGA	—	510
TKP91H56W175-FUGA	—	504
TKP91H56W175-MUCRGA	—	618
TKP91H56W175-FUCRGA	—	612
TKP91H56W200-MU	—	526
TKP91H56W200-FU	—	488
TKP91H56W200-MUCR	—	646
TKP91H56W200-FUCR	—	608
TKP91H56W200-MUGA	—	526
TKP91H56W200-FUGA	—	520
TKP91H56W200-MUCRGA	—	649
TKP91H56W200-FUCRGA	—	643
TKP91H56W225-MU	—	542
TKP91H56W225-FU	—	504
TKP91H56W225-MUCR	—	677
TKP91H56W225-FUCR	—	639
TKP91H56W225-MUGA	—	542
TKP91H56W225-FUGA	—	536
TKP91H56W225-MUCRGA	—	680
TKP91H56W225-FUCRGA	—	674
TKP91H56W250-MU	—	560
TKP91H56W250-FU	—	522
TKP91H56W250-MUCR	—	710
TKP91H56W250-FUCR	—	672
TKP91H56W250-MUGA	—	560
TKP91H56W250-FUGA	—	554
TKP91H56W250-MUCRGA	—	713
TKP91H56W250-FUCRGA	—	707
TKP91H56W275-MU	—	576
TKP91H56W275-FU	—	538
TKP91H56W275-MUCR	—	741
TKP91H56W275-FUCR	—	703
TKP91H56W275-MUGA	—	576
TKP91H56W275-FUGA	—	570
TKP91H56W275-MUCRGA	—	744
TKP91H56W275-FUCRGA	—	738
TKP91H56W300-MU	—	592
TKP91H56W300-FU	—	554
TKP91H56W300-MUCR	—	772
TKP91H56W300-FUCR	—	724
TKP91H56W300-MUGA	—	592
TKP91H56W300-FUGA	—	586
TKP91H56W300-MUCRGA	—	775
TKP91H56W300-FUCRGA	—	769
TKP91H56W325-MU	—	608
TKP91H56W325-FU	—	570
TKP91H56W325-MUCR	—	803
TKP91H56W325-FUCR	—	765
TKP91H56W325-MUGA	—	608
TKP91H56W325-FUGA	—	602
TKP91H56W325-MUCRGA	—	806
TKP91H56W325-FUCRGA	—	800

Model number/ product name	Mass (kg/m)	Mass (g/each)
TKP91H56W350-MU	—	626
TKP91H56W350-FU	—	588
TKP91H56W350-MUCR	—	836
TKP91H56W350-FUCR	—	798
TKP91H56W350-MUGA	—	626
TKP91H56W350-FUGA	—	620
TKP91H56W350-MUCRGA	—	839
TKP91H56W350-FUCRGA	—	833
TKP91H56W400-MU	—	658
TKP91H56W400-FU	—	620
TKP91H56W400-MUCR	—	898
TKP91H56W400-FUCR	—	860
TKP91H56W400-MUGA	—	658
TKP91H56W400-FUGA	—	652
TKP91H56W400-MUCRGA	—	901
TKP91H56W400-FUCRGA	—	895
TKP91H56W450-MU	—	692
TKP91H56W450-FU	—	654
TKP91H56W450-MUCR	—	962
TKP91H56W450-FUCR	—	924
TKP91H56W450-MUGA	—	692
TKP91H56W450-FUGA	—	686
TKP91H56W450-MUCRGA	—	965
TKP91H56W450-FUCRGA	—	959
TKP91H56W500-MU	—	724
TKP91H56W500-FU	—	686
TKP91H56W500-MUCR	—	1,024
TKP91H56W500-FUCR	—	996
TKP91H56W500-MUGA	—	724
TKP91H56W500-FUGA	—	718
TKP91H56W500-MUCRGA	—	1,027
TKP91H56W500-FUCRGA	—	1,021
TKP91H56-ST5	—	15
TKP91H56-STL	—	15
TKP91H56-STE	—	12
TKP91H56-HS150	—	7
TKP91H56-HS175	—	8
TKP91H56-HS200	—	9
TKP91H56-EHS24	—	2
TKP91H56-EHS30	—	3
TKP91H56-EHS36	—	4
TKP91H56-EHS42	—	4
TKP91H56-EHS48	—	5
TKP91H56-EHS54	—	5
TKP91H56-EHS22	—	2
TKP91H56-EHS28	—	3
TKP91H56-EHS34	—	3
TKP91H56-EHS40	—	4
TKP91H56-EHS46	—	4
TKP91H56-EHS52	—	5
TKP91H56-EHS22.5	—	2
TKP91H56-EHS28.5	—	3
TKP91H56-EHS34.5	—	3
TKP91H56-EHS40.5	—	4
TKP91H56-EHS46.5	—	4
TKP91H56-EHS52.5	—	5
TKP91H56-EHS23	—	2
TKP91H56-EHS29	—	3
TKP91H56-EHS35	—	4
TKP91H56-EHS41	—	4
TKP91H56-EHS47	—	5
TKP91H56-EHS53	—	5
TKP91H56-EHS23.5	—	2
TKP91H56-EHS29.5	—	3
TKP91H56-EHS35.5	—	4
TKP91H56-EHS41.5	—	4
TKP91H56-EHS47.5	—	5
TKP91H56-EHS53.5	—	5

# Table of Product Masses

## TKP Series

Model number/ product name	Mass (kg/m)	Mass (g/each)
TKP91H80W150R■	6.7	—
TKP91H80W175R■	6.8	—
TKP91H80W200R■	7.0	—
TKP91H80W225R■	7.2	—
TKP91H80W250R■	7.4	—
TKP91H80W275R■	7.5	—
TKP91H80W300R■	7.7	—
TKP91H80W325R■	7.9	—
TKP91H80W350R■	8.1	—
TKP91H80W400R■	8.5	—
TKP91H80W450R■	8.8	—
TKP91H80W500R■	9.2	—
TKP91H80W150R■-GA	7.0	—
TKP91H80W175R■-GA	7.1	—
TKP91H80W200R■-GA	7.3	—
TKP91H80W225R■-GA	7.5	—
TKP91H80W250R■-GA	7.7	—
TKP91H80W275R■-GA	7.9	—
TKP91H80W300R■-GA	8.0	—
TKP91H80W325R■-GA	8.2	—
TKP91H80W350R■-GA	8.4	—
TKP91H80W400R■-GA	8.8	—
TKP91H80W450R■-GA	9.1	—
TKP91H80W500R■-GA	9.5	—
TKP91H80W150-MU	—	705
TKP91H80W150-FU	—	705
TKP91H80W150-MUCR	—	795
TKP91H80W150-FUCR	—	795
TKP91H80W150-MUGA	—	796
TKP91H80W150-FUGA	—	828
TKP91H80W150-MUCRGA	—	889
TKP91H80W150-FUCRGA	—	921
TKP91H80W175-MU	—	720
TKP91H80W175-FU	—	720
TKP91H80W175-MUCR	—	825
TKP91H80W175-FUCR	—	825
TKP91H80W175-MUGA	—	812
TKP91H80W175-FUGA	—	844
TKP91H80W175-MUCRGA	—	920
TKP91H80W175-FUCRGA	—	952
TKP91H80W200-MU	—	735
TKP91H80W200-FU	—	735
TKP91H80W200-MUCR	—	855
TKP91H80W200-FUCR	—	855
TKP91H80W200-MUGA	—	828
TKP91H80W200-FUGA	—	860
TKP91H80W200-MUCRGA	—	951
TKP91H80W200-FUCRGA	—	983
TKP91H80W225-MU	—	750
TKP91H80W225-FU	—	750
TKP91H80W225-MUCR	—	885
TKP91H80W225-FUCR	—	885
TKP91H80W225-MUGA	—	844
TKP91H80W225-FUGA	—	876
TKP91H80W225-MUCRGA	—	982
TKP91H80W225-FUCRGA	—	1,014
TKP91H80W250-MU	—	765
TKP91H80W250-FU	—	765
TKP91H80W250-MUCR	—	915
TKP91H80W250-FUCR	—	915
TKP91H80W250-MUGA	—	862
TKP91H80W250-FUGA	—	894
TKP91H80W250-MUCRGA	—	1,015
TKP91H80W250-FUCRGA	—	1,047
TKP91H80W275-MU	—	780
TKP91H80W275-FU	—	780
TKP91H80W275-MUCR	—	945
TKP91H80W275-FUCR	—	945
TKP91H80W275-MUGA	—	878
TKP91H80W275-FUGA	—	910
TKP91H80W275-MUCRGA	—	1,046
TKP91H80W275-FUCRGA	—	1,078
TKP91H80W300-MU	—	795
TKP91H80W300-FU	—	795
TKP91H80W300-MUCR	—	975
TKP91H80W300-FUCR	—	975
TKP91H80W300-MUGA	—	894
TKP91H80W300-FUGA	—	926
TKP91H80W300-MUCRGA	—	1,077
TKP91H80W300-FUCRGA	—	1,109
TKP91H80W325-MU	—	910
TKP91H80W325-FU	—	910
TKP91H80W325-MUCR	—	1,005
TKP91H80W325-FUCR	—	1,005
TKP91H80W325-MUGA	—	910
TKP91H80W325-FUGA	—	942
TKP91H80W325-MUCRGA	—	1,108
TKP91H80W325-FUCRGA	—	1,140

Model number/ product name	Mass (kg/m)	Mass (g/each)
TKP91H80W350-MU	—	825
TKP91H80W350-FU	—	825
TKP91H80W350-MUCR	—	1,035
TKP91H80W350-FUCR	—	1,035
TKP91H80W350-MUGA	—	928
TKP91H80W350-FUGA	—	960
TKP91H80W350-MUCRGA	—	1,141
TKP91H80W350-FUCRGA	—	1,173
TKP91H80W400-MU	—	855
TKP91H80W400-FU	—	855
TKP91H80W400-MUCR	—	1,095
TKP91H80W400-FUCR	—	1,095
TKP91H80W400-MUGA	—	960
TKP91H80W400-FUGA	—	992
TKP91H80W400-MUCRGA	—	1,203
TKP91H80W400-FUCRGA	—	1,235
TKP91H80W450-MU	—	885
TKP91H80W450-FU	—	885
TKP91H80W450-MUCR	—	1,155
TKP91H80W450-FUCR	—	1,155
TKP91H80W450-MUGA	—	994
TKP91H80W450-FUGA	—	1,026
TKP91H80W450-MUCRGA	—	1,267
TKP91H80W450-FUCRGA	—	1,299
TKP91H80W500-MU	—	915
TKP91H80W500-FU	—	915
TKP91H80W500-MUCR	—	1,215
TKP91H80W500-FUCR	—	1,215
TKP91H80W500-MUGA	—	1,026
TKP91H80W500-FUGA	—	1,058
TKP91H80W500-MUCRGA	—	1,329
TKP91H80W500-FUCRGA	—	1,361
TKP91H80-ST5	—	20
TKP91H80-STL	—	20
TKP91H80-STE	—	17
TKP91H80-HS150	—	7
TKP91H80-HS175	—	8
TKP91H80-HS200	—	9
TKP91H80-EHS24	—	2
TKP91H80-EHS30	—	3
TKP91H80-EHS36	—	4
TKP91H80-EHS42	—	4
TKP91H80-EHS48	—	5
TKP91H80-EHS54	—	5
TKP91H80-EHS24.5	—	2
TKP91H80-EHS30.5	—	3
TKP91H80-EHS36.5	—	4
TKP91H80-EHS42.5	—	4
TKP91H80-EHS48.5	—	5
TKP91H80-EHS54.5	—	5
TKP91H80-EHS22	—	2
TKP91H80-EHS28	—	3
TKP91H80-EHS34	—	3
TKP91H80-EHS40	—	4
TKP91H80-EHS46	—	4
TKP91H80-EHS52	—	5
TKP91H80-EHS22.5	—	2
TKP91H80-EHS28.5	—	3
TKP91H80-EHS34.5	—	3
TKP91H80-EHS40.5	—	4
TKP91H80-EHS46.5	—	4
TKP91H80-EHS52.5	—	5
TKP91H80-EHS23	—	2
TKP91H80-EHS29	—	3
TKP91H80-EHS35	—	4
TKP91H80-EHS41	—	4
TKP91H80-EHS47	—	5
TKP91H80-EHS53	—	5
TKP91H80-EHS23.5	—	2
TKP91H80-EHS29.5	—	3
TKP91H80-EHS35.5	—	4
TKP91H80-EHS41.5	—	4
TKP91H80-EHS47.5	—	5
TKP91H80-EHS53.5	—	5
TKP125H74W150R■	4.5	—
TKP125H74W250R■	5.1	—
TKP125H74W350R■	5.7	—
TKP125H74-MOA	—	966
TKP125H74-MIA	—	966
TKP125H74-FOA	—	864
TKP125H74-FIA	—	864
TKP125H74-MOAGA	—	925
TKP125H74-MIAGA	—	925
TKP125H74-ST	—	15
TKP125H74-HS150	—	12
TKP125H74-HS250	—	16

**TKP Series, MW Type**

Model number/ product name	Mass (kg/m)	Mass (g/each)
TKP13H10-30W10R■ ■ ■ M	0.2	—
TKP13H10-30W20R■ ■ ■ M	0.2	—
TKP13H10W10M-MO	—	2
TKP13H10W10M-MI	—	—
TKP13H10W10M-FO	—	2
TKP13H10W10M-FI	—	—
TKP13H10W20M-MO	—	3
TKP13H10W20M-MI	—	—
TKP13H10W20M-FO	—	3
TKP13H10W20M-FI	—	—
TKP18H14-30W15R■ ■ ■ M	0.3	—
TKP18H14-30W40R■ ■ ■ M	0.3	—
TKP18H14W15M-MO	—	7
TKP18H14W15M-MI	—	—
TKP18H14W15M-FO	—	7
TKP18H14W15M-FI	—	—
TKP18H14W40M-MO	—	10
TKP18H14W40M-MI	—	—
TKP18H14W40M-FO	—	10
TKP18H14W40M-FI	—	—
TKP25H15-30W15R■ ■ ■ M	0.3	—
TKP25H15-30W20R■ ■ ■ M	0.3	—
TKP25H15-30W30R■ ■ ■ M	0.3	—
TKP25H15W15M-MO	—	6
TKP25H15W15M-MI	—	—
TKP25H15W15M-FO	—	6
TKP25H15W15M-FI	—	—
TKP25H15W20M-MO	—	15
TKP25H15W20M-MI	—	—
TKP25H15W20M-FO	—	15
TKP25H15W20M-FI	—	—
TKP25H15W30M-MO	—	8
TKP25H15W30M-MI	—	—
TKP25H15W30M-FO	—	7
TKP25H15W30M-FI	—	—
TKP35H22-30W13R■ ■ ■ M	0.4	—
TKP35H22-40W13R■ ■ ■ M	—	—
TKP35H22-30W25R■ ■ ■ M	0.4	—
TKP35H22-40W25R■ ■ ■ M	—	—
TKP35H22-30W38R■ ■ ■ M	0.5	—
TKP35H22-40W38R■ ■ ■ M	—	—
TKP35H22-30W50R■ ■ ■ M	0.6	—
TKP35H22-40W50R■ ■ ■ M	—	—
TKP35H22-30W63R■ ■ ■ M	0.7	—
TKP35H22-40W63R■ ■ ■ M	—	—
TKP35H22W13M-MO	—	13
TKP35H22W13M-MI	—	—
TKP35H22W13M-FO	—	13
TKP35H22W13M-FI	—	—
TKP35H22W25M-MO	—	15
TKP35H22W25M-MI	—	—
TKP35H22W25M-FO	—	15
TKP35H22W25M-FI	—	—
TKP35H22W38M-MO	—	18
TKP35H22W38M-MI	—	—
TKP35H22W38M-FO	—	18
TKP35H22W38M-FI	—	—
TKP35H22W50M-MO	—	20
TKP35H22W50M-MI	—	—
TKP35H22W50M-FO	—	20
TKP35H22W50M-FI	—	—
TKP35H22W63M-MO	—	24
TKP35H22W63M-MI	—	—
TKP35H22W63M-FO	—	24
TKP35H22W63M-FI	—	—
TKP35H22M-ST	—	2
TKP35H22M-HS38	—	3
TKP35H22M-HS50	—	3
TKP35H22M-HS63	—	4
TKP35H32-30W16R■ ■ ■ M	0.2	—
TKP35H32W16M-MO	—	18
TKP35H32W16M-MI	—	—
TKP35H32W16M-FO	—	14

Model number/ product name	Mass (kg/m)	Mass (g/each)
TKP45H25-30W38R■ ■ ■ M	—	—
TKP45H25-40W38R■ ■ ■ M	0.9	—
TKP45H25-30W58R■ ■ ■ M	—	—
TKP45H25-40W58R■ ■ ■ M	1.1	—
TKP45H25-30W78R■ ■ ■ M	—	—
TKP45H25-40W78R■ ■ ■ M	1.3	—
TKP45H25-30W103R■ ■ ■ M	—	—
TKP45H25-40W103R■ ■ ■ M	1.5	—
TKP45H25-MOA	—	—
TKP45H25-MIA	—	82
TKP45H25-MOB	—	—
TKP45H25-MIB	—	—
TKP45H25-MC	—	76
TKP45H25-FOA	—	—
TKP45H25-FIA	—	68
TKP45H25-FOB	—	—
TKP45H25-FIB	—	—
TKP45H25-FC	—	54
TKP45H25M-ST	—	2
TKP45H25M-HS38	—	3
TKP45H25M-HS58	—	4
TKP45H25M-HS78	—	6
TKP45H25M-HS103	—	8

# Table of Product Masses

## TKR Series

Model number/product name	Mass (kg/m)	Mass (g/each)
TKR15H22-30W20R■	0.3	—
TKR15H22-30W20R■ ETL		—
TKR15H22-30W40R■	0.4	—
TKR15H22-30W40R■ ETL		—
TKR15H22-30W60R■	0.5	—
TKR15H22-30W60R■ ETL		—
TKR15H22W20-MO	—	11
TKR15H22W20-MI	—	11
TKR15H22W20-FO	—	11
TKR15H22W20-FI	—	11
TKR15H22W40-MO	—	12
TKR15H22W40-MI	—	12
TKR15H22W40-FO	—	12
TKR15H22W40-FI	—	12
TKR15H22W60-MO	—	14
TKR15H22W60-MI	—	14
TKR15H22W60-FO	—	14
TKR15H22W60-FI	—	14
TKR15H22-ST	—	1
TKR15H22-HS20	—	1
TKR15H22-HS40	—	2
TKR15H22-HS60	—	3
TKR20H28W30R■	0.7	—
TKR20H28W40R■	0.7	—
TKR20H28W50R■	0.8	—
TKR20H28W60R■	0.8	—
TKR20H28W80R■	0.9	—
TKR20H28W100R■	1.0	—
TKR20H28W120R■	1.1	—
TKR20H28W30-MU	—	36
TKR20H28W30-MO	—	34
TKR20H28W30-MI	—	34
TKR20H28W30-FU	—	37
TKR20H28W30-FO	—	35
TKR20H28W30-FI	—	35
TKR20H28W40-MU	—	36
TKR20H28W40-MO	—	34
TKR20H28W40-MI	—	34
TKR20H28W40-FU	—	38
TKR20H28W40-FO	—	36
TKR20H28W40-FI	—	36
TKR20H28W50-MU	—	37
TKR20H28W50-MO	—	35
TKR20H28W50-MI	—	35
TKR20H28W50-FU	—	38
TKR20H28W50-FO	—	36
TKR20H28W50-FI	—	36
TKR20H28W60-MU	—	37
TKR20H28W60-MO	—	35
TKR20H28W60-MI	—	35
TKR20H28W60-FU	—	39
TKR20H28W60-FO	—	37
TKR20H28W60-FI	—	37
TKR20H28W80-MU	—	38
TKR20H28W80-MO	—	36
TKR20H28W80-MI	—	36
TKR20H28W80-FU	—	40
TKR20H28W80-FO	—	38
TKR20H28W80-FI	—	38
TKR20H28W100-MU	—	39
TKR20H28W100-MO	—	37
TKR20H28W100-MI	—	37
TKR20H28W100-FU	—	41
TKR20H28W100-FO	—	39
TKR20H28W100-FI	—	39
TKR20H28W120-MU	—	39
TKR20H28W120-MO	—	37
TKR20H28W120-MI	—	37
TKR20H28W120-FU	—	41
TKR20H28W120-FO	—	39
TKR20H28W120-FI	—	39
TKR20H28-STAS	—	1
TKR20H28-STAL	—	1
TKR20H28-HS30	—	2
TKR20H28-HS40	—	2
TKR20H28-HS50	—	3
TKR20H28-HS60	—	4
TKR20H28-HS80	—	4
TKR20H28-HS100	—	5
TKR20H28-HS120	—	5

Model number/product name	Mass (kg/m)	Mass (g/each)
TKR26H40W50R■	1.5	—
TKR26H40W62R■	1.6	—
TKR26H40W75R■	1.7	—
TKR26H40W87R■	1.8	—
TKR26H40W100R■	1.9	—
TKR26H40W125R■	2.1	—
TKR26H40W150R■	2.3	—
TKR26H40W200R■	2.7	—
TKR26H40W50-MU	—	65
TKR26H40W50-FU	—	61
TKR26H40W50-MUCL	—	74
TKR26H40W50-FUCL	—	70
TKR26H40W50-MUCR	—	92
TKR26H40W50-FUCR	—	88
TKR26H40W62-MU	—	69
TKR26H40W62-FU	—	65
TKR26H40W62-MUCR	—	103
TKR26H40W62-FUCR	—	99
TKR26H40W75-MU	—	71
TKR26H40W75-FU	—	67
TKR26H40W75-MUCL	—	84
TKR26H40W75-FUCL	—	80
TKR26H40W75-MUCR	—	111
TKR26H40W75-FUCR	—	107
TKR26H40W87-MU	—	74
TKR26H40W87-FU	—	70
TKR26H40W87-MUCR	—	118
TKR26H40W87-FUCR	—	114
TKR26H40W100-MU	—	77
TKR26H40W100-FU	—	73
TKR26H40W100-MUCL	—	94
TKR26H40W100-FUCL	—	90
TKR26H40W100-MUCR	—	130
TKR26H40W100-FUCR	—	126
TKR26H40W125-MU	—	83
TKR26H40W125-FU	—	79
TKR26H40W125-MUCL	—	104
TKR26H40W125-FUCL	—	100
TKR26H40W125-MUCR	—	148
TKR26H40W125-FUCR	—	144
TKR26H40W150-MU	—	88
TKR26H40W150-FU	—	84
TKR26H40W150-MUCL	—	113
TKR26H40W150-FUCL	—	109
TKR26H40W150-MUCR	—	166
TKR26H40W150-FUCR	—	162
TKR26H40W200-MU	—	100
TKR26H40W200-FU	—	90
TKR26H40W200-MUCR	—	189
TKR26H40W200-FUCR	—	190
TKR26H40-STAS	—	3
TKR26H40-STAL	—	3
TKR26H40-STBS	—	5
TKR26H40-STBL	—	5
TKR26H40-HS50	—	3
TKR26H40-HS62	—	4
TKR26H40-HS75	—	5
TKR26H40-HS87	—	6
TKR26H40-HS100	—	7
TKR26H40-HS125	—	9
TKR26H40-HS150	—	11
TKR26H40-HS200	—	15
TKR26H40W50-CL-U	—	9
TKR26H40W50-CRA	—	27
TKR26H40W62-CRA	—	33
TKR26H40W75-CL-U	—	13
TKR26H40W75-CRA	—	40
TKR26H40W87-CRA	—	47
TKR26H40W100-CL-U	—	17
TKR26H40W100-CRA	—	53
TKR26H40W125-CL-U	—	21
TKR26H40W125-CRA	—	65
TKR26H40W150-CL-U	—	25
TKR26H40W150-CRA	—	78
TKR26H40W200-CRA	—	104

Model number/product name	Mass (kg/m)	Mass (g/each)
TKR28H52W50R■	2.0	—
TKR28H52W62R■	2.1	—
TKR28H52W75R■	2.2	—
TKR28H52W87R■	2.3	—
TKR28H52W100R■	2.4	—
TKR28H52W125R■	2.6	—
TKR28H52W150R■	2.8	—
TKR28H52W200R■	3.2	—
TKR28H52W50-MU	—	88
TKR28H52W50-FU	—	84
TKR28H52W50-MUCL	—	97
TKR28H52W50-FUCL	—	93
TKR28H52W50-MUCR	—	115
TKR28H52W50-FUCR	—	111
TKR28H52W62-MU	—	92
TKR28H52W62-FU	—	87
TKR28H52W62-MUCR	—	126
TKR28H52W62-FUCR	—	121
TKR28H52W75-MU	—	94
TKR28H52W75-FU	—	90
TKR28H52W75-MUCL	—	107
TKR28H52W75-FUCL	—	103
TKR28H52W75-MUCR	—	134
TKR28H52W75-FUCR	—	130
TKR28H52W87-MU	—	97
TKR28H52W87-FU	—	93
TKR28H52W87-MUCR	—	141
TKR28H52W87-FUCR	—	137
TKR28H52W100-MU	—	100
TKR28H52W100-FU	—	96
TKR28H52W100-MUCL	—	117
TKR28H52W100-FUCL	—	113
TKR28H52W100-MUCR	—	153
TKR28H52W100-FUCR	—	149
TKR28H52W125-MU	—	106
TKR28H52W125-FU	—	102
TKR28H52W125-MUCL	—	127
TKR28H52W125-FUCL	—	123
TKR28H52W125-MUCR	—	171
TKR28H52W125-FUCR	—	167
TKR28H52W150-MU	—	111
TKR28H52W150-FU	—	107
TKR28H52W150-MUCL	—	136
TKR28H52W150-FUCL	—	132
TKR28H52W150-MUCR	—	189
TKR28H52W150-FUCR	—	185
TKR28H52W200-MU	—	135
TKR28H52W200-FU	—	119
TKR28H52W200-MUCR	—	239
TKR28H52W200-FUCR	—	223
TKR28H52-STAS	—	4
TKR28H52-STAL	—	4
TKR28H52-STBS	—	7
TKR28H52-STBL	—	7
TKR28H52-HS50	—	3
TKR28H52-HS62	—	4
TKR28H52-HS75	—	5
TKR28H52-HS87	—	6
TKR28H52-HS100	—	7
TKR28H52-HS125	—	9
TKR28H52-HS150	—	11
TKR28H52-HS200	—	15
TKR28H52W50-CL-U	—	9
TKR28H52W50-CRA	—	27
TKR28H52W62-CRA	—	34
TKR28H52W75-CL-U	—	13
TKR28H52W75-CRA	—	40
TKR28H52W87-CRA	—	47
TKR28H52W100-CL-U	—	17
TKR28H52W100-CRA	—	53
TKR28H52W125-CL-U	—	21
TKR28H52W125-CRA	—	65
TKR28H52W150-CL-U	—	25
TKR28H52W150-CRA	—	78
TKR28H52W200-CRA	—	104

## TKR Series

Model number/product name	Mass (kg/m)	Mass (g/each)
TKR37H28W40R■	0.53	—
TKR37H28W50R■	0.55	—
TKR37H28W60R■	0.57	—
TKR37H28W70R■	0.59	—
TKR37H28W80R■	0.61	—
TKR37H28W40-MU	—	21
TKR37H28W40-FU	—	21
TKR37H28W40-MUCLO	—	25
TKR37H28W40-MUCLI	—	25
TKR37H28W40-MUCLB	—	30
TKR37H28W40-FUCLO	—	25
TKR37H28W40-FUCLI	—	25
TKR37H28W40-FUCLB	—	30
TKR37H28W50-MU	—	21
TKR37H28W50-FU	—	21
TKR37H28W50-MUCLO	—	27
TKR37H28W50-MUCLI	—	27
TKR37H28W50-MUCLB	—	33
TKR37H28W50-FUCLO	—	27
TKR37H28W50-FUCLI	—	27
TKR37H28W50-FUCLB	—	33
TKR37H28W60-MU	—	22
TKR37H28W60-FU	—	22
TKR37H28W60-MUCLO	—	29
TKR37H28W60-MUCLI	—	29
TKR37H28W60-MUCLB	—	36
TKR37H28W60-FUCLO	—	29
TKR37H28W60-FUCLI	—	29
TKR37H28W60-FUCLB	—	36
TKR37H28W70-MU	—	23
TKR37H28W70-FU	—	23
TKR37H28W70-MUCLO	—	31
TKR37H28W70-MUCLI	—	31
TKR37H28W70-MUCLB	—	40
TKR37H28W70-FUCLO	—	31
TKR37H28W70-FUCLI	—	31
TKR37H28W70-FUCLB	—	40
TKR37H28W80-MU	—	23
TKR37H28W80-FU	—	23
TKR37H28W80-MUCLO	—	33
TKR37H28W80-MUCLI	—	33
TKR37H28W80-MUCLB	—	43
TKR37H28W80-FUCLO	—	33
TKR37H28W80-FUCLI	—	33
TKR37H28W80-FUCLB	—	43
TKR37H28-STAS	—	1
TKR37H28-STAL	—	1
TKR37H28-HS40	—	2
TKR37H28-HS50	—	3
TKR37H28-HS60	—	3
TKR37H28-HS70	—	4
TKR37H28-HS80	—	4
TKR37H28W40-CL-U	—	5
TKR37H28W50-CL-U	—	6
TKR37H28W60-CL-U	—	7
TKR37H28W70-CL-U	—	9
TKR37H28W80-CL-U	—	10

## TKZP Series

Model number/product name	Mass (kg/m)	Mass (g/each)
TKZP10H13-40W10	0.06	—
TKZP10H13-40W15	0.07	—
TKZP10H13-40W20	0.08	—
TKZP10H13-40W25	0.09	—
TKZP10H13W10-MO	—	3
TKZP10H13W10-MI	—	3
TKZP10H13W10-FO	—	3
TKZP10H13W10-FI	—	3
TKZP10H13W15-MO	—	4
TKZP10H13W15-MI	—	4
TKZP10H13W15-FO	—	4
TKZP10H13W15-FI	—	4
TKZP10H13W20-MO	—	4
TKZP10H13W20-MI	—	4
TKZP10H13W20-FO	—	4
TKZP10H13W20-FI	—	4
TKZP10H13W25-MO	—	5
TKZP10H13W25-MI	—	5
TKZP10H13W25-FO	—	5
TKZP10H13W25-FI	—	5

# Table of Product Masses

## TKC Series

Model number/product name	Mass (kg/m)	Mass (g/each)
TKC28H30-30W28R	0.8	—
TKC28H30-30W48R	0.9	—
TKC28H30W28-MO	—	16
TKC28H30W28-FO	—	—
TKC28H30W28-FI	—	16
TKC28H30W48-MO	—	20
TKC28H30W48-FO	—	—
TKC28H30W48-FI	—	20
TKC28H30-ST	—	1
TKC28H30-HS48	—	4
TKC34H25W50R	1.5	—
TKC34H25W90R	1.9	—
TKC34H25W130R	2.1	—
TKC34H25-MOA	—	—
TKC34H25-MIA	—	113
TKC34H25-MC	—	90
TKC34H25-FOA	—	—
TKC34H25-FIA	—	83
TKC34H25-FC	—	138
TKC34H25-MOAGA	—	—
TKC34H25-MIAGA	—	112
TKC34H25-MCGA	—	91
TKC34H25W50-MD	—	196
TKC34H25W50-FD	—	186
TKC34H25W90-MD	—	220
TKC34H25W90-FD	—	210
TKC34H25W130-MD	—	268
TKC34H25W130-FD	—	258
TKC34H25-ST	—	2
TKC47H36W80R	2.5	—
TKC47H36W160R	3.5	—
TKC47H36-MOA	—	—
TKC47H36-MIA	—	202
TKC47H36-MC	—	180
TKC47H36-FOA	—	—
TKC47H36-FIA	—	142
TKC47H36-FC	—	138
TKC47H36-MOAGA	—	—
TKC47H36-MIAGA	—	208
TKC47H36-MCGA	—	176
TKC47H36W80-MD	—	406
TKC47H36W80-FD	—	364
TKC47H36W130-MD	—	522
TKC47H36W130-FD	—	480
TKC47H36-ST	—	3
TKC64H50W110R	4.0	—
TKC64H50W220R	5.0	—
TKC64H50-MOA	—	—
TKC64H50-MIA	—	388
TKC64H50-MC	—	320
TKC64H50-FOA	—	—
TKC64H50-FIA	—	264
TKC64H50-FC	—	234
TKC64H50-MOAGA	—	—
TKC64H50-MIAGA	—	397
TKC64H50-MCGA	—	333
TKC64H50W110-MD	—	716
TKC64H50W110-FD	—	716
TKC64H50W220-MD	—	816
TKC64H50W220-FD	—	816
TKC64H50-ST	—	8
TKC64H50-HS110	—	9
TKC64H50-HS220	—	18
TKC85H68W150R	5.7	—
TKC85H68W200R	6.5	—
TKC85H68W300R	8.0	—
TKC85H68W350R	9.0	—
TKC85H68-MOA	—	966
TKC85H68-MIA	—	—
TKC85H68-MC	—	786
TKC85H68-FOA	—	—
TKC85H68-FIA	—	636
TKC85H68-FC	—	560
TKC85H68-MOAGA	—	—
TKC85H68-MIAGA	—	944
TKC85H68-MCGA	—	795
TKC85H68W150-MD	—	1,754
TKC85H68W150-FD	—	1,528
TKC85H68W200-MD	—	1,922
TKC85H68W200-FD	—	1,696
TKC85H68W300-MD	—	2,272
TKC85H68W300-FD	—	2,046
TKC85H68-ST	—	10
TKC85H68-HS150	—	12
TKC85H68-HS200	—	16

Model number/product name	Mass (kg/m)	Mass (g/each)
TKC91H56W150R	5.4	—
TKC91H56W200R	6.2	—
TKC91H56W250R	7.0	—
TKC91H56W300R	7.7	—
TKC91H56W350R	8.5	—
TKC91H56W400R	9.2	—
TKC91H56W150R-GA	5.8	—
TKC91H56W200R-GA	6.5	—
TKC91H56W250R-GA	7.3	—
TKC91H56W300R-GA	8.0	—
TKC91H56W350R-GA	8.8	—
TKC91H56W400R-GA	9.6	—
TKC91H56W150-MU	—	598
TKC91H56W150-FU	—	560
TKC91H56W150-MUCR	—	691
TKC91H56W150-FUCR	—	653
TKC91H56W150-MUGA	—	598
TKC91H56W150-FUGA	—	592
TKC91H56W150-MUCRGA	—	691
TKC91H56W150-FUCRGA	—	685
TKC91H56W200-MU	—	666
TKC91H56W200-FU	—	628
TKC91H56W200-MUCR	—	789
TKC91H56W200-FUCR	—	751
TKC91H56W200-MUGA	—	666
TKC91H56W200-FUGA	—	660
TKC91H56W200-MUCRGA	—	789
TKC91H56W200-FUCRGA	—	783
TKC91H56W250-MU	—	736
TKC91H56W250-FU	—	698
TKC91H56W250-MUCR	—	889
TKC91H56W250-FUCR	—	851
TKC91H56W250-MUGA	—	736
TKC91H56W250-FUGA	—	730
TKC91H56W250-MUCRGA	—	889
TKC91H56W250-FUCRGA	—	883
TKC91H56W300-MU	—	804
TKC91H56W300-FU	—	766
TKC91H56W300-MUCR	—	987
TKC91H56W300-FUCR	—	949
TKC91H56W300-MUGA	—	804
TKC91H56W300-FUGA	—	798
TKC91H56W300-MUCRGA	—	987
TKC91H56W300-FUCRGA	—	981
TKC91H56W350-MU	—	874
TKC91H56W350-FU	—	836
TKC91H56W350-MUCR	—	1,087
TKC91H56W350-FUCR	—	1,049
TKC91H56W350-MUGA	—	874
TKC91H56W350-FUGA	—	868
TKC91H56W350-MUCRGA	—	1,087
TKC91H56W350-FUCRGA	—	1,081
TKC91H56W400-MU	—	942
TKC91H56W400-FU	—	904
TKC91H56W400-MUCR	—	1,185
TKC91H56W400-FUCR	—	1,147
TKC91H56W400-MUGA	—	942
TKC91H56W400-FUGA	—	936
TKC91H56W400-MUCRGA	—	1,185
TKC91H56W400-FUCRGA	—	1,179
TKC91H56-ST	—	15
TKC91H56-STL	—	15
TKC91H56-STE	—	12
TKC91H56-HS150	—	7
TKC91H56-HS200	—	9
TKC91H56-EHS24	—	2
TKC91H56-EHS30	—	3
TKC91H56-EHS36	—	4
TKC91H56-EHS42	—	4
TKC91H56-EHS48	—	5
TKC91H56-EHS54	—	5
TKC91H56-EHS22	—	2
TKC91H56-EHS28	—	3
TKC91H56-EHS34	—	3
TKC91H56-EHS40	—	4
TKC91H56-EHS46	—	4
TKC91H56-EHS52	—	5
TKC91H56-EHS23	—	2
TKC91H56-EHS29	—	3
TKC91H56-EHS35	—	4
TKC91H56-EHS41	—	4
TKC91H56-EHS47	—	5
TKC91H56-EHS53	—	5
TKC91H56-EHS21	—	2
TKC91H56-EHS27	—	3
TKC91H56-EHS33	—	3
TKC91H56-EHS39	—	4
TKC91H56-EHS45	—	4
TKC91H56-EHS51	—	5

Model number/product name	Mass (kg/m)	Mass (g/each)
TKC91H80W150R	7.8	—
TKC91H80W200R	8.6	—
TKC91H80W250R	9.3	—
TKC91H80W300R	10.1	—
TKC91H80W350R	10.8	—
TKC91H80W400R	11.6	—
TKC91H80W150R-GA	8.1	—
TKC91H80W200R-GA	8.9	—
TKC91H80W250R-GA	9.6	—
TKC91H80W300R-GA	10.4	—
TKC91H80W350R-GA	11.1	—
TKC91H80W400R-GA	11.9	—
TKC91H80W150-MU	—	900
TKC91H80W150-FU	—	900
TKC91H80W150-MUCR	—	993
TKC91H80W150-FUCR	—	993
TKC91H80W150-MUGA	—	900
TKC91H80W150-FUGA	—	932
TKC91H80W150-MUCRGA	—	993
TKC91H80W150-FUCRGA	—	1,025
TKC91H80W200-MU	—	968
TKC91H80W200-FU	—	968
TKC91H80W200-MUCR	—	1,091
TKC91H80W200-FUCR	—	1,091
TKC91H80W200-MUGA	—	968
TKC91H80W200-FUGA	—	1,000
TKC91H80W200-MUCRGA	—	1,091
TKC91H80W200-FUCRGA	—	1,123
TKC91H80W250-MU	—	1,038
TKC91H80W250-FU	—	1,038
TKC91H80W250-MUCR	—	1,191
TKC91H80W250-FUCR	—	1,191
TKC91H80W250-MUGA	—	1,038
TKC91H80W250-FUGA	—	1,070
TKC91H80W250-MUCRGA	—	1,191
TKC91H80W250-FUCRGA	—	1,223
TKC91H80W300-MU	—	1,106
TKC91H80W300-FU	—	1,106
TKC91H80W300-MUCR	—	1,289
TKC91H80W300-FUCR	—	1,289
TKC91H80W300-MUGA	—	1,106
TKC91H80W300-FUGA	—	1,138
TKC91H80W300-MUCRGA	—	1,289
TKC91H80W300-FUCRGA	—	1,321
TKC91H80W350-MU	—	1,176
TKC91H80W350-FU	—	1,176
TKC91H80W350-MUCR	—	1,389
TKC91H80W350-FUCR	—	1,389
TKC91H80W350-MUGA	—	1,176
TKC91H80W350-FUGA	—	1,208
TKC91H80W350-MUCRGA	—	1,389
TKC91H80W350-FUCRGA	—	1,421
TKC91H80W400-MU	—	1,244
TKC91H80W400-FU	—	1,244
TKC91H80W400-MUCR	—	1,487
TKC91H80W400-FUCR	—	1,487
TKC91H80W400-MUGA	—	1,244
TKC91H80W400-FUGA	—	1,276
TKC91H80W400-MUCRGA	—	1,487
TKC91H80W400-FUCRGA	—	1,519
TKC91H80-ST	—	20
TKC91H80-STL	—	20
TKC91H80-STE	—	17
TKC91H80-HS150	—	7
TKC91H80-HS200	—	9
TKC91H80-EHS24	—	2
TKC91H80-EHS30	—	3
TKC91H80-EHS36	—	4
TKC91H80-EHS42	—	4
TKC91H80-EHS48	—	5
TKC91H80-EHS54	—	5
TKC91H80-EHS22	—	2
TKC91H80-EHS28	—	3
TKC91H80-EHS34	—	3
TKC91H80-EHS40	—	4
TKC91H80-EHS46	—	4
TKC91H80-EHS52	—	5
TKC91H80-EHS23	—	2
TKC91H80-EHS29	—	3
TKC91H80-EHS35	—	4
TKC91H80-EHS41	—	4
TKC91H80-EHS47	—	5
TKC91H80-EHS53	—	5
TKC91H80-EHS21	—	2
TKC91H80-EHS27	—	3
TKC91H80-EHS33	—	3
TKC91H80-EHS39	—	4
TKC91H80-EHS45	—	4
TKC91H80-EHS51	—	5

## TK/TKH/TKS/TKF Series

Model number/product name	Mass (kg/m)	Mass (g/each)
TK070R ■■	6.0	—
TK070-MOA	—	400
TK070-MIA	—	
TK070-MOB	—	
TK070-MIB	—	
TK070-FOA	—	400
TK070-FIA	—	
TK070-FOB	—	
TK070-FIB	—	
TK095R ■■	8.0	—
TK095-MOA	—	716
TK095-MIA	—	
TK095-MOB	—	
TK095-MIB	—	
TK095-FOA	—	716
TK095-FIA	—	
TK095-FOB	—	
TK095-FIB	—	
TK130R ■■	17.0	—
TK180R ■■	21.0	—
TKH250R ■■	40.0	—
TKS070SP100R ■■	6.4	—
TKS070SP150R ■■	6.6	—
TKS070SP200R ■■	6.7	—
TKS070-MOA	—	400
TKS070-MIA	—	
TKS070-MOB	—	
TKS070-MIB	—	
TKS070-FOA	—	400
TKS070-FIA	—	
TKS070-FOB	—	
TKS070-FIB	—	
TKS070-ST	—	4.2
TKS095SP100R ■■	8.4	—
TKS095SP150R ■■	8.5	—
TKS095SP200R ■■	8.6	—
TKS095-MOA	—	716
TKS095-MIA	—	
TKS095-MOB	—	
TKS095-MIB	—	
TKS095-FOA	—	716
TKS095-FIA	—	
TKS095-FOB	—	
TKS095-FIB	—	
TKS095-ST	—	6.3
TKF055R ■■	1.4	—
TKF055-KGAO	—	63
TKF055-KGAI	—	49
TKF055-KGB	—	53
TKF055-KGC	—	—
TKF085R ■■	2.0	—
TKF085-KGAO	—	66
TKF085-KGAI	—	82
TKF085-KGB	—	93
TKF085-KGC	—	—
TKF115R ■■	3.0	—
TKF115-KGAO	—	121
TKF115-KGAI	—	155
TKF115-KGB	—	188
TKF115-KGC	—	—
TKF175R ■■	5.0	—
TKF175-KGAO	—	309
TKF175-KGAI	—	375
TKF175-KGB	—	452
TKF175-KGC	—	—

# Cable Carrier Selection

## Important Points to Consider Before Selecting a Cable Carrier

### Cables/hoses

#### 1. Cable/hose types

Use highly flexible cables/hoses for movement offering excellent flexibility, wear resistance, and continuous bending.

When using wire-braiding coated cables/hoses, the sliding of the cable will cause damage to both the cable carrier and the wire-braiding coated cables. Do not use such cables/hoses under any circumstances.

#### 2. Allowable cable/hose bending radius

The allowable bending radius of the cable/hose should be a value that applies when the cable/hose is movable (continuous bending).

Contact the cable/hose manufacturer for details.

Reference: Use the following as a guideline.

##### For cables

Allowable cable bending radius  $r \geq$  Outer diameter of cable  $\times 7.5^*$  (\*Varies depending on cable type)

##### For hoses

Allowable hose bending radius  $r \geq$  Outer diameter of hose  $\times 9^*$  (\*Varies depending on hose type)

This will need to be increased even further with more frequent use, high-rigidity cables/hoses, or hydraulic hoses.

### Cable carrier bending radius

The bending radius of the cable carrier should be larger than the allowable bending radius of the cable or hose.

Ensuring a cable carrier bending radius larger than the allowable bending radius of the cable or hose contributes to reduced wear of the cable or hose, allowing for a longer service life for the cable carrier. As such, be sure to select as large a bending radius as possible.

### Various environmental resistances of cable carriers

#### 1. Temperature

Refer to the individual product pages for the operating temperature ranges. However, note that the service life may be shortened depending on the operating conditions. In addition, the cable carrier may not bend smoothly in freezing in environments with low temperatures and high moisture. Forced operation under such conditions may damage the cable carrier. Be sure to remove any moisture from frozen sections before operating.

#### 2. Moisture and humidity

Cable carriers can be used under normal atmospheric conditions (including outdoor environments). However, if the system will be exposed to environments with high humidity or high moisture content, or exposed to the elements, it is recommended that steel components be made of stainless steel.

#### 3. Outdoor installation (effects of UV rays)

Cable carriers can be used in outdoor environments. However, Cable Carrier Plastic Series products will undergo increased deterioration, resulting in a shortened service life under some operating conditions.

#### 4. Chemical resistance of cable carriers to various solvents

When selecting a cable carrier, check if the chemical resistance of the materials in the below table are sufficient. This table shows the approximate material characteristics at 20°C, but the information in this table is not guaranteed. Conduct a overall review of the temperature, humidity, and operating conditions for actual usage.

○: Sufficient chemical resistance, △: Chemical resistance under some operating conditions, x: No chemical resistance, -: Unknown

Solvent		Materials																													
		Acetone	Oil (plant-based/mineral-based)	Alcohol	Ammonia	Calcium chloride aqueous solution	Sodium chloride	Hydrochloric acid (2%)	Seawater	Hydrogen peroxide	Sodium hydroxide (10%)	Formic acid (10%)	Citric acid (10%)	Chromic acid (1%)	Acetic acid (5%)	Carbon tetrachloride	Sodium hypochlorite (10%)	Nitric acid (5%)	Lubrication oil	Potassium hydroxide	Soapy water	Petroleum	Diesel fuel	Toluene	Paraffin	Benzene	Iodine	Vitriol oil	Phosphoric acid (10%)	Petroleum jelly	
Steel		△	○	○	△	x	x	x	x	x	x	x	x	x	x	△	x	x	○	△	△	○	○	○	○	○	○	x	x	x	○
Stainless steel		○	○	○	○	△	○	x	△	○	○	○	○	○	○	○	x	○	○	○	○	○	○	○	○	○	○	x	x	△	○
Engineering plastic	Standard products other than those listed below	○	○	○	○	○	x	○	x	○	△	○	x	○	○	x	x	○	○	○	○	○	○	○	○	○	x	x	x	○	
	TKP-MW Type/TKR Series	○	○	○	○	—	○	x	△	x	○	x	△	x	○	○	x	x	—	○	—	—	—	○	○	x	x	x	—	—	
	TKZP Series	△	△	○	△	△	○	△	△	△	○	x	x	—	x	△	△	△	△	△	○	△	x	x	△	—	x	x	△	—	—

Note: Engineering plastic refers to the engineering plastics used in our cable carriers.

### Cable Carrier Plastic Series flame resistance standard

The Tsubaki Cable Carrier Plastic Series uses **UL standard: UL 94HB** class plastics based on the Underwriters Laboratories standard for the flame-resistant safety inspection of plastic products.



## Selection of Cable Carrier Plastic Series

This selection is applicable to the TKP Series, TKC Series, and TKR Series.

### Step 1: Check operating environment

Check whether temperature, humidity, water and chemicals can be used.

Classification and features: Page 11  
Environmental resistance, chemical resistance: Page 151, each product page

### Step 2: Check operating conditions

Check the operating conditions required for cable carrier selection.

Item: 1. Travel length      2. Travel speed, acceleration  
3. Additional load      4. Outer diameter and number of cables/hoses  
5. Installation method   6. Operating environment  
Each product page, pages 11 and 156

### Step 3: Study installation method (arrangement)

Check the features for each installation method to determine the installation method.

Installation instructions: Page 123

### Step 4: Study installation of cables and hoses

Consider cable/hose installation (placement).

Determine model by cable/hose installing space: Page 153

### Step 5: Determine the bending radius

Determine the bending radius to determine the model.

Cable/hose bending radius: Page 156  
See detailed dimensions and notes on the pages for each model.

### Step 6: Determine the model of cable carriers according to the capability

Check whether the travel length and additional load are within capability range.

Load diagram: Each product page  
Installation instructions: Page 123

### Step 7: Determine number of links

Calculate the required number of links.

Calculating number of links: Each product page

### Step 8: Study mounting method

Consider the mounting and installation dimensions, and guide method.

Installation and maintenance: Page 157

### Step 9: Ordering

Check the ordering information.

Detail on the model number and ordering information:  
Pages 17–19

## Precautions when selecting Cable Carrier Plastic Series

### When the travel length is long

Review a cable carrier with the following specifications when the travel length exceeds the allowable value on the load diagram.

- ◆ Gliding arrangement  
Suitable for extremely long lengths. .... Page 127
- ◆ Side mount arrangement  
Suitable for use a low speeds (60 m/min or less). ... Page 125
- ◆ Support roller arrangement  
Use the load diagram. .... Page 123
- ◆ With support plates  
Applicable to the TKC Series. Use the load diagram. ... Page 123

Note: The Cable Carrier Steel Series allows for longer travel lengths in the standard arrangement than the Cable Carrier Plastic Series.

### When the cable/hose mass is large

Review the following when the cable/hose mass is larger than the load diagram.

- ◆ Nested arrangement  
Applicable to the TKP Series and TKC Series. .... Page 126  
(Not applicable to the TKR Series.)
- ◆ Split into multiple cable carriers.

### When the amount of space to install cables and hoses is low

- ◆ Increase the size of the cable carrier.
- ◆ Split into multiple cable carriers.

### High frequency/low noise

- ◆ Select the TKR Series or Tsubaki Kabelschlepp Quantum Series when high speeds, high acceleration, high frequencies, and low noise are required. Contact a Tsubaki representative for further information. .... Page 67

### Low debris generation

To lessen the amount of debris generated from the cable carrier, select the TKR Series or TKP Series MW Type. ... Pages 65 and 67

### Atmosphere

Consider the following special types when using the cable carrier in a special operating environment.

- ◆ Chemical-resistant type  
The TKP Series and TKC Series can be manufactured using materials with superior chemical resistance.
- ◆ Antistatic type  
The TKP Series and TKC Series can be manufactured using materials with superior electrical conductivity.  
Contact a Tsubaki representative when considering cable carriers with the above types.

### When a lateral load is applied

Install guides to prevent collapse when lateral loads are applied such as during ceiling crane running.

### When exposed to vibrations

Take care to prevent vibrations from the machine being transmitted to the cable carrier if external vibrations from manipulators, rock drills, or other equipment are a concern.

# Cable Carrier Selection

## Determine cable carrier model by cable/hose installing space (TKP Series/TKC Series/TKR Series/TKF Series)

The cable/hose installing section is determined by checking the space of the cross section based on the outer diameter/number of cables and hoses.

- Determine the inner height
 

Check the inner height of the cable carrier by the maximum outer diameter of cables and hoses. (See pages 11, 13, and 136.)
---
- Determine the inner width
 

Check the inner width of the cable carrier by the outer diameter/number of cables and hoses. Cable carrier inner width $\geq \Sigma$ (outer diameter $\times$ 1.1) + Divider thickness $\times$ Number of dividers Note: The installation dimensions of dividers depend on whether they slide or lock.
--

### Reference: Correct arrangement for cables and hoses

**Recommended**  
2 mm or more  
2 mm or more  
D  
H  
W  
 $\{ W = D \times 1.1 \text{ or more}$   
 $\{ H = D \times 1.1 \text{ or more}$

**Allowable**

**Not recommended**  
Cables/hoses are in contact with each other.

**Not recommended**  
★Smaller cables/hoses tend to become damaged.  
★Larger cables/hoses may ride up on thinner cables/hoses.

**Not recommended**  
★Larger cables/hoses may ride up on thinner cables/hoses.

**Allowable**  
Sufficient space vertically is necessary.

**Not recommended**

#### Notes on arrangement

- Provide clearance between the outer diameter and the inner width of the cable/hose.
- Lay out the cables/hoses in a row horizontally.
- Do not arrange the cables/hoses in a way that causes them to interfere with each other.
- Do not use so many cables/hoses that excessive force is applied to the cable/hose.
- Use dividers for series that allow for the use of dividers. Use a divider that allows only one cable/hose to be used in any one compartment.

## Dividers

Dividers are important parts that protect cables and hoses. Separate cables and hoses and install them into the cable carrier by using dividers when possible.

### Function of dividers:

- To prevent cables and hoses from sliding against each other
- To prevent cables and hoses twisting and becoming kinked
- To reduce noise for signal wires

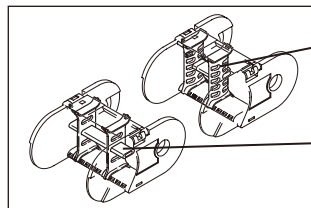

**Vertical divider:** Divides the inner width of the internal cross section of the cable carrier. (Not available for the TKP13H10, TKP17H11, TKP18H14, TKP18H15, or TKP25H15.)

**Horizontal divider:** Divides the internal height of the internal cross section of the cable carrier.

### Vertical divider

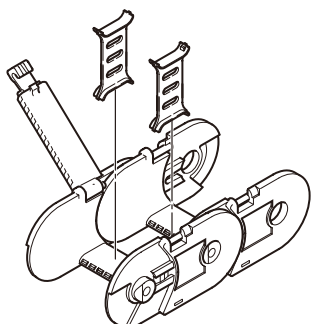

- Material: Engineering plastic
- There is a type that can slide in the horizontal direction and a type that can be fixed. (Refer to the pages that list the models.)
- Normally installed every 2 links.
- Normally delivered uninstalled.
- Case for fixing vertical dividers: Dividers may move when cables and hoses move violently. This may cause damage to the cables and hoses.
- For the side mount and horizontal circular travel arrangements with sliding divider types, the dividers may move down due to the weight of the cables and hoses and cause damage to the cables and hoses.

\* For the TKP45H25 and TKP58H39, fixed spacers are offered as an option. Contact a Tsubaki representative for further information.

### Horizontal divider

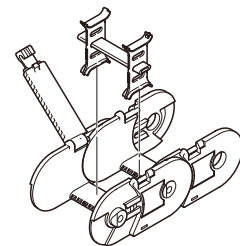

- Material: Engineering plastic or aluminum
- Installed on vertical dividers.

#### \* 2 or more vertical dividers are required.

- The installation method depends on the shape of the vertical dividers.
- Normally installed every 2 links.
- Normally delivered uninstalled.

## Selection of Cable Carrier Steel Series

This selection is applicable to the TK Series, TKS Series, and TKH Series.

### Step 1: Check operating environment

Check whether temperature, humidity, water and chemicals can be used.

Classification and features: Page 13  
Environmental resistance, chemical resistance: Page 151, each product page

### Step 2: Check operating conditions

Check the operating conditions required for cable carrier selection.

Items: 1. Travel length                      2. Travel speed, acceleration  
3. Additional load                      4. Outer diameter and number of cables/hoses  
5. Installation method                      6. Operating environment  
Pages 13 and 156

### Step 3: Study installation method (arrangement)

Check the features for each installation method to determine the installation method.

Installation instructions: Page 123

### Step 4: Determine the model of cable carriers according to the capability

Determine the model according to the load diagram.

Load diagram: Each product page  
Installation instructions: Page 123

### Step 5: Study installation of cables and hoses

Consider cable/hose installation (placement).

Determine model by cable/hose installing space: Page 155

### Step 6: Determine number of links

Calculate the required number of links.

Calculating number of links: Each product page

### Step 7: Study mounting method

Consider the mounting and installation dimensions, and guide method.

Installation and maintenance: Page 157

### Step 8: Ordering

Check the ordering information.

Detail on the model number and ordering information: Page 20

## Precautions when selecting Cable Carrier Steel Series products

#### When the travel length is long

Review a cable carrier with the following specifications when the travel length is longer than the load diagram.

- ◆ TKV Series/TKI Series  
Suitable for extremely long lengths. ....Pages 111 and 112
- ◆ Side mount arrangement  
Use the cable carrier by installing casters or shoes on the bottom of the chain. Applicable to the TK Series and TKH Series. ....Page 125
- ◆ Side roller type  
Install side rollers to the chain. Applicable to the TK Series. ....Page 126
- ◆ Support roller arrangement  
Applicable to the TK Series, TKS Series, and TKH Series. Use the load diagram. ....Page 123

#### When the cable/hose mass is large

Review the following when the cable/hose mass is larger than the load diagram.

- ◆ Nested arrangement  
Applicable to the TK Series and TKH Series. ....Page 126
- ◆ Multiple chain type  
Applicable to the TK Series, TKS Series, and TKH Series. ....Page 135
- ◆ TKV Series/TKI Series  
Suitable for high loads. ....Pages 111 and 112

#### When the amount of space to install cables and hoses is low

- ◆ Nested arrangement  
Applicable to the TK Series and TKH Series. ....Page 126
- ◆ Multiple chain type  
Applicable to the TK Series, TKS Series, and TKH Series. ....Page 135
- ◆ 3-partition split stay type  
Applicable to the TK Series and TKH Series.

#### High-frequency operation

Select the TKV Series and TKI Series for high-frequency operation. ....Pages 111 and 112

#### Atmosphere

When using the cable carrier in a special operating environment:

- ◆ For dusty environments  
Anti-dust series. ....Page 135
- ◆ For corrosive atmospheres (e.g., outdoor environments)  
Stainless steel type. ....Page 135

\* Contact a Tsubaki representative about selecting the TKV Series/TKI Series.

# Cable Carrier Selection

## Determine cable carrier model by cable/hose installing space (TK Series/TKH Series/TKS Series)

### TK Series/TKH Series

For the TK Series and TKH Series, the stay holes (D) are drilled to the specified dimensions.

- Calculate the minimum required width  $B'$  of the stay based on the outer diameter/number of cables and hoses, and select a stay with a stay width  $B \geq B'$ .

#### ◆ Stay dimensions

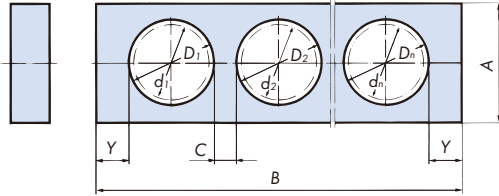

#### 1.1 Calculate stay bore diameter

$$D = d \times 1.1 \text{ Minimum clearance 2 mm}$$

$D$ : Stay bore diameter (  $\phi$  8 or larger integer value)  
 $d$ : Cable/hose outer diameter

#### 1.2 Calculate minimum required stay width

$$B' = Y + D_1 + C + D_2 + C + \dots + D_n + Y$$

$B'$ : Minimum required stay width  
 $C$ : 4 mm or larger  
 $Y$ : Table on the upper right

Note: Refer to the product pages for stay dimensions.

Model	Minimum value of Y	Model	Minimum value of Y
TK070	10	TK180	18
TK095	15	TKH250	25
TK130	18	-	-

#### 1.3 Select stay

Select dimensions  $A$  and  $B$  from the results calculated by 1.1 and 1.2 and the stay dimensions in the models (listed on the pages for models).

- Install the stays every 2 links starting from the second link on the moving end side.

$$\text{Number of stays (n)} = \frac{\text{Number of links (l)}}{2} \text{ Round down decimals}$$

#### Unsplit and split stays

The TK Series and TKH Series cable carriers have two types of stays: unsplit stays and split stays. Split stays have one end that can be easily removed so that supported materials can be easily added and removed. Split stays are convenient for when there are hoses with sleeves and the movement distance is long and also when there are many supported materials.

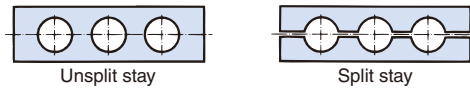

### TKS Series

#### ◆ Frame

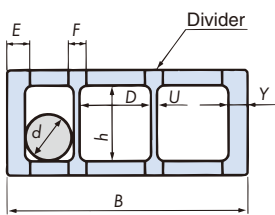

Decide the number of dividers by the minimum required or more and by ensuring that one cable or hose goes through one opening if possible. Lay out the cables and hoses by also taking into consideration the distribution of mass across the cable carrier.

- Calculate the minimum required width  $B'$  of the frame based on the outer diameter/number of cables and hoses, and select a frame with a stay width  $B \geq B'$ .

#### 1.1 Calculate the required inner width

$$D = d \times 1.1 \text{ Minimum clearance 2 mm}$$

$D$  : Required inner width (Round up decimals)  
 $d$  : Cable/hose outer diameter

#### 1.2 Calculate minimum required frame width

$$B' = \sum D + \sum U + 2Y$$

$B'$  : Minimum required frame width  
 $U$  : Divider thickness  
 $Y$  : Link thickness

#### 1.3 Select the frame

Select the frame from the results calculated by 1.1 and 1.2 and frame dimension  $B$  in the models (table on the upper right and listed on the pages for models).

- Number of frames and dividers

Install frames every 2 links.

$$\text{Number of frames (n)} = \frac{\text{Number of links (l)}}{2} \text{ Round down decimals}$$

Number of dividers ( $m$ ) =  $n \times$  (number of dividers installed in 1 location)

#### ■ Frame dimensions

Model	B (mm)	h (mm)	Y (mm)	U (mm)	E (mm)	F (mm)	Cable/hose maximum diameter d (mm)
TKS070	100	31	10	3	15	13	27
	150						
TKS095	200	46	12	4	17	14	42

#### ■ Minimum required number of dividers

Model	Minimum required number of dividers		
	B = 100 mm	B = 150 mm	B = 200 mm
TKS070	0 (5)	1 (8)	2 (12)
TKS095	0 (4)	1 (7)	2 (11)

Figure in ( ) is the maximum number installable.

## Bending radius R/strength selection

Select using the load diagram

1. The travel length  $S$  on the load diagram is applicable when the fixed end of the cable carrier is installed in the center position (middle) of the travel length.
2. Based on the models on the load diagram, select the strength from the travel length, cable/hose mass, cable/hose outer diameter, and cable/hose allowable bending radius.
3. Selection example: Selecting the TKC Series

Operating conditions  
 Travel length: 3 m  
 Cable/hose mass: 4 kg/m  
 Cable/hose outer diameter:  $\phi$  20 mm (x1)  
 Cable/hose allowable bending radius: 160 mm

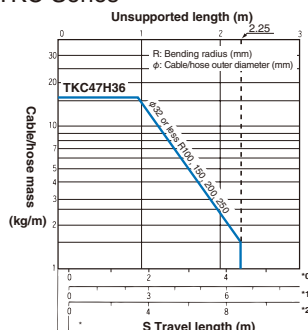

In the table to the left, find the intersection of horizontal axis 3 m and vertical axis 4 kg/m. Select the TKC47H36 as the product that satisfies this point.

Cable/hose allowable bending radius ( $r$ )

$\leq$

Cable carrier bending radius ( $R$ )

Decide on  $R = 200$  that satisfies these conditions.

Therefore,  
**TKC47H36W80R200** is the product from the above conditions.

## Confirm speed and acceleration

The allowable travel speeds for each model and installation method are shown below.

Confirm that the operating conditions do not exceed the allowable values. (Contact a Tsubaki representative if the allowable values are accidentally exceeded.)

### Table of allowable speeds

Unit: m/min

	TKP Series	TKC Series	TKR Series	TKF Series	TK Series	TKH Series	TKS Series	TKI Series	TKV Series
Standard	300	300	300	60	60	60	60	120	150
Support roller	150	150	150	—	60	60	60	—	—
Support plate	—	60	—	—	—	—	—	—	—
Horizontal	60	60	—	60	30	30	30	—	—
Vertical arrangement (hanging)	300	300	300	60	60	60	—	—	—
Vertical arrangement (standing)	300	300	—	60	60	60	—	—	—
Bottom movement	300	300	300	60	60	60	60	—	—
Combination	300	300	300	60	60	60	60	—	—
Gliding arrangement	★	★	—	—	—	—	—	—	—
Traveling roller	—	—	—	—	30	—	—	—	—
Horizontal rotation	30	30	—	—	30	—	—	—	—
Vertical rotation	60	—	—	—	60	—	—	—	—

★: Refer to page 129 for the gliding arrangement. — means not applicable.

### Table of allowable acceleration

If acceleration is extremely large, the service life may be reduced in a very short amount of time. Confirm that the operating conditions do not exceed the values in the following table.

(Contact a Tsubaki representative if the allowable values are accidentally exceeded.)

TKP Series	TKC Series	TKR Series	TK Series	TKS Series	TKH Series	TKI Series/TKV Series
2G	3G	2G	1 m/sec <sup>2</sup>	1 m/sec <sup>2</sup>	1 m/sec <sup>2</sup>	Contact a Tsubaki representative.

# Cable Carrier Handling

## Installation and maintenance

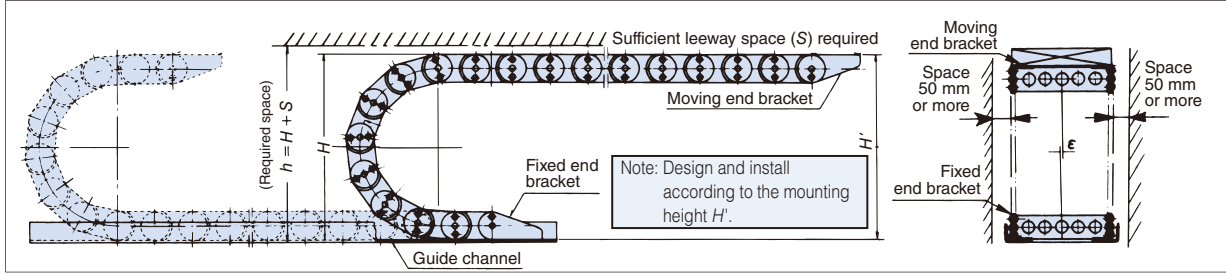

### ◆ Required space

To compensate for sag caused by cable carrier and cable mass, cable carriers will have pretension. However, the product should be installed at the mounting height  $H'$  and not the total cable carrier height  $H$ . Pretension and sagging will occur in the unsupported length portion depending on operating and environmental conditions. Be sure to ensure the required space referring to the figure above. Problems will not generally arise in the absence of interfering objects. Vibration may occur with increased operation speeds. If operation speeds exceed 70% of the max. allowable speed, double the  $S$  dimension.

Moreover, be sure to provide space on the inside of the cable carrier to account for sag that occurs in the unsupported length portion during use.

Model	$\epsilon$ or less	$S$ (mm)	$H'$ (mm)
TKP13H10, TKP17H11, TKP18H14/15, TKP25H15	3	50	$H + (10 \text{ to } 30)$
TKP35H22, TKP45H25	4	100	
TKP Series other than above	6	100	
TKC Series	6	100	
TKR15H22	6	100	
TKR20H28, TKR26H40, TKR28H52, TKR37H28	6	100	$H + (30 \text{ to } 50)$
TKO70, TKSO70	4	100	$H + 10$
TKO95, TKSO95	6		
TK130	8		
TK180	10		
TKH250	15		
TKF055, TKF085	8	100	$H + 30$
TKF115	10		
TKF175	10		

Misalignment ( $\epsilon$ ):  
Moving end bracket and fixed end bracket mounting position differences

$H'$ : Mounting height  
 $H$ : Total cable carrier height  
 $h$ : Height of required space

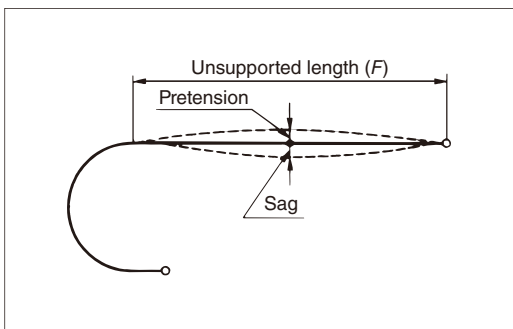

Straight types (special type) that have no pretension are also available.

### ◆ Cable carrier guide

A guide channel is required for use with cable carriers. Referring to the table below, construct a guide using steel plates or steel angles.

To ensure smooth operation, chamfer and grade the sections where the cable carrier moves in and out of.

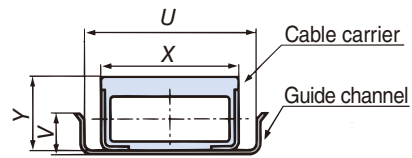

$X$  = Cable carrier outer width  
 $Y$  = Cable carrier outer height

Model	$U$ (mm)	$V$ (mm)
TKP13H10, TKP17H11, TKP18H14/15, TKP25H15	$X + 10$	$\frac{Y}{2}$ or more
TKP35H22, TKP45H25	$X + 15$	
TKP Series other than above	$X + 20$	
TKC Series		
TKR Series		
TK Series/TKS Series/TKH Series	$X + 20$	$\frac{Y}{3}$
TKF Series		

### ◆ Lubrication

In principle, the cable carrier does not need to be lubricated. However, when using TK Series, TKS Series, TKH Series, or TKV Series in environments prone to rusting, protect against rust by applying grease to link portions or through some other means.

Please note that lubrication is required for TKI Series.

### ◆ Precautions for special applications

1. Install support rollers or side guides to prevent collapse when lateral loads are applied such as during ceiling crane running.
2. Take care to prevent vibrations from the machine being transmitted to the cable carrier if external vibrations from manipulators, rock drills, or other equipment are a concern. (Shock absorbers, etc.)

### ◆ Storage following device installation

If the equipment will be stored following installation, fix the moving end of the cable carrier so that it is at the end of its reverse stroke to prevent sag in the unsupported length portion due to creeping. Moreover, use supports or some other means to hold the center unsupported length portion if not possible given the system structure.

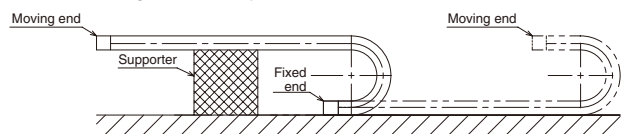

## Precautions when fabricating glide channels

Observe the following precautions when you fabricate glide channels. Convenient, easy to install glide channels are also available. (Page 117)

### Description of terms

- Push type : The cable carrier is moved by applying a force that pushes the moving end bracket in the direction of the bending radius.
- Pull type : The cable carrier is moved in the direction opposite of that described above (the cable carrier is extended).
- Buckling : A section of the channel on which the cable carrier slides that bulges out in the middle of push-type cable carrier movement.
- H channel : A channel equipped with a platform installed in front of the fixed end bracket that the cable carrier is lifted onto and slides along.
- U channel : A channel installed behind the fixed end bracket that supports the cable carrier at floor level.

### 1. Materials

Guide channels restrict the lateral deviation in the moving direction of cable carriers, so use smooth steel sheet to reduce wear in particular. If the channels are painted for rust-proofing, the paint may peel off due to sliding and cause the cable carrier to become worn. Galvanized steel sheet or SUS304 is recommended as the material to use to fabricate channels. Use SUS304 when the channels will be used in an outdoor environment. Do not use the aluminum channels manufactured by Tsubaki in an outdoor environment.

### 2. Channel installation precision

Vertical deviation is within 5 mm either up or down per 5 m. The channels run in one direction without following a linear gradient. Deviation in the horizontal direction is within 3 mm either to the left or right per 5 m. The channels run in one direction without following a linear curve.

### 3. Bracket installation precision on both ends

Moving end side	Mounting height	: Within $\pm 10$ mm in relation to the full channel area	
	Lateral deviation in the moving direction of cable carriers	: Within $\pm 3$ mm in the full area in relation to the channel sidewalls	
Fixed end side	Mounting height	: Top surface of fixed end bracket is 0 to 1 mm in relation to the platform of the H channel	
	Parallellism	: Within $1^\circ$ in relation to the channel sidewalls	

### 4. Taper angle of upper channel surface

Fabricate the channels by giving the opening on the top of the channels a slope to the outside so that the cable carrier can be smoothly inserted into the channels. The bending angle is approximately  $15^\circ$  to  $20^\circ$  and the length is 30 mm or greater.

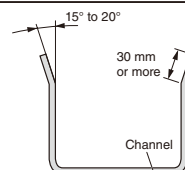

### 5. Structure of the transfer section for the fixed end bracket and channel

Give the transfer section of the H channel a slope so that the cable carrier transfers smoothly. The slope should be  $10^\circ$  or larger with a length of 30 mm or longer, and install the channel so the end touches the fixed end bracket. When using the Tsubaki dedicated aluminum channels, machine a 2-mm chamfer for the channel before installation.

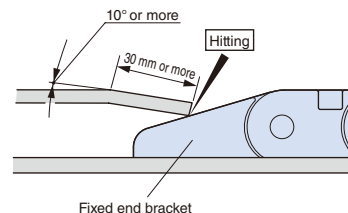

### 6. Fabricating channel joints

#### ◆ H channel

At both ends, bend the end section of the joint outward so the cable carrier does not catch. For the platform the cable carrier slides on, fit the channels tightly so there is no unevenness. When creating an opening at joints, make that opening within 5 mm and eliminate unevenness with a 2-mm chamfer. When using the Tsubaki dedicated aluminum channels, machine a 1-mm chamfer for sliding surface.

#### ◆ U channel

At both ends, bend the end section of the joint outward so the cable carrier does not catch. Install the channel so unevenness is within 1 mm. Chamfering and other machining is not required. However, ensure the surface is smooth without burrs and cuts are clean.

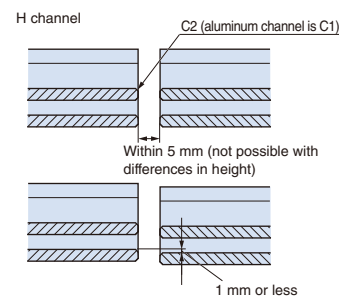

### 7. Full length of cables and hoses

If there is clearance between the joints (between link pins and pin holes) of the cable carrier and tension is generated, the length will become longer than the basic length. For the full length of cables and hoses, prepare those items with a certain amount of leeway and adjust the length in the actual cable carrier. The amount of stretching may be approximately 0.2 to 0.6% of the total length at maximum, so use appropriate caution with long lengths.

### 8. Examples of problems due to poorly fabricated channels

- ◆ Unevenness in the joints of sidewalls: The unevenness interferes with the bending section of the cable carrier. This causes damage to the cable carrier and wear due to buckling and sliding.
- ◆ Unevenness in joints at the bottom of channels: Abnormal wear will occur if there is unevenness between H channels. Buckling and localized wear will also occur if there is a large amount of unevenness between U channels.
- ◆ The platform of the H channel is higher than the top of the fixed end bracket: The cable carrier rides up on the channel when used as the pull type, so noise and abnormal wear may occur.
- ◆ Channels not level after installation: Buckling and increasing in sliding friction may occur.
- ◆ No clearance at the channel joint: The channel may be deformed and damaged due to thermal expansion if the temperature difference is large.

# Cable Carrier Handling

## Cable wiring and hose connections

1. Use highly flexible cables/hoses for movement offering excellent flexibility and durability over continuous operation.

Use of cables with wire-braided coating is prohibited. The sliding of the cable will cause damage to both the cable carrier and the wire-braiding coated cables. Do not use such cables under any circumstances.

2. Lay out the cables/hoses in a way that does not allow twisting to occur. Do not pull cables/hoses from a drum or spiral coil as doing so will cause the cable/hose to become twisted. (See Figure 1.)

Make sure the cables/hoses are straight when inserted into the cable carrier. (See Figure 2.)

3. Required cable/hose length  
Normally, a cable length of

$$(\text{Pitch} \times \text{No. of links}) + \text{Mounting area length} = \text{Required cable length}$$

is appropriate.

The length of a hose will change due to pressure during use, so

$$\{(\text{Pitch} \times \text{No. of links}) + \text{Mounting area length}\} \times 1.015 = \text{Required hose length}$$

is appropriate. Please note that a coefficient of 1.015 allows for hose shrinkage, but because this will depend on the type of hose, be sure to check with the hose manufacturer.

4. To prevent tension where cables/hoses bend from being pressed against the outer surface of the cable carrier, arrange the cables/hoses loosely (with enough space to "float" above the inner circumference surface inside the cable carrier) to allow freedom of movement. (See Figure 3 and Figure 4.)
5. To prevent unnecessary tension from being applied to the cable/hose, and to maintain the length within the cable carrier, use clamps for fixing at the moving end and the fixed end. (See Figure 5.)

Note that cables and hoses should not be fixed within the cable carrier.

6. Lay out the cables/hoses in a row horizontally so that they do not overlap. For models that allow dividers to be installed, use dividers when arranging the cables/hoses.
7. When using stayed systems for cables/hoses, note that the inner and outer circumferences are not the same. Ensure the required length along the center line for each of the cables/hoses is provided.

However, when using dividers to separate cables/hoses into stayed systems, the sliding of the cables/hoses will cause wear to occur more quickly. As such, it is recommended that the cables/hoses be arranged in a row horizontally.

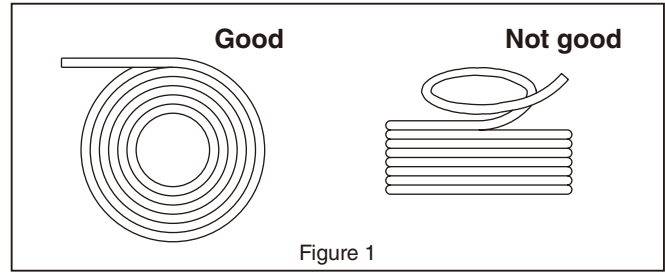

Figure 1

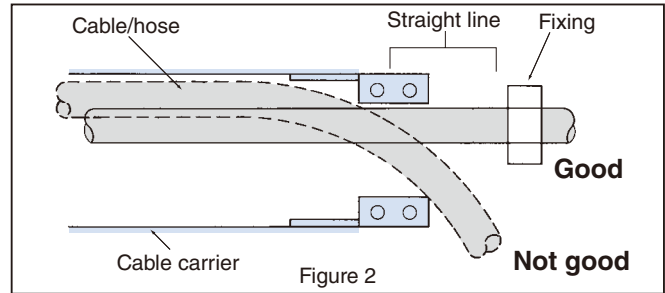

Figure 2

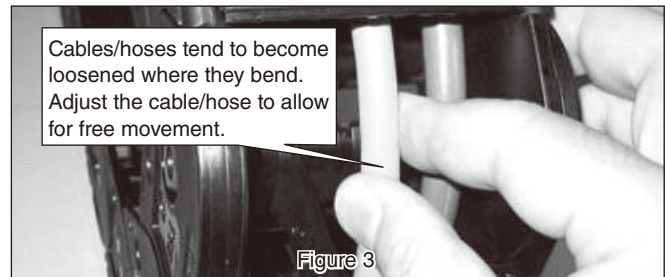

Figure 3

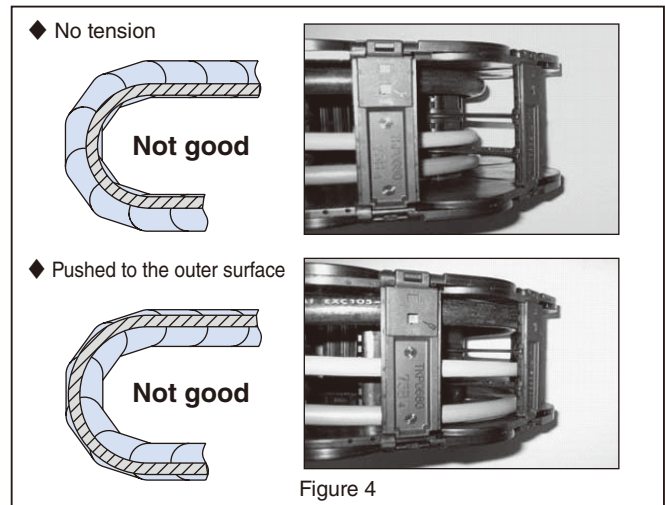

Figure 4

## Maintenance

- (1) The link or stay bolts may come loose due to vibrations during transportation or operation. Check these bolts regularly following operation. (TK Series/TKS Series/TKH Series)
- (2) Take care to prevent obstructions from falling onto or from adhering to the guide channel.
- (3) Check regularly for smooth back-and-forth operation of the cable carrier. Also check whether the cable/hose is being forcibly pulled or if continuous bending of the cable has caused the length to change within the cable carrier.

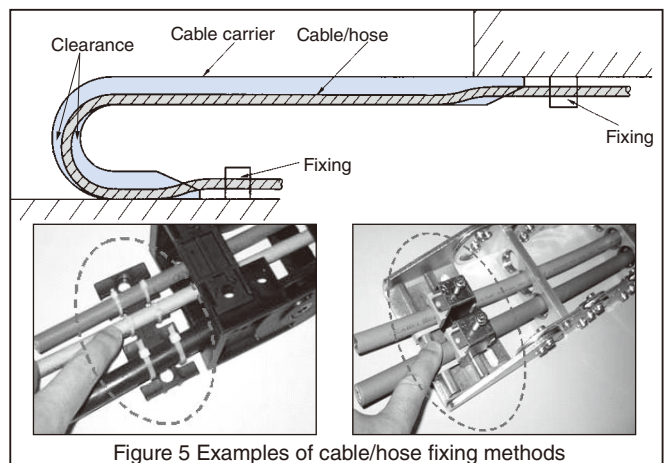

Figure 5 Examples of cable/hose fixing methods



# Cable Carrier Connecting/Assembly

## TKP Series

### 1. Connecting

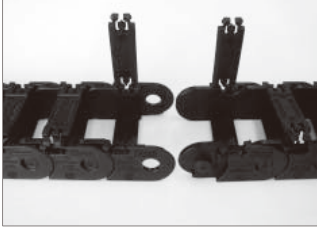

1.1 Arrange the stays in the disconnected direction.



1.2 Align pins and holes and push together.

### 2. Installing cables/hoses

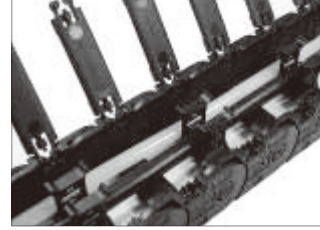

Close the stays after the setting the cables and hoses.

### 3. Separating

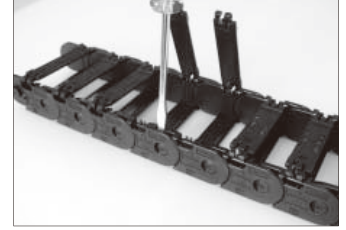

Insert a flathead screwdriver and turn 90° or raise and pry open.

## TKP62H42/TKP90H50/TKP125H74

### 1. Connecting

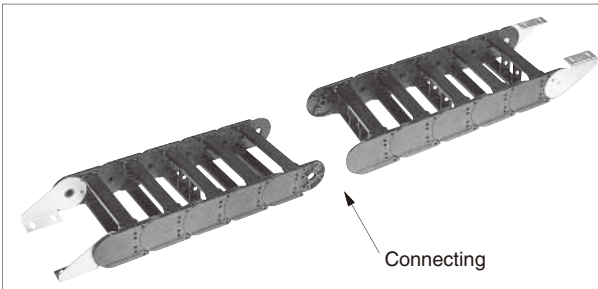

1.1 Remove 3 or 4 outside stays and lock stays at the connection.

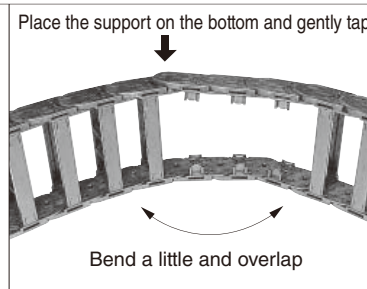

1.2 After connecting the links, install the lock stays.

### 2. Installing cables/hoses

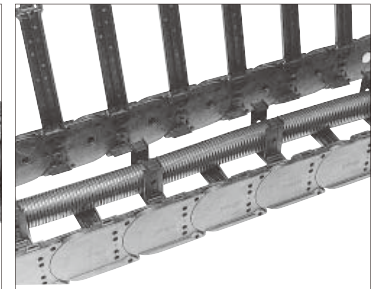

Close the outside stays after the setting the cables and hoses.

\* Connecting and assembling the TKP Series depends on the structure. Refer to the appropriate instruction manual.

## TKC Series

### 1. Connecting

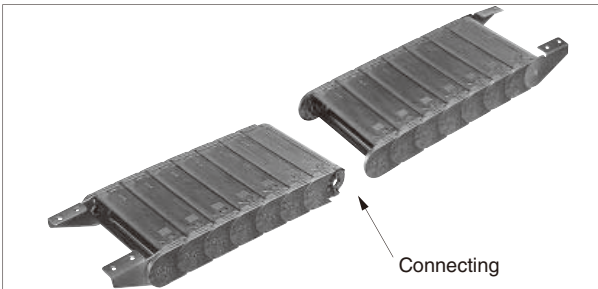

1.1 Remove 3 or 4 outside stays and lock stays at the connection.

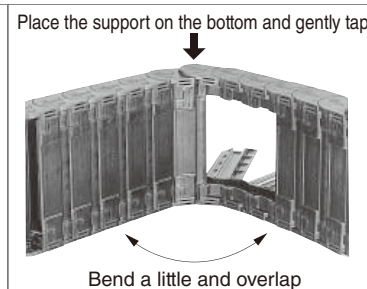

1.2 After connecting the links, install the lock stays.

### 2. Installing cables/hoses

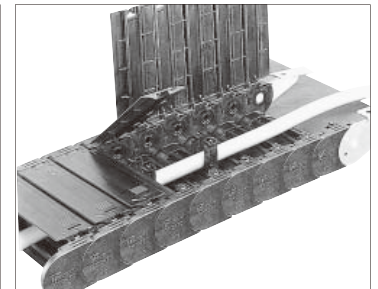

Close the outside stays after the setting the cables and hoses.

\* Lock stay removal guide mark (screwdriver mark)

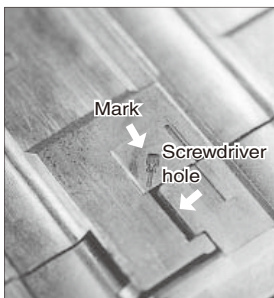

For the TKC34H25

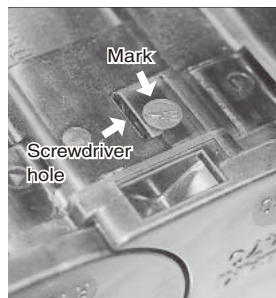

For the TKC47H36/  
TKC64H50/TKC85H68

\* Lock stay installing guide mark (mark to match to link)

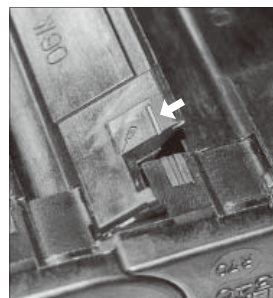

For the TKC34H25

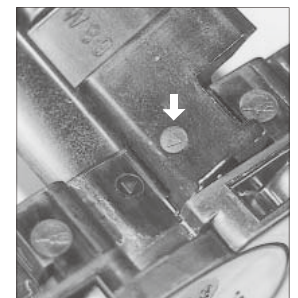

For the TKC47H36/  
TKC64H50/TKC85H68

# Cable Carrier Connecting/Assembly

## TKR15H22

Connecting (Use the same procedure to install brackets)

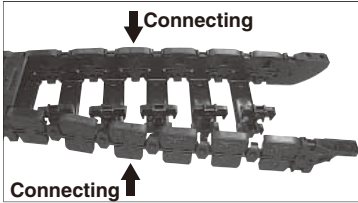

1. Remove the stays and inner links.

\* Remove 2 more from the bracket on the side to extend to the connector for the outer links.

\* Remove the inner link.

1.1 Unlock for outside 1.2 Unlock for inside

Flathead screwdriver  
(Tip width: 3 mm or less)

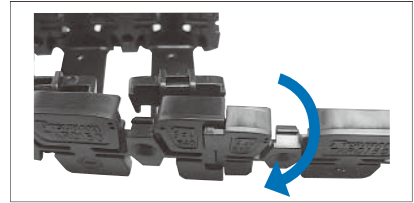

2. Separate the cable carrier between the outer links up to the connector for the outer links.



3. Connect the extension outer links.

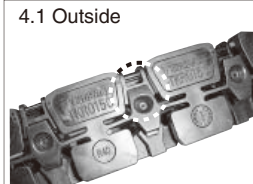

4.1 Outside



4.2 Inside

4. Install the inner links to the outer link.

\* Push the hook of the outer link into the gap on the inner links. (Outside → inside order)



5. Install all inner links to one side of the outer link, and then install the inner links to the opposite side of the outer link.

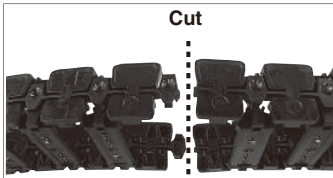

6. Separate the outer link at the specified number of links.

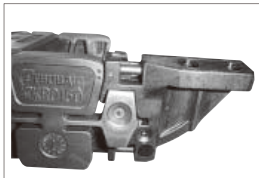

7. Install the bracket to the cut portion of the outer link.



8. Install stays to the plastic link section and bracket.

## TKR20H28/TKR26H40/TKR28H52

1. Connecting (Use the same procedure to install brackets)

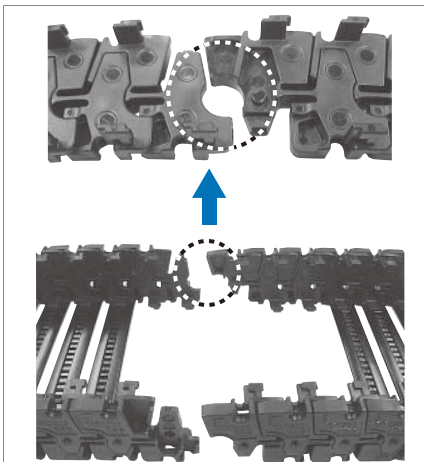

1.1 Remove 2 links worth of outside stays and lock stays from the end of the connection and adjust the direction.

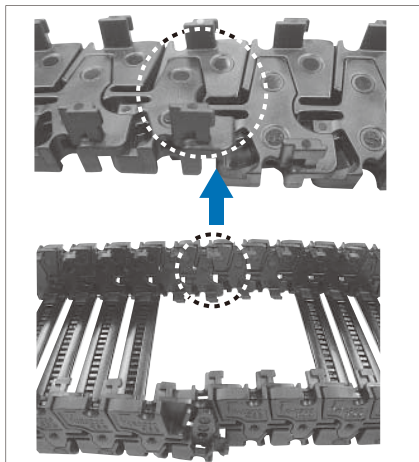

1.2 Fit the protrusion on the outside of the links into the depression on the links.

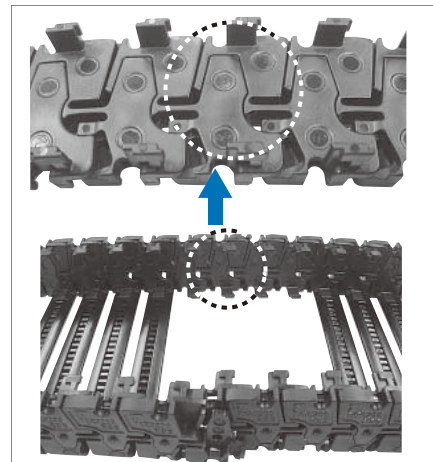

1.3 Fit the inside of the links in the same manner.

2. Separating

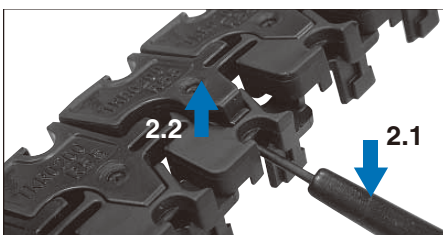

2.1 Insert a flathead screwdriver (tip width: 3.5 mm or lower) into the hold on the inside of the link, and pry open in the direction of the arrows.

2.2 The links are unlocked and can be removed.

## TK Series/TKH Series/TKS Series

### 1. Connecting

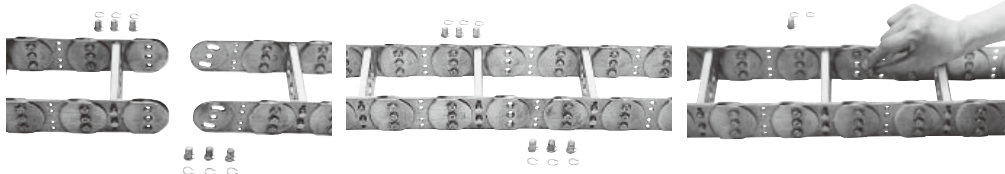

1.1 Place the cable carrier on the floor with the outside down.

1.2 Align the pins.

1.3 Install the pins and lock with circlips.

**Note:**  
The cable carrier has pretension, so both ends lift up when the outside is placed down on the floor. In this case, place blocks under both ends and align the pins.

### 2. Installing cables/hoses

#### ◆ For the TK Series/TKH Series (split stay)

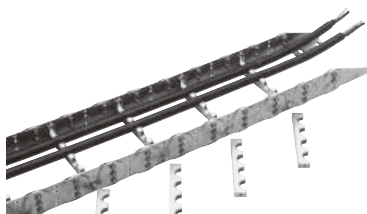

- 2.1 Remove the inside stay. (If it is difficult to remove or install the stay, loosen the other bolt.)
- 2.2 Place the cables and hoses in the prescribed indentations on the stay.
- 2.3 Install and temporarily fasten the inside stay. Always install the one end of the removed stay in its original position (match the symbols).

- ◆ For an unsplit stay, install the cables and hoses through the stay holes from one end of the cable carrier.
- ◆ The stay has a mark inscribed on its outside.

#### ◆ For the TKS Series

Twist the inside bar 90° to remove.

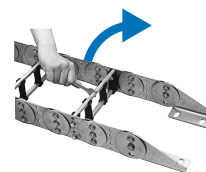

### 3. Adjustments and tightening

When finished installing the cables and hoses and temporarily fastening the stays, place the cable carrier down on a level floor as shown in the following photo, and tighten the stay installing bolts.



**⚠** Be careful so that twisting does not occur between links in step 2. If the cables and hoses are not installed while the cable carrier is flat, the cable carrier may twist or meander when installed in the equipment.

# Cable Carrier Usage Limitations

## Cable carrier service life

1. As the cable carrier moves (cycles), the pins and holes in the link connections will wear or the no-back-bend limiting portion will wear, causing sag in the unsupported length portion (see the figure to the right). This will result in the product being determined as having reached the end of its service life when it is no longer possible to guarantee protection of the cables/hoses and stable operation of the cable carrier. This determination is made when the smaller of 1.1 or 1.2 below is reached.

Unsupported length sag limits (guideline)

- 1.1 10% of unsupported length
- 1.2 Cable carrier bending radius ( $R$ ) amount

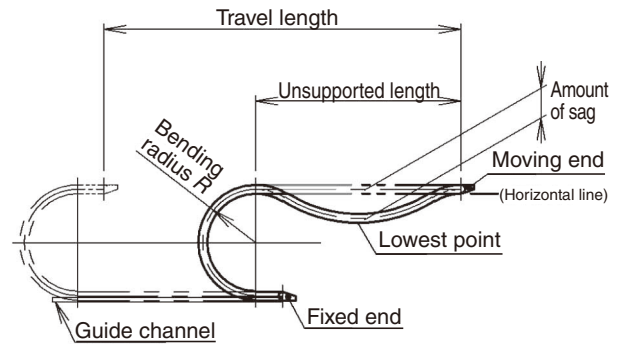

(Ex.) Unsupported length: 500 mm ( $\Rightarrow 500 \text{ mm} \times 10\% = 50 \text{ mm}$ )  
 Cable carrier bending radius: R55 } Sag amount limit (guideline): 50 mm

2. Should the cable carrier become broken, cracked, or otherwise damaged due to deterioration caused by age, the cable carrier is determined to have reached the end of its service life.

## Factors that affect service life

A cable carrier may reach the end of its service life relatively quickly in the following cases:

1. High acceleration/deceleration or operating frequency.
2. Presence of wear caused by abrasives such as dust.
3. External vibrations.
4. Poor installation.
5. Temperature and humidity of the cable carrier installation environment (hot and/or humid).

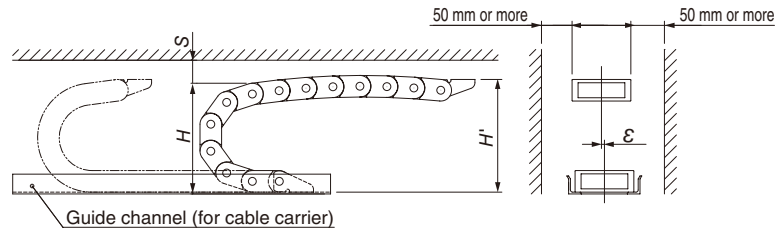

### ◆ Cable carrier installation accuracy guidelines (recommended)

- Misalignment ( $\epsilon$ ) of moving end and fixed end positions is smaller than the allowable value
- Mounting height ( $H'$ ) is within the recommended value range (Note: Do not install at the total height ( $H$ )).
- Leeway space ( $S$ ) is larger than the recommended value
- Provide a guide channel (for cable carrier)

## Prolonging cable carrier service life

To prolong the service life of cable carrier components, installation of support rollers or support plates from the start of operation is recommended to limit sag.

Note: When adding support rollers or support plates if the sag amount in the unsupported length portion is increasing, the installation position (height) or—for support plates—the shape (where the unsupported length portion transfers to the channel) must be set with consideration for the amount of sag in the unsupported length portion at that time.

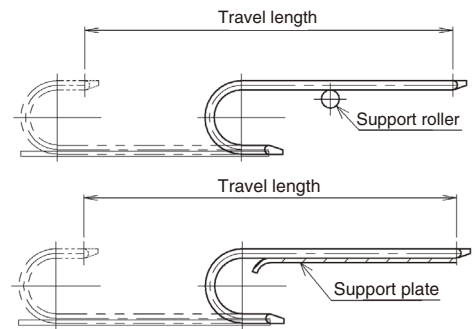

## Guideline for the service life of the gliding arrangement

With the gliding arrangement, the inside of the link wears down with usage. The guideline for replacement is when the amount of link height wear (amount of gliding shoe wear for gliding shoes) reaches the allowable value (table to right). For the TKP58H39 with gliding shoes, TKP68H46 with gliding shoes, TKP91 (H56, H80), and TKC91 (H56, H80), only the gliding shoes can be replaced.

For the effect of prolonging the service life of gliding shoes, refer to page 128.

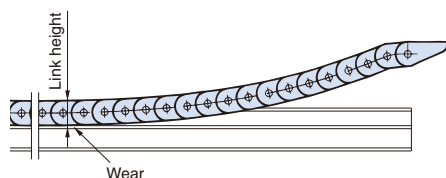

Model	Allowable wear (mm)	
	No gliding shoes	With a gliding shoe
TKP35H22	1.0	-
TKP45H25	1.5	-
TKP58H39	1.5	5.0
TKP62H34	1.0	-
TKP68H46	1.5	5.0
TKP90H50	1.5	-
TKP91H56	-	7.0
TKP91H80	-	7.0
TKP125H74	1.5	-
TKC34H25	1.0	-
TKC47H36	1.0	-
TKC64H50	1.5	-
TKC85H68	1.5	-
TKC91H56	-	7.0
TKC91H80	-	7.0

Note: Types with even larger values (different gliding shoe thickness) are also available. Contact a Tsubaki representative for further information.

# Cable Carrier Inquiries Sheet

## ◆ Installation method (arrangement)

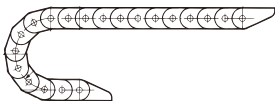

Standard arrangement

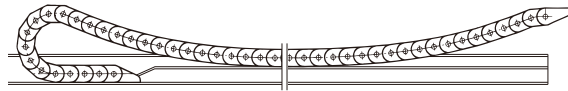

Gliding arrangement

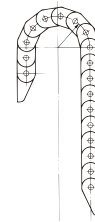

Vertical arrangement (standing)

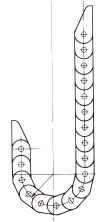

Vertical arrangement (hanging)

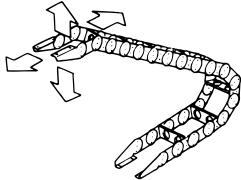

Horizontal-vertical combined arrangement

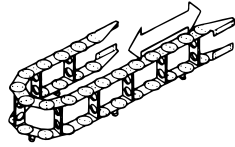

Side mount arrangement

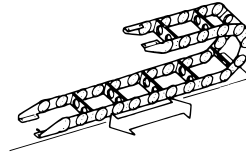

Top-fixed arrangement (bottom movement)

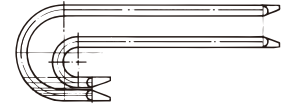

Nested arrangement

## ◆ Mounting space

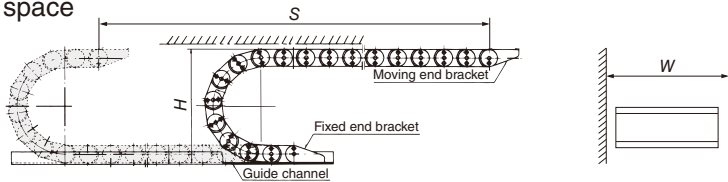

1. Max. travel length  $S$  \_\_\_\_\_ mm (For horizontal-vertical combined arrangement →
2. Allowable mounting height  $H$  \_\_\_\_\_ mm Max. multi-axis travel length \_\_\_\_\_ mm)
3. Allowable mounting width  $W$  \_\_\_\_\_ mm
4. Machine/Application \_\_\_\_\_
5. Operating environment
  - Temperature \_\_\_\_\_ °C
  - Humidity \_\_\_\_\_ %
  - Circle all relevant items.
 Dirt/Dust/Chips/Sand/Outdoors/Corrosive environment (acidic or alkaline)/Paint
6. Max. acceleration speed \_\_\_\_\_ m/s<sup>2</sup>
7. Travel speed \_\_\_\_\_ m/min
8. Frequency of use \_\_\_\_\_ times/day
9. Special remarks \_\_\_\_\_

## ■ Cable/hose types

	Types	Outer diameter	Mass (kg/m)	Number	Allowable bending radius
1	Cable/hose				
2	Cable/hose				
3	Cable/hose				
4	Cable/hose				
5	Cable/hose				
6	Cable/hose				
7	Cable/hose				

\* Separately write the types for the top and bottom cables/hoses for nested arrangement.

## ◆ Desired types

1. Material Plastic / Steel
2. Structure Open type / Closed type
3. Dividers Required / Not required

## ◆ Special remarks

Company name \_\_\_\_\_ Department \_\_\_\_\_  
 Name \_\_\_\_\_ Tel. \_\_\_\_\_  
 Date of submission \_\_\_\_\_ E-mail \_\_\_\_\_

# Cable Carrier Inquiries Sheet

## Horizontal circular travel arrangement

◆ Rotation angle  
\_\_\_\_\_ ° (degrees)

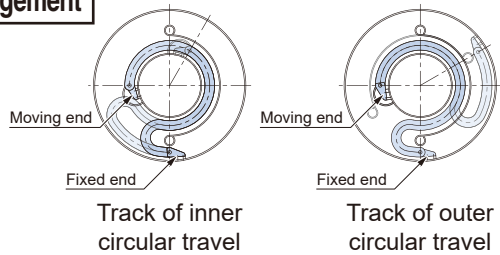

\* To specify the fixed end position, draw that position on the diagram above.  
\* Even if the rotation angle is the same, the number of links depends on the installation position of the moving and fixed ends.

- ◆ Moving end direction Inner circular travel side / Outer circular travel side
- ◆ Moving bracket Installed to guide channel wall / Moves by bracket only
- ◆ Guide channel floor Movable / Fixed
- ◆ Mounting space

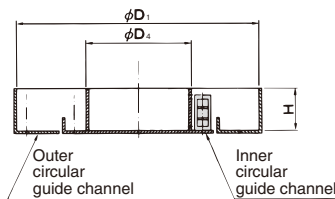

1. Outer circumference drum diameter  $D^1$  \_\_\_\_\_ mm
2. Inner circumference drum diameter  $D^2$  \_\_\_\_\_ mm
3. Guide channel height  $H$  \_\_\_\_\_ mm

4. Machine/Application \_\_\_\_\_

5. Operating environment

- Temperature \_\_\_\_\_ °C
- Humidity \_\_\_\_\_ %
- Circle all relevant items.

Dirt/Dust/Chips/Sand/Outdoors/Corrosive environment (acidic or alkaline)/Paint

6. Max. acceleration speed \_\_\_\_\_ m/s<sup>2</sup>

7. Travel speed \_\_\_\_\_ m/min

8. Frequency of use \_\_\_\_\_ times/day

9. Special remarks \_\_\_\_\_

## Vertical circular travel arrangement

◆ Rotation angle  
\_\_\_\_\_ ° (degrees)

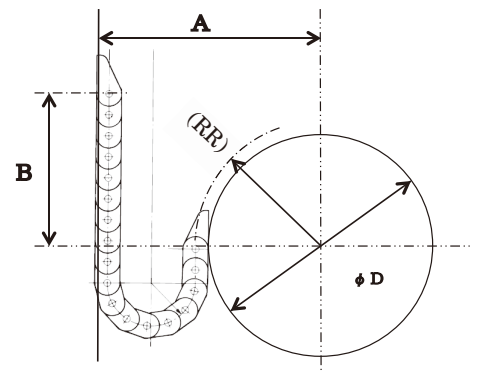

1. Drum diameter  $D$  \_\_\_\_\_ mm
2. Mounting width  $A$  \_\_\_\_\_ mm
3. Mounting height  $B$  \_\_\_\_\_ mm

## ■ Cable/hose types

	Types	Outer diameter	Mass (kg/m)	Number	Allowable bending radius
1	Cable/hose				
2	Cable/hose				
3	Cable/hose				
4	Cable/hose				
5	Cable/hose				
6	Cable/hose				
7	Cable/hose				

## ◆ Desired types

1. Material Plastic / Steel
2. Structure Open type
3. Dividers Required / Not required

## ◆ Special remarks

Company name \_\_\_\_\_ Department \_\_\_\_\_

Name \_\_\_\_\_ Tel. \_\_\_\_\_

Date of submission \_\_\_\_\_ E-mail \_\_\_\_\_

# For Safe Use



## Warning Observe the following points in order to prevent hazardous situations.

- Do not use the cable carrier and accessories (including CLEANVEYOR and FLATVEYOR) for anything other than their original purpose.
- Do not stand or ride on the cable carrier. There is a risk of damage and falls.
- Never perform additional work on the cable carrier or the accessories (except fitting connectors on CLEANVEYOR or FLATVEYOR).
  - Do not clean the cable carrier or the accessories with acids or alkalis, as they may cause cracking.
  - Never electroplate the cable carrier or the accessories, as this may cause cracking due to hydrogen embrittlement.
  - Do not weld the cable carrier or the accessories, as the heat may cause cracking or a reduction in strength.
- Observe all appropriate labor safety codes and standards for your region or area.
- When there is a need to replace a damaged (fractured) portion of a cable carrier or the accessories, always replace the whole cable carrier with a new product rather than replacing only the damaged or fractured portion.
- Immediately stop using the cable carrier or the accessories if it comes into contact with a substance that can cause embrittlement cracking (acid, strong alkali, battery fluid, etc.) and replace with new cable carrier or the accessories.
- Observe the following when connecting the cable carrier or the accessories, attaching and removing parts to and from the cable carrier or the accessories, and when performing maintenance and inspection on the cable carrier or the accessories.
  - Perform the procedure as specified in the instruction manual, catalog, or documentation specially provided to the customer.
  - Secure the cable carrier and parts so they do not move freely. The cable carrier may move on its own or collapse under its own weight.
  - Be careful not to pinch, crush or entangle hands in the bending section of the cable carrier.
  - Wear suitable clothing and protective equipment for the work (such as safety goggles, gloves and safety shoes).
  - Always turn off the source power supply beforehand, and take care not to accidentally operate switches.
  - Only experienced personnel should handle the cable carrier.

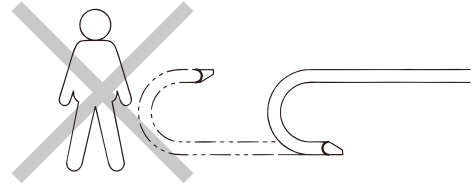
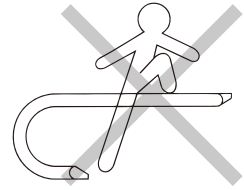

## Caution Observe the following points to prevent accidents.

- Carefully understand the construction and specifications of the cable carrier or the accessories before handling.
- Inspect the cable carrier or the accessories for damage during transport before installation.
- The cable carrier or the accessories should be periodically serviced and inspected.
- Cable carrier capacity varies according to manufacturer. When selecting a chain based on a Tsubaki catalog always use the corresponding Tsubaki product.
- Always ensure that the final customer receives the instruction manual.
  - If you do not have the instruction manual, contact a Tsubaki representative with the product name, series name, and chain/model number to receive the appropriate manual.
- The product information given in this catalog is mainly for selection purposes. Thoroughly read the instruction manual before actually using this product, and use the properly.

## Warranty

### 1. Warranty period without charge

Tsubakimoto Chain Co. (hereinafter referred to as "Company") provides a warranty without charge valid for either 18 months after the shipment of the purchased product (hereinafter referred to as "Goods") from the factory, or 12 months after the first use of Goods, whichever comes first. First use of Goods is considered to be the complete incorporation of Goods into the equipment of the purchasing party (hereinafter referred to as "Customer"). This warranty may be provided with charge in certain circumstances.

### 2. Warranty coverage

Should any malfunction in Goods arise during the warranty period, given that Goods were properly installed, operated, and maintained as instructed in the catalog, instruction manual, or similar, Company shall promptly deliver or repair Goods at no charge once Company has confirmed such failure. This warranty covers delivered Goods only and therefore does not include the following: ("Instruction manual or similar" includes documentation specially provided to Customer.)

- (1) Any costs required for the removal or installing of Goods from or into Customer's equipment for repair or replacement.
- (2) Costs required for transporting Customer's equipment to repair shop, etc.
- (3) Profits lost due to a malfunction or repair, or any other consequential loss.

### 3. Warranty with charge

Company will charge for any investigation, repair, and/or manufacturing of a malfunction in Goods (even during the warranty period) if caused by:

- (1) Improper location, installation (including cutting and connecting), lubrication, or maintenance by Customer's failing to follow the catalog, instruction manual, or similar. ("Instruction manual or similar" includes documentation specially provided to Customer.)
- (2) Operation methods (including operating conditions, operating environment, and allowable values) resulting from Customer's failure to follow operation described in the catalog, instruction manual, or similar. ("Instruction manual or similar" includes documentation specially provided to Customer.)
- (3) Inappropriate disassembly, modification, alteration, or processing by Customer.
- (4) Use of Goods by Customer in conjunction with damaged or worn parts not made by Company. (Ex: Use of Goods with sprocket, drum, rail, etc., that has a worn chain.)
- (5) Failure of operational life under operating conditions use as determined by Company to satisfy operational life covered by Warranty.
- (6) Use by Customer under conditions other than those discussed.
- (7) Consumption, wear, or deterioration of bearings, oil seals, oil, and other consumable parts incorporated into Goods.
- (8) Secondary failure or malfunction in Goods resulting from malfunctioning of Customer's equipment.
- (9) Malfunction of Goods resulting from a Force Majeure such as an act of God.
- (10) Malfunction of Goods resulting from a wrongful act committed by a third party.
- (11) Any other reason that is not attributable to Company.

The logos, brand names, or product names in this catalog are trademarks or registered trademarks of Tsubakimoto Chain Co. and/or its subsidiaries and/or affiliates in Japan and/or other countries.

The specifications of this catalog are subject to change without notice due to improvements or other reasons. Check the latest information at our website.



## TSUBAKIMOTO CHAIN CO.

Japan	Headquarters	+81 6-6441-0011	<a href="https://tsubakimoto.com/">https://tsubakimoto.com/</a>
-------	--------------	-----------------	---

### Global Group Companies

#### AMERICAS

United States of America	U.S. Tsubaki Power Transmission, LLC	+1 847-459-9500	<a href="https://www.ustsubaki.com/">https://www.ustsubaki.com/</a>
Brazil	Tsubaki Brasil Equipamentos Industriais Ltda.	+55 11-3253-5656	<a href="http://tsubaki.ind.br/">http://tsubaki.ind.br/</a>
Canada	Tsubaki of Canada Limited	+1 905-676-0400	<a href="http://tsubaki.ca/">http://tsubaki.ca/</a>

#### EUROPE

Netherlands	Tsubakimoto Europe B.V.	+31 78-6204000	<a href="https://tsubaki.eu/">https://tsubaki.eu/</a>
France	Kabelschlepp France S.A.R.L.	+33 1-34846365	<a href="https://kabelschlepp.fr/">https://kabelschlepp.fr/</a>
Germany	Tsubaki Deutschland GmbH	+49 89-2000-133-80	<a href="http://tsubaki.de/">http://tsubaki.de/</a>
	Tsubaki Kabelschlepp GmbH	+49 2762-4003-0	<a href="https://tsubaki-kabelschlepp.com/">https://tsubaki-kabelschlepp.com/</a>
Italy	Kabelschlepp Italia S.R.L.	+39 0331-350962	<a href="https://kabelschlepp.it/">https://kabelschlepp.it/</a>
Russia	OOO Tsubaki Kabelschlepp	+7 499-4180212	<a href="http://kabelschlepp.ru/">http://kabelschlepp.ru/</a>
Spain	Tsubaki Ibérica Power Transmission S.L.	+34 911-873450	<a href="http://tsubaki.es/">http://tsubaki.es/</a>
United Kingdom	Tsubakimoto U.K. Ltd.	+44 1623-688-700	<a href="https://tsubaki.eu/">https://tsubaki.eu/</a>

#### INDIAN OCEAN RIM

Singapore	Tsubakimoto Singapore Pte. Ltd.	+65 6861-0422/3/4	<a href="http://tsubaki.sg/">http://tsubaki.sg/</a>
Australia	Tsubaki Australia Pty. Limited	+61 2-9704-2500	<a href="http://tsubaki.com.au/">http://tsubaki.com.au/</a>
India	Tsubaki India Power Transmission Private Limited	+91 44-7101-2000	<a href="http://tsubaki.in/">http://tsubaki.in/</a>
Indonesia	PT. Tsubaki Indonesia Trading	+62 21-89458898	<a href="http://tsubakimoto.co.id/">http://tsubakimoto.co.id/</a>
Malaysia	Tsubaki Power Transmission (Malaysia) Sdn. Bhd.	+60 3-8966-2020	<a href="http://tsubaki.my/">http://tsubaki.my/</a>
New Zealand	Tsubaki Australia Pty. Limited - New Zealand Branch	+64 9-352-2085	<a href="http://tsubaki.com.au/">http://tsubaki.com.au/</a>
Philippines	Tsubakimoto Philippines Corporation	+63 2-8824-7519	<a href="http://tsubaki.ph/">http://tsubaki.ph/</a>
Thailand	Tsubakimoto (Thailand) Co., Ltd.	+66 2-262-0667/8/9	<a href="http://tsubaki.co.th/">http://tsubaki.co.th/</a>
Vietnam	Tsubakimoto Vietnam Co., Ltd.	+84 24-6274-1449	<a href="http://tsubaki.net.vn/">http://tsubaki.net.vn/</a>

#### EAST ASIA

Korea	Tsubakimoto Korea Co., Ltd.	+82 2-2183-0311	<a href="http://tsubakimoto-tck.co.kr/">http://tsubakimoto-tck.co.kr/</a>
Taiwan	Taiwan Tsubakimoto Co.	+886 3-3293827	<a href="https://tsubakimoto.tw/">https://tsubakimoto.tw/</a>

#### CHINA

China	Tsubakimoto Chain (Shanghai) Co., Ltd.	+86 21-53966651/2	<a href="http://tsubaki-sh.cn/">http://tsubaki-sh.cn/</a>
-------	--	-------------------	---



The Tsubaki Eco Link logo is used only on products that satisfy the standards for environmental friendliness set by the Tsubaki Group.

Distributed by: